

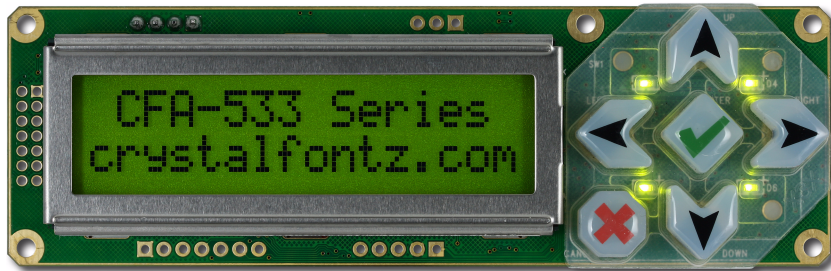

Crystalfontz America, Incorporated

INTELLIGENT USB LCD MODULE SPECIFICATIONS



Crystalfontz Model Number	CFA533-YYH-KU
Hardware Version	Revision 0.1, December 2007
Firmware Version	Revision u0.2, April 2009
Data Sheet Version	Revision 1.0, April 2009
Product Pages	http://www.crystalfontz.com/product/CFA533-YYH-KU

Crystalfontz America, Incorporated

12412 East Saltese Avenue
Spokane Valley, WA 99216-0357

Phone: 888-206-9720

Fax: 509-892-1203

Email: techinfo@crystalfontz.com

URL: www.crystalfontz.com



REVISION HISTORY

HARDWARE	
2007/12/31	Current hardware version: 0.1 New module

FIRMWARE	
2009/04/15	Current firmware version: u0.2 New firmware.

DATA SHEET	
2009/04/15	Current Data Sheet version: 1.0 New Data Sheet.

The Fine Print

Certain applications using CrystalFontz America, Inc. products may involve potential risks of death, personal injury, or severe property or environmental damage ("Critical Applications"). CRYSTALFONTZ AMERICA, INC. PRODUCTS ARE NOT DESIGNED, INTENDED, AUTHORIZED, OR WARRANTED TO BE SUITABLE FOR USE IN LIFE-SUPPORT APPLICATIONS, DEVICES OR SYSTEMS OR OTHER CRITICAL APPLICATIONS. Inclusion of CrystalFontz America, Inc. products in such applications is understood to be fully at the risk of the customer. In order to minimize risks associated with customer applications, adequate design and operating safeguards should be provided by the customer to minimize inherent or procedural hazard. Please contact us if you have any questions concerning potential risk applications.

CrystalFontz America, Inc. assumes no liability for applications assistance, customer product design, software performance, or infringements of patents or services described herein. Nor does CrystalFontz America, Inc. warrant or represent that any license, either express or implied, is granted under any patent right, copyright, or other intellectual property right of CrystalFontz America, Inc. covering or relating to any combination, machine, or process in which our products or services might be or are used.

The information in this publication is deemed accurate but is not guaranteed.

Company and product names mentioned in this publication are trademarks or registered trademarks of their respective owners.

Copyright © 2009 by CrystalFontz America, Inc., 12412 East Saltese Avenue, Spokane Valley, WA 99216-0357 U.S.A.



CONTENTS

MAIN FEATURES	6
Comparison to CFA-633	6
Features	6
Module Classification Information	7
Ordering Information	8
MECHANICAL SPECIFICATIONS	9
Physical Characteristics	9
Module Outline Drawings	10
Keypad Detail Drawing	12
Panel Mounting Application Cutout Drawing	13
ELECTRICAL SPECIFICATIONS	14
System Block Diagram	14
Supply Voltages and Current	15
Temperature Range	17
ESD (Electro-Static Discharge) Specifications	17
ATX POWER SUPPLY POWER AND CONTROL CONNECTIONS	17
POWER CONNECTIONS THROUGH USB	20
GPIO CONNECTIONS	21
DALLAS SEMICONDUCTOR 1-WIRE DEVICE CONNECTIONS	23
Other 1-Wire Devices	23
Host Communications	24
Packet Structure	24
About Handshaking	25
Report Codes	25
0x80: Key Activity	25
0x82: Temperature Sensor Report	26
Command Codes	27
0 (0x00): Ping Command	27
1 (0x01): Get Hardware & Firmware Version	27
2 (0x02): Write User Flash Area	27
3 (0x03): Read User Flash Area	27
4 (0x04): Store Current State as Boot State	28
5 (0x05): Reboot CFA-533, Reset Host, or Power Off Host	28
6 (0x06): Clear LCD Screen	29
7 (0x07): Set LCD Contents, Line 1	29
8 (0x08): Set LCD Contents, Line 2	30
9 (0x09): Set LCD Special Character Data	30
10 (0x0A): Read 8 Bytes of LCD Memory	30
11 (0x0B): Set LCD Cursor Position	31
12 (0x0C): Set LCD Cursor Style	31
13 (0x0D): Set LCD Contrast	31
14 (0x0E): Set LCD & Keypad Backlight	32
18 (0x12): Read DOW Device Information	33
19 (0x13): Set Up Temperature Reporting	34



CONTENTS, CONTINUED

20 (0x14): Arbitrary DOW Transaction	35
21 (0x15): Set Up Live Temperature Display	36
22 (0x16): Send Command Directly to the LCD Controller	36
23 (0x17): Configure Key Reporting	37
24 (0x18): Read Keypad, Polled Mode	37
28 (0x1C): Set ATX Switch Functionality	39
29 (0x1D): Enable/Feed Host Watchdog Reset	41
30 (0x1E): Read Reporting/ATX/Watchdog (debug)	41
31 (0x1F): Send Data to LCD	42
33 (0x21): Set Baud Rate	42
34 (0x22): Set/Configure GPIO	43
35 (0x23): Read GPIO & Configuration	44
CHARACTER GENERATOR ROM (CGROM)	46
JUMPER LOCATIONS AND FUNCTIONS	47
MODULE RELIABILITY AND LONGEVITY	48
Module Reliability	48
Module Longevity (EOL / Replacement Policy)	48
CARE AND HANDLING PRECAUTIONS	48
APPENDIX A: QUALITY ASSURANCE STANDARDS	50
APPENDIX B: CALCULATING THE CRC	56
Algorithm 1: "C" Table Implementation	56
Algorithm 2: "C" Bit Shift Implementation	57
Algorithm 2B: "C" Improved Bit Shift Implementation	58
Algorithm 3: "PIC Assembly" Bit Shift Implementation	58
Algorithm 4: "Visual Basic" Table Implementation	60
Algorithm 5: "Java" Table Implementation	62
Algorithm 6: "Perl" Table Implementation	63
APPENDIX C: CONNECTING A DS2450 1-WIRE QUAD A/D CONVERTER	65



LIST OF FIGURES

Figure 1. CFA533-YYH-KU Module Outline Drawing (two pages) -----	10
Figure 2. Keypad Detail Drawing -----	12
Figure 3. Panel Mounting Application Cutout Drawing -----	13
Figure 4. System Block Diagram -----	14
Figure 5. CFA533-YYH-KU Supply Current vs. Supply Voltage-----	16
Figure 6. CFA533-YYH-KU ATX Power Supply and Control Connections -----	19
Figure 7. CFA533-YYH-KU Power Connections through USB -----	21
Figure 8. GPIO Connections -----	22
Figure 9. CFA533-YYH-KU Connection for Dallas Semiconductor 1-Wire (DOW) Devices -----	23
Figure 10. Character Generator ROM (CGROM) -----	46
Figure 11. Jumper Locations and Functions -----	47



MAIN FEATURES

COMPARISON TO CFA-633

DESCRIPTION	CFA-533	CFA-633
Power supply	Single supply, +3.3 to +5.0	+5v and +12v both needed
Read up to 32 temperature sensors	Yes	Yes
Control up to 4 fans	No	Yes
Display and keypad backlights can be adjusted separately	Yes	No
Available standard interfaces	1. I ² C 2. Full swing RS-232 3. Inverted Logic Level RS-232 (UART) 4. USB	1. Full swing RS-232 2. Inverted Logic Level RS-232 (UART) 3. USB

FEATURES

- Wide power supply voltage range ($V_{DD} = +3.3v$ to $+5.0v$) is perfect for embedded systems.
- The contrast and backlights are fully compensated over the supply voltage range. No adjustments are needed to be made to the contrast setting or backlight brightness over the full range of power supply input voltage.
- Only a single supply is needed.
- The CFA-533 series mechanical and command set is compatible with the [CFA-633](#) series. CFA-533 will “drop-in” for most applications that do not use the CFA-633's fan capabilities.
- Very compact: 16x2 LCD, keypad and high-level interface fits in a 1U rack mount case (35 mm overall height).
- Full-speed USB interface.
- Edge-lit yellow-green LED backlight with positive yellow-green STN LCD (displays dark characters on yellow background). Integrated yellow LED backlit 6-button translucent silicon keypad.
- Positive mode display is sunlight readable and also readable in dark areas.
- 5.25-inch half-height drive-bay [CFA-533/CFA-633 Serial/USB LCD Mounting Bracket](#) available (optional).
- Fully decoded keypad: any key combination is valid and unique.
- Robust packet-based communications protocol with 16-bit CRC.
- Nonvolatile memory capability (EEPROM):
 - Customize the “power-on” display settings.
 - 16-byte “scratch” register for storing data such as IP address, netmask, system serial number . . .
- Optional capabilities. CrystalFontz can make these modifications for you. A semi-custom part number and minimum order may apply.
 - ATX power supply control functionality allows the buttons on the CFA533-YYH-KU to replace the “power” and “reset” switches on your system, simplifying front panel design. The ATX functionality can also implement a hardware watchdog which can reset host-on-host software failure.
 - Temperature monitoring: up to 32 channels at up to 0.5 degrees Celsius with absolute accuracy (using optional connector and CrystalFontz [WR-DOW-Y17](#) cable with Dallas 1-Wire sensor).



- “Live Display” shows up to four temperature readings without host intervention, allowing temperatures to be shown immediately at boot, even before the host operating system is loaded.
- RS-232 to Dallas Semiconductor 1-Wire bridge functionality allows control of other 1-Wire compatible devices (ADC, voltage monitoring, current monitoring, RTC, GPIO, counters, identification/encryption). (Additional hardware required.)









MODULE CLASSIFICATION INFORMATION

CFA - 533 - Y Y H - K U
① ② ③ ④ ⑤ ⑥ ⑦

①	Brand	Crystalfontz America, Inc.
②	Model Identifier	533
③	Backlight Type & Color	Y – LED, yellow-green
④	Fluid Type, Image (positive or negative), & LCD Glass Color	Y – STN, positive yellow-green
⑤	Polarizer Film Type, Temperature Range, & View Angle (O 'Clock)	H – Transflective, WT, 6:00
⑥	Special Codes 1	K – Manufacturer's codes
⑦	Special Codes 2	U – USB interface

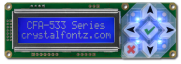

ORDERING INFORMATION

PART NUMBER	FLUID	LCD GLASS COLOR	IMAGE	POLARIZER FILM	BACKLIGHT COLOR/TYPE
CFA533-YYH-KU (USB)	STN	yellow-green	positive	transflective	LCD: yellow-green edge LEDs Keypad: yellow-green LEDs 
CFA533-TMI-KI* (I ² C)	STN	blue	negative	transmissive	LCD: white edge LEDs Keypad: blue LEDs 
CFA533-TMI-KL ("logic-level" RS-232)	STN	blue	negative	transmissive	LCD: white edge LEDs Keypad: blue LEDs 
CFA533-TMI-KS ("full swing" RS-232)	STN	blue	negative	transmissive	LCD: white edge LEDs Keypad: blue LEDs 
CFA533-TMI-KU (USB)	STN	blue	negative	transmissive	LCD: white edge LEDs Keypad: blue LEDs 
CFA533-YYH-KI* (I ² C)	STN	yellow-green	positive	transflective	LCD: yellow-green edge LEDs Keypad: yellow-green LEDs 
CFA533-YYH-KL ("logic-level" RS-232)	STN	yellow-green	positive	transflective	LCD: yellow-green edge LEDs Keypad: yellow-green LEDs 
CFA533-YYH-KS ("full swing" RS-232)	STN	yellow-green	positive	transflective	LCD: yellow-green edge LEDs Keypad: yellow-green LEDs 

*Semi-custom part number and minimum order may apply.



MECHANICAL SPECIFICATIONS

PHYSICAL CHARACTERISTICS

ITEM	SIZE
Module Dimensions – Width and Height	110.5 (W) x 35.0 (H) mm
Module Dimension – Depth:	
Without Keypad	11.1 mm
With Keypad	15.1 mm
Viewing Area	61.0 (W) x 15.8 (H) mm
Active Area	56.2 (W) x 11.5 (H) mm
Character Size	2.95 (W) x 5.55 (H) mm
Character Pitch	3.55 (W) x 5.95 (H) mm
Pixel Size	0.55 (W) x 0.65 (H) mm
Pixel Pitch	0.60 (W) x 0.70 (H) mm
Keystroke Travel (approximate)	2.4 mm
Weight	40 grams (typical)



MODULE OUTLINE DRAWINGS

Figure 1. CFA533-YYH-KU Module Outline Drawing (two pages)

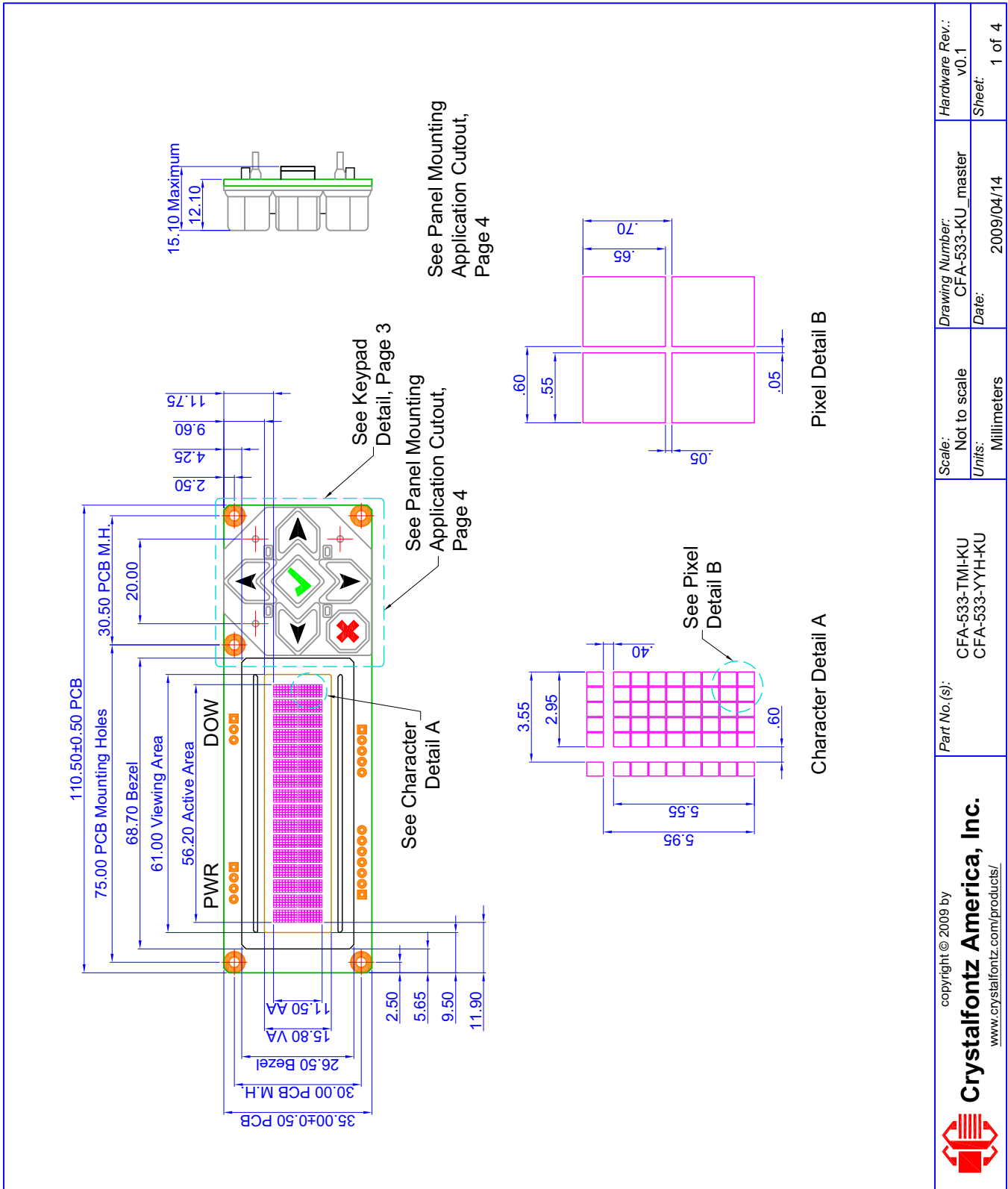

copyright © 2009 by Crystalfontz America, Inc. www.crystalfontz.com/products/	Part No. (s):	CFA-533-TMI-KU CFA-533-YYH-KU	Scale:	Not to scale	Drawing Number:	CFA-533-KU_master	Hardware Rev.:	v0.1
			Units:	Millimeters	Date:	2009/04/14	Sheet:	1 of 4

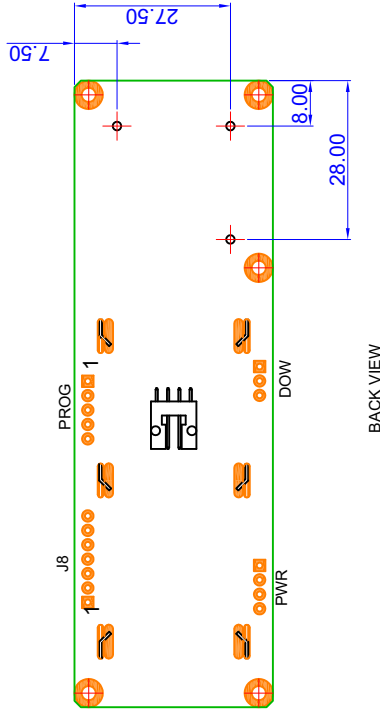
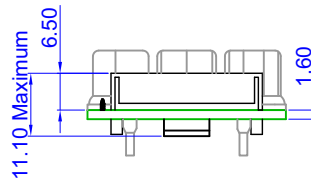
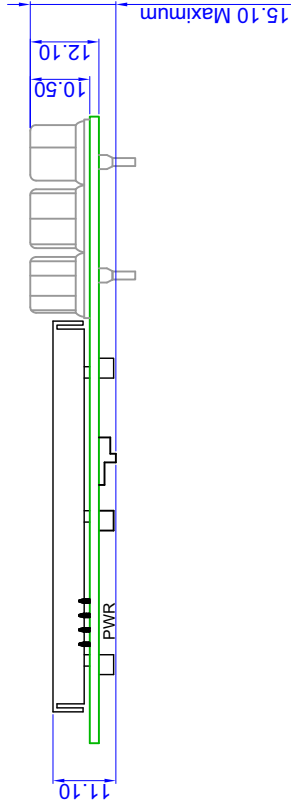

BACK VIEW



KEYPAD DETAIL DRAWING

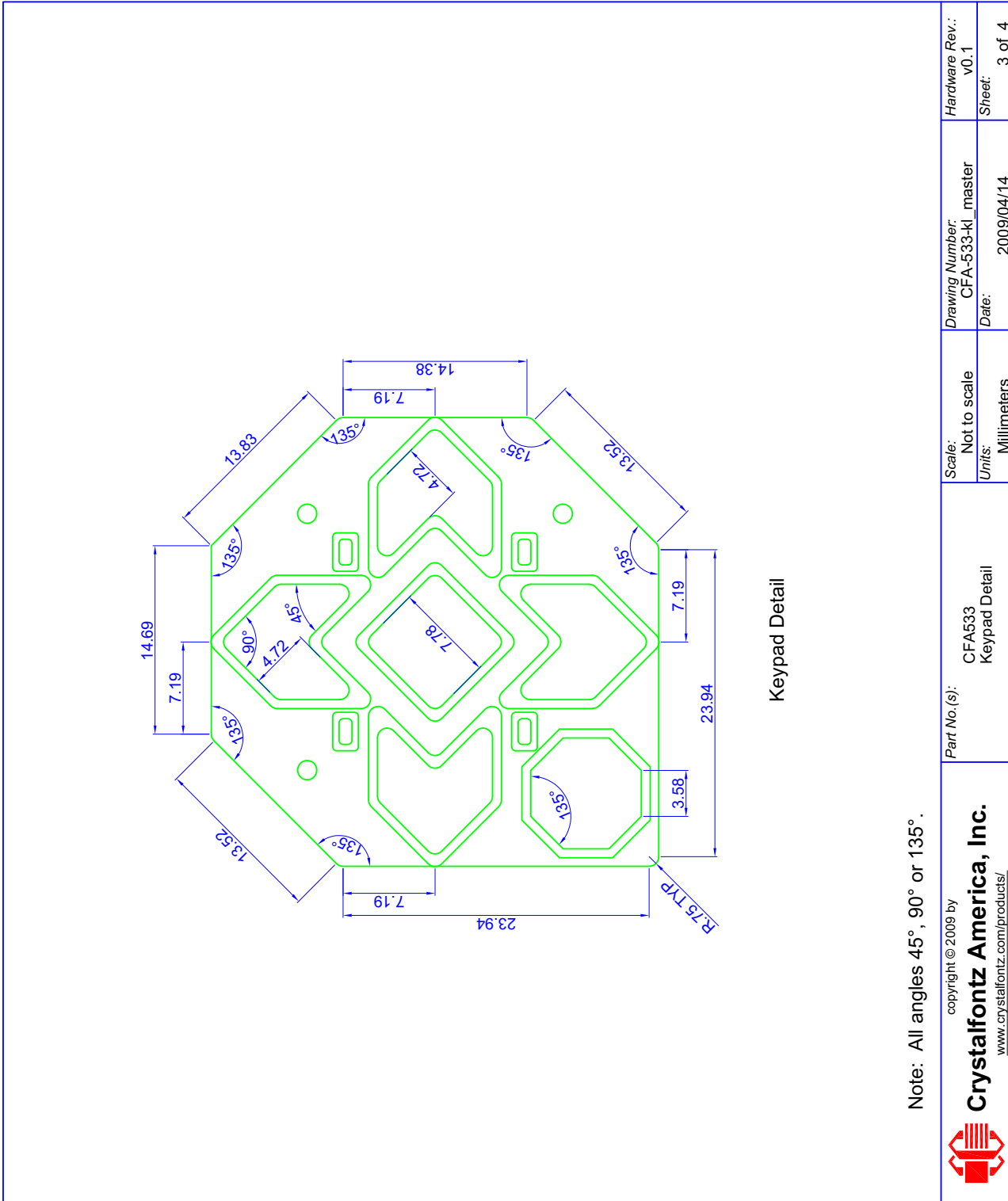

Figure 2. Keypad Detail Drawing



PANEL MOUNTING APPLICATION CUTOUT DRAWING

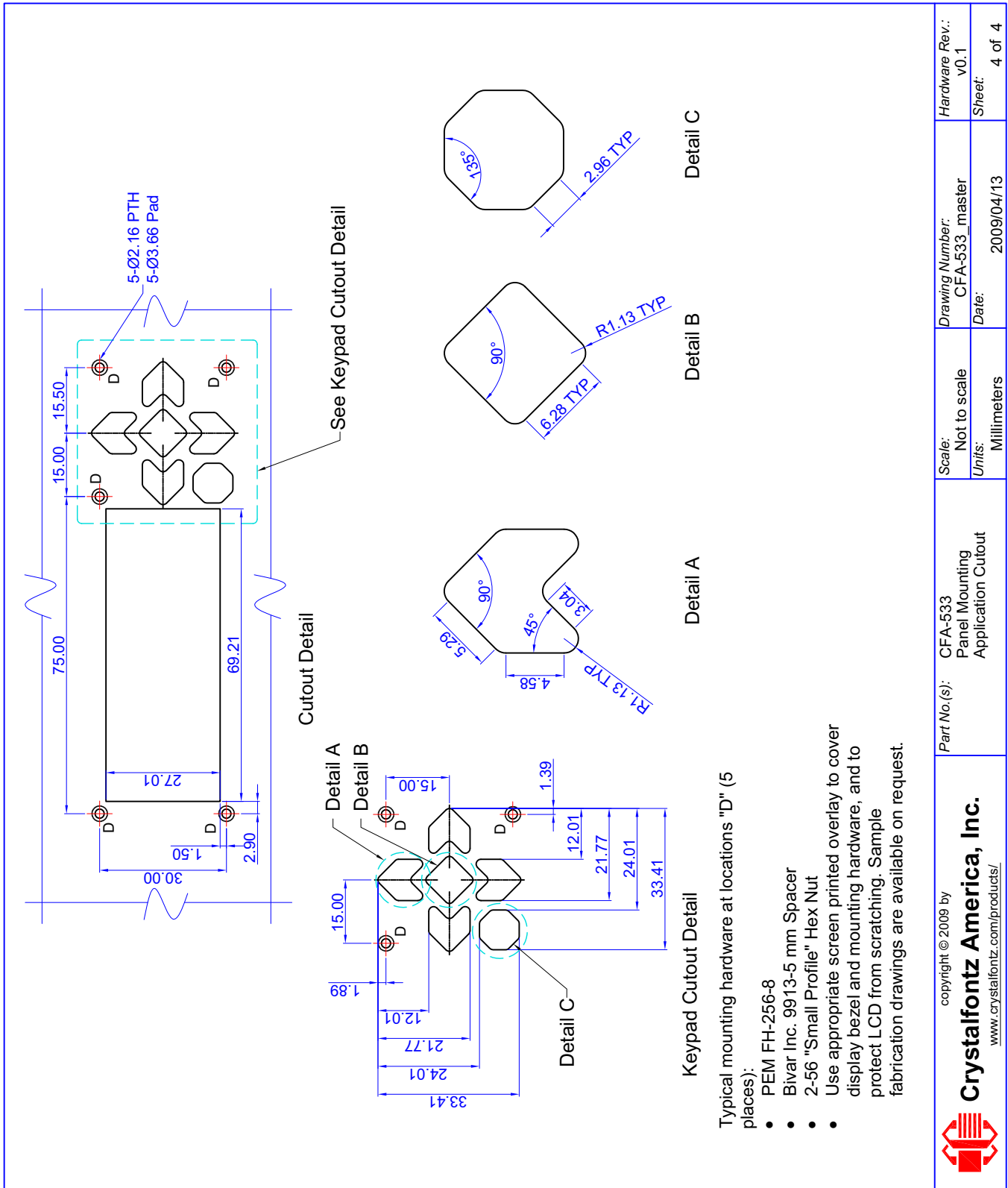

Figure 3. Panel Mounting Application Cutout Drawing



ELECTRICAL SPECIFICATIONS

SYSTEM BLOCK DIAGRAM

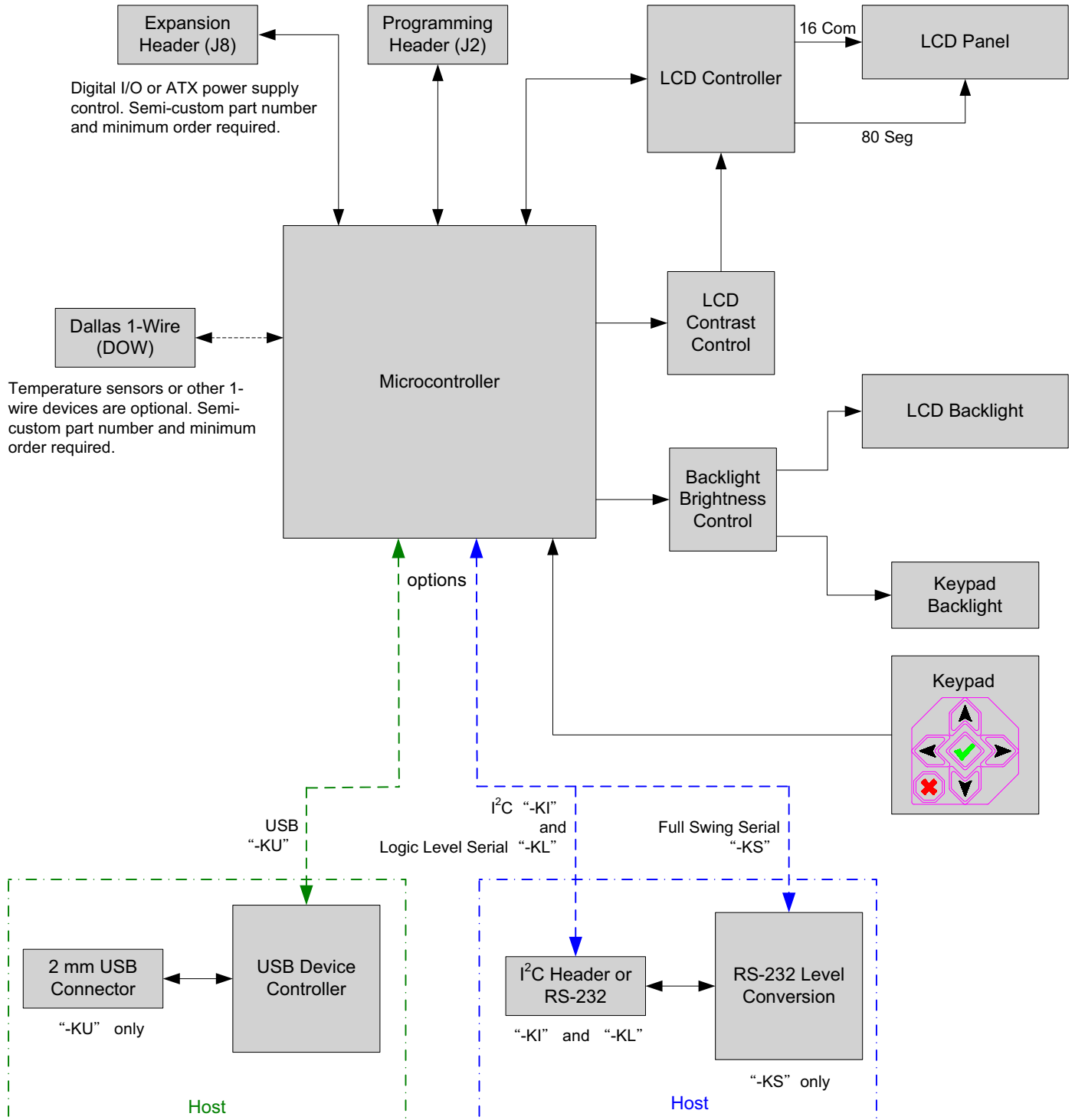

Figure 4. System Block Diagram



SUPPLY VOLTAGES AND CURRENT

SUPPLY VOLTAGE	MINIMUM	MAXIMUM
Power Supply voltage (V_{DD})	+3.3v	+5.5v
Pull-in voltage		3.2v
Drop-out voltage		3.0v

GPIO CURRENT LIMITS	SPECIFICATION
Sink	25 mA
Source	10 mA

CURRENT CONSUMPTION	TYPICAL
+5v for logic (LCD + microcontroller)	< 20mA
+5v for logic (LCD + microcontroller) + YYH backlight	< 120mA



CFA-533 supply current vs supply voltage (typical)

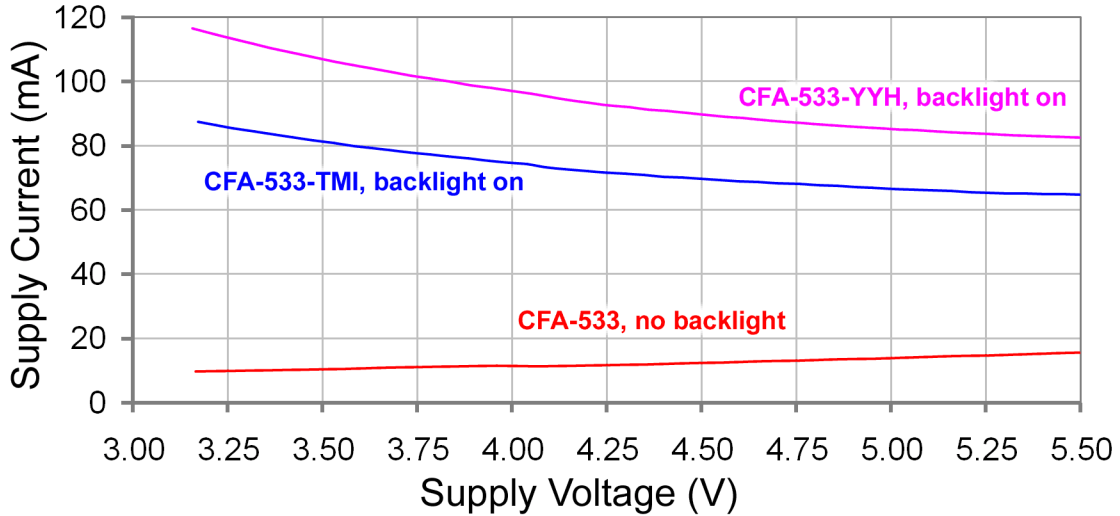

CFA-533-YYH supply current vs backlight setting (typical)

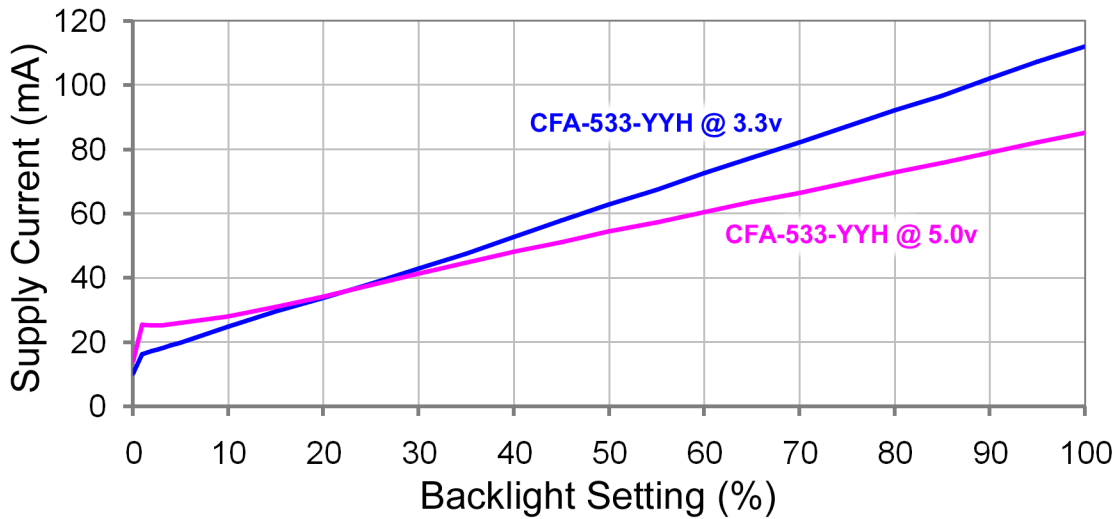

Figure 5. CFA533-YYH-KU Supply Current vs. Supply Voltage



TEMPERATURE RANGE

CRITERIA	SPECIFICATION
Operating Temperature Range	-20°C minimum to +70°C maximum
Storage Temperature Range	-30°C minimum to +80°C maximum

ESD (ELECTRO-STATIC DISCHARGE) SPECIFICATIONS

This circuitry is industry standard CMOS logic and susceptible to ESD damage. Please use industry standard anti-static precautions as you would for any other PCB assembly such as expansion cards or motherboards. Ground your body, work surfaces, and equipment.

ATX POWER SUPPLY POWER AND CONTROL CONNECTIONS

The CFA533-YYH-KU has the ability to control power on/off and reset functions of a standard ATX PC.

NOTE

The GPIO pins used for ATX control must not be configured as user GPIO, and must be configured to their default drive mode in order for the ATX functions to work correctly. These settings are factory default but may be changed by the user. Please see command [34 \(0x22\): Set/Configure GPIO \(Pg. 43\)](#).



The Crystalfontz [WR-PWR-Y14](#) cable simplifies ATX power control connections. When using this cable, please open jumper JP8 in order to ensure correct operation. See [JUMPER LOCATIONS AND FUNCTIONS \(Pg. 47\)](#) for jumper locations and functions.

NOTE

If the Crystalfontz [WR-PWR-Y14](#) cable is ordered at the same time as the module, Crystalfontz will install the WR-PWR-Y14 connector, open jumper JP8, and send the following software configuration commands (unless we are otherwise instructed). Please note that once these changes are made, power must be applied to connector J_PWR, pin +5v, and connector J8 pin +5v for the module to power up:

```
command = 28 // Set ATX Switch Functionality
length = 3
data[0] = 241 // Enable:
                // KEYPAD_POWER_OFF
                // KEYPAD_POWER_ON
                // KEYPAD_RESET
                // LCD_OFF_IF_HOST_IS_OFF
                // AUTO_POLARITY
data[1] = 16 // One half second power pulses
data[2] = 1 // sense ATX host power state on P0.7 (J_PWR, +5v)
command = 4 // Store current state as boot state
length = 0
```

For this functionality, the CFA533-YYH-KU is powered from the PC's V_{SB} signal (V_{SB} is the “stand-by” or “always-on” +5v ATX power supply output).

By default, the pin labeled +5v on the CFA533-YYH-KU's J_PWR connector is electrically connected to the +5v pin on the J8 connector through the normally closed JP8. If you are using the CFA533-YYH-KU to do ATX power control, open jumper JP8, which will disconnect the +5v of connector J_PWR (now used as “POWER-ON SENSE”) from the +5v of connector J8 which now supplies the distinct V_{SB} to power the module.

Since the CFA533-YYH-KU must act differently depending on whether the host's power supply is on or off, you must connect the host's switched +5v to the +5v pin of J_PWR. This pin functions as POWER-ON SENSE. The easiest way to connect the POWER-ON SENSE is to plug the cable from the PC's power supply that would normally be used for 3.5-inch floppy drive to the CFA-533's J_PWR connector.

NOTE

Alternatively, the POWER-ON SENSE can be provided through Pin 6 of J8 (GPIO[1]). This option is only provided to allow backwards compatibility for legacy CFA-633 applications. If you choose this option, R21 must be loaded with a 5K Ω 0805 SMT resistor.

The motherboard's power switch input is connected to Pin 5 of the CFA533-YYH-KU's connector J8 (labeled as GPIO[2]). This pin functions as POWER CONTROL. The POWER CONTROL pin is configured as a high-impedance input until the LCD module wants to turn the host on or off, then it will change momentarily to low impedance output, driving either low or high depending on the setting of POWER_INVERT. (See command [28 \(0x1C\): Set ATX Switch Functionality \(Pg. 39\)](#).)

The motherboard's reset switch input is connected to Pin 4 of the CFA533-YYH-KU connector J8 (labeled as GPIO[3]). This pin functions as RESET. The RESET pin is configured as a high-impedance input until the LCD module wants to reset the host. Then it will change momentarily to low impedance output, driving either low or high depending on the



setting of RESET_INVERT. (See command [28 \(0x1C\): Set ATX Switch Functionality \(Pg. 39\)](#).) This connection is also used for the hardware watchdog.

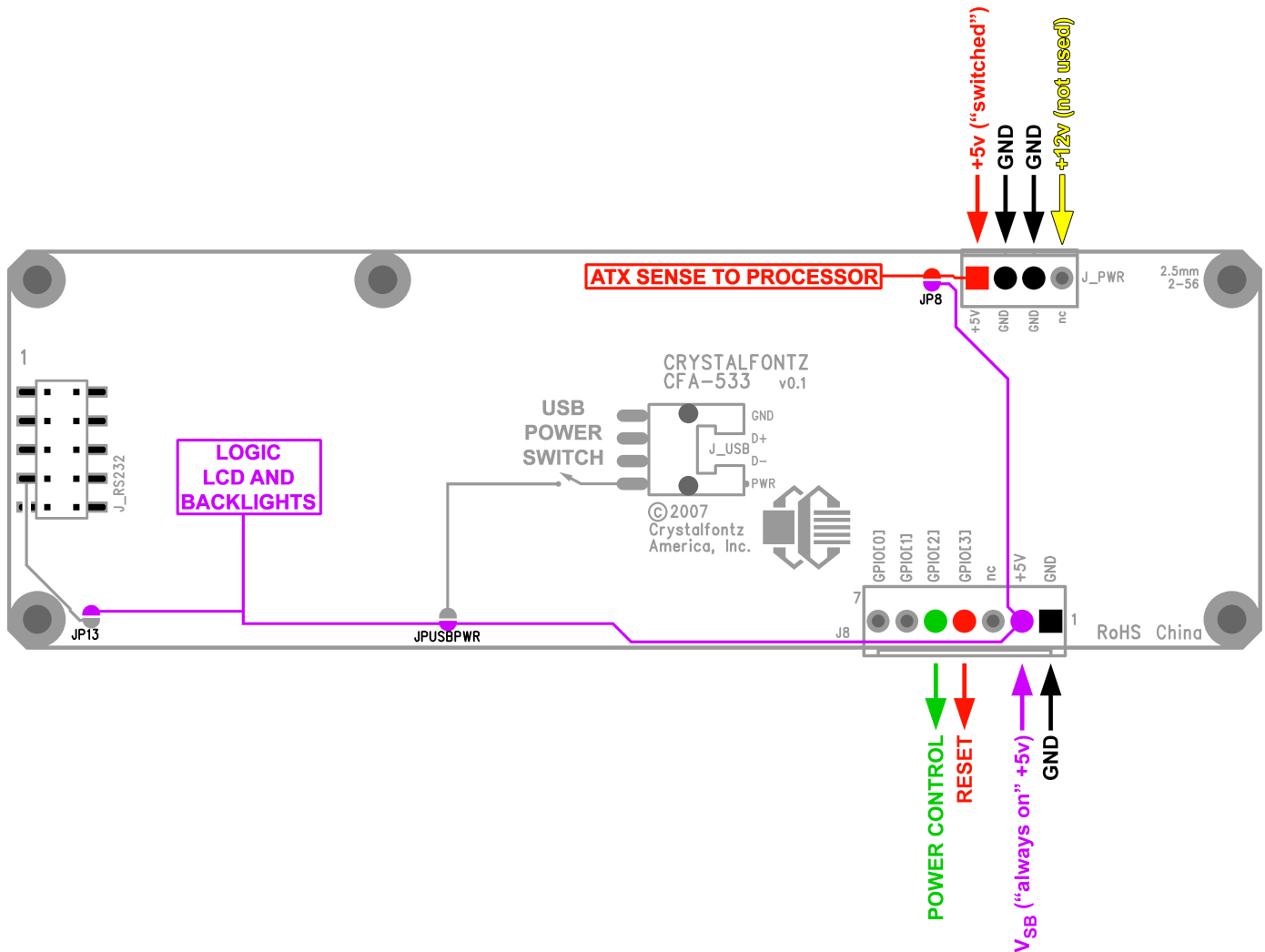

Figure 6. CFA533-YYH-KU ATX Power Supply and Control Connections

Once configured by the host software (see command [28 \(0x1C\): Set ATX Switch Functionality \(Pg. 39\)](#)), the following functions may be individually enabled:

- **System power on.** If POWER-ON SENSE is low (0v), pressing the green check key for 0.25 seconds will turn the unit on by driving POWER CONTROL line for the pulse width set by command 28: Set ATX Power Switch Functionality (1.0 seconds default).
- **System hard power off.** If POWER-ON SENSE is high (V_{DD}) pressing the red "X" key for 4 seconds will turn the system off by driving the POWER CONTROL line. The line will be driven for a minimum of the pulse width set by command 28: Set ATX Power Switch Functionality (1.0 seconds default). If the user continues to press the key, the CFA533-YYH-KU will continue to drive the line for up to an additional 5 seconds.
- **System hard reset.** If POWER-ON SENSE is high (V_{DD}) pressing the green check key for 4 seconds will reset the system by driving the RESET line for 1 second. The CFA533-YYH-KU will reboot itself immediately after resetting the host.



Since the computer and LCD module must look "off" if the computer's power is "off", the CFA533-YYH-KU can be configured to monitor the POWER-ON SENSE line and blank its display any time the POWER-ON SENSE line is low.

Modification by CrystalFontz

CrystalFontz can configure the modules so they will be ready to use in your application without modification by you. We do this by opening JP8, loading the mating connector for the CrystalFontz [WR-PWR-Y14](#) cable in J8, and configuring the ATX firmware functions. For information, please contact technical support (+1-888-206-9720, techinfo@crystalfontz.com). We will provide you with a semi-custom part number. A minimum order quantity may apply.

POWER CONNECTIONS THROUGH USB

For the CFA533-YYH-KU, JUSBPWR will be closed to allow the USB interface to control the power to the module. The USB standard limits the amount of power that a USB peripheral can draw before the host's USB system has allocated power from its power budget to the various USB devices connected to it. For this reason, the CFA533-YYH-KU will stay powered off through the host's boot cycle and will only power up after the host's USB subsystem is fully powered up.

If you want the CFA533-YYH-KU to power up instantly when the host powers up, you can modify the modules or have CrystalFontz modify them for you.

Modification by You

Power via J_PWR

1. Open JPUSBPWR.
2. Close JP8. See [JUMPER LOCATIONS AND FUNCTIONS \(Pg. 47\)](#).
3. Install the appropriate connector ([Tyco Electronics / Amp part number: 172732-4](#), [Mouser part number: 571-1727324](#)) in J_PWR.
4. Connect power by plugging the cable from the PC's power supply that would normally be used for a 3.5-inch floppy drive to the CFA533-YYH-KU's J_PWR connector.

Power via J8

1. Open JPUSBPWR.
2. Provide power through J8, typically through a CrystalFontz [WR-PWR-Y14](#) cable. See [ATX POWER SUPPLY POWER AND CONTROL CONNECTIONS \(Pg. 17\)](#).

Modification by CrystalFontz

We can configure the modules for you by closing JP8. The modules will be ready to use in your application without modification by you. For information, please contact technical support (+1-888-206-9720, techinfo@crystalfontz.com). We will provide you with a semi-custom part number. A minimum order quantity may apply.

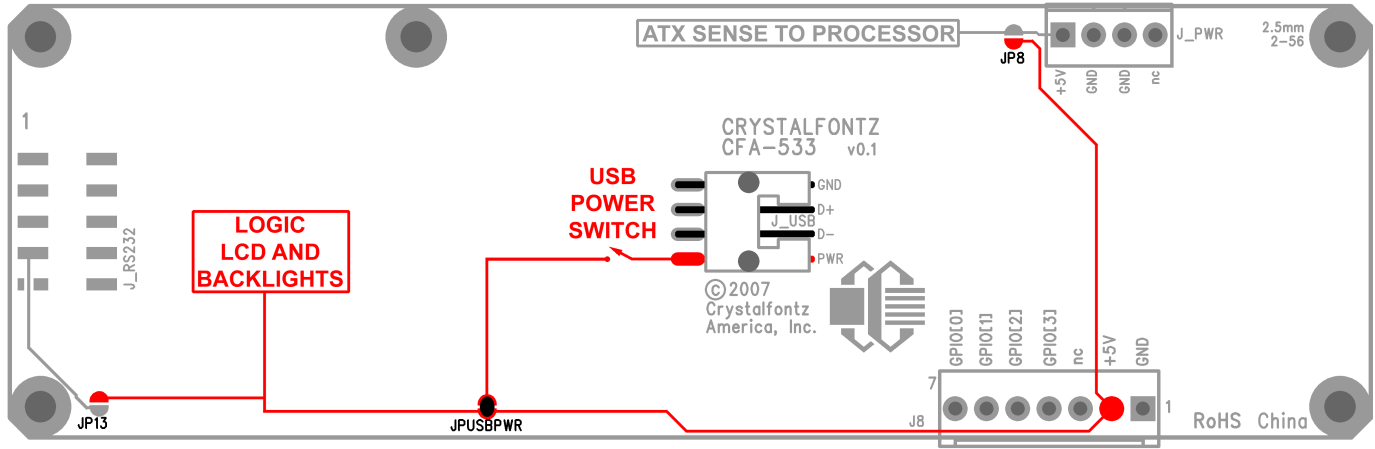

Figure 7. CFA533-YYH-KU Power Connections through USB

GPIO CONNECTIONS

The CFA533-YYH-KU has five General-Purpose Input/Output (GPIO) pins. The GPIO are port pins from the CFA533-YYH-KU's microcontroller brought out to connectors. As an output, a GPIO can be used to turn on an LED, or perhaps drive a relay. As an input, a GPIO can be used to read a switch or a button. Most of the GPIOs have a default function that allows the module to perform some special purpose activity with the pin.

```
GPIO[0] = J8, Pin 7
GPIO[1] = J8, Pin 6 (may be used as ATX Host Power Sense, has R21 in series)
GPIO[2] = J8, Pin 5 (default is ATX Host Power Control)
GPIO[3] = J8, Pin 4 (default is ATX Host Reset Control)
GPIO[4] = J_DOW, Pin 2 (default is DOW I/O--may have 1 kΩ hardware pull-up: R7)
```

GPIO[0], GPIO[2] and GPIO[3] are connected directly from the microcontroller port pin to the connector pin.

GPIO[1] has a series resistor R21. By default, this resistor is not loaded. If you want to use GPIO[0], you load an appropriate value 0805 SMT resistor to suit your application.

GPIO[4] is also used as the DOW I/O pin. Since the DOW requires a pull-up on the I/O pin, R7 may be loaded to pull GPIO[4] to V_{DD} . R7 is not loaded by default.

Please refer to commands [34 \(0x22\): Set/Configure GPIO \(Pg. 43\)](#) and [35 \(0x23\): Read GPIO & Configuration \(Pg. 44\)](#) for additional details concerning the GPIO operation.

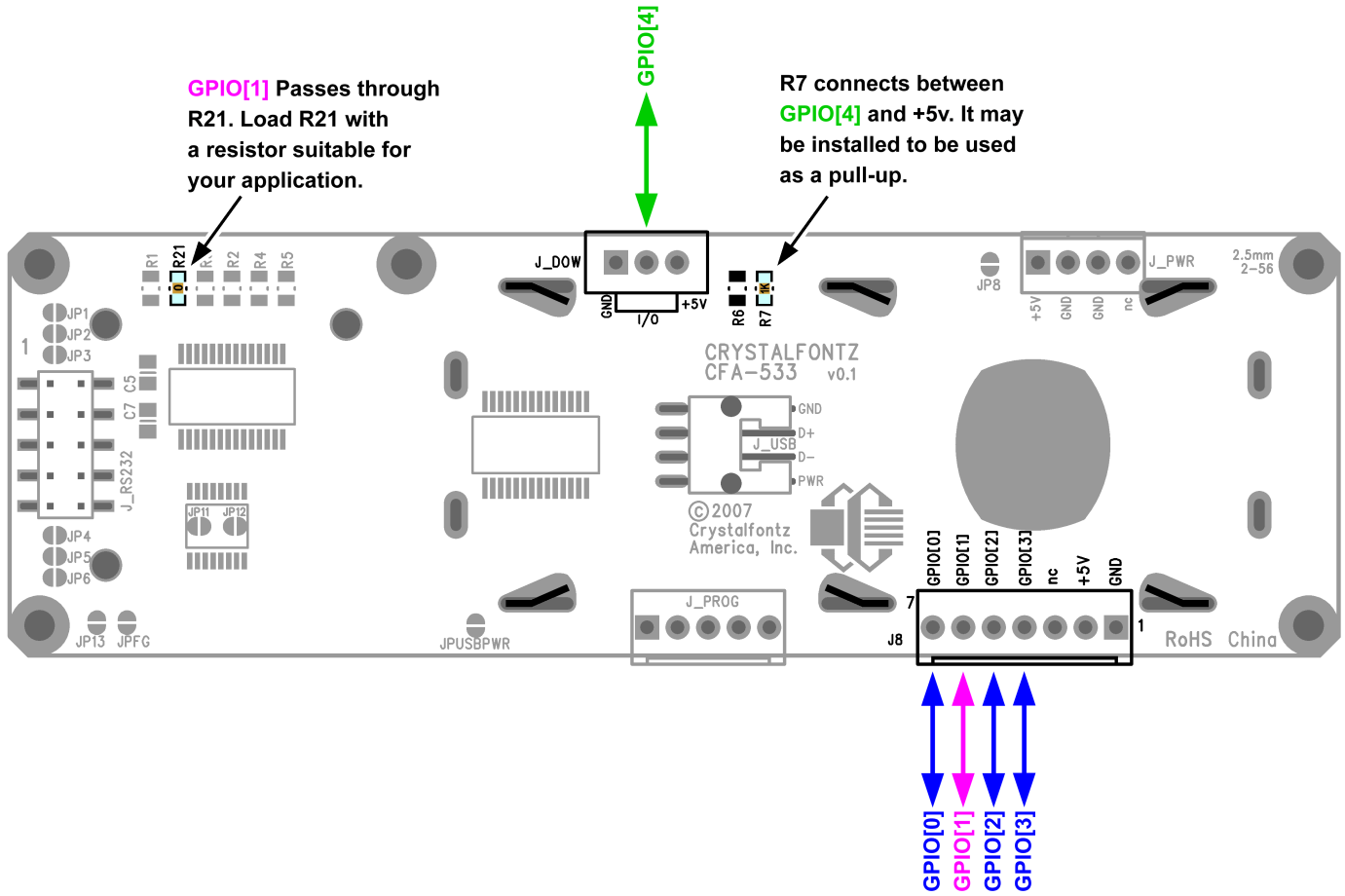

Figure 8. GPIO Connections



DALLAS SEMICONDUCTOR 1-WIRE DEVICE CONNECTIONS

TEMPERATURE SENSORS

The CFA533-YYH-KU supports Dallas Semiconductor 1-Wire (DOW) temperature sensors. By default, the DOW connector and resistors are not loaded. These components can be loaded at the factory by request.

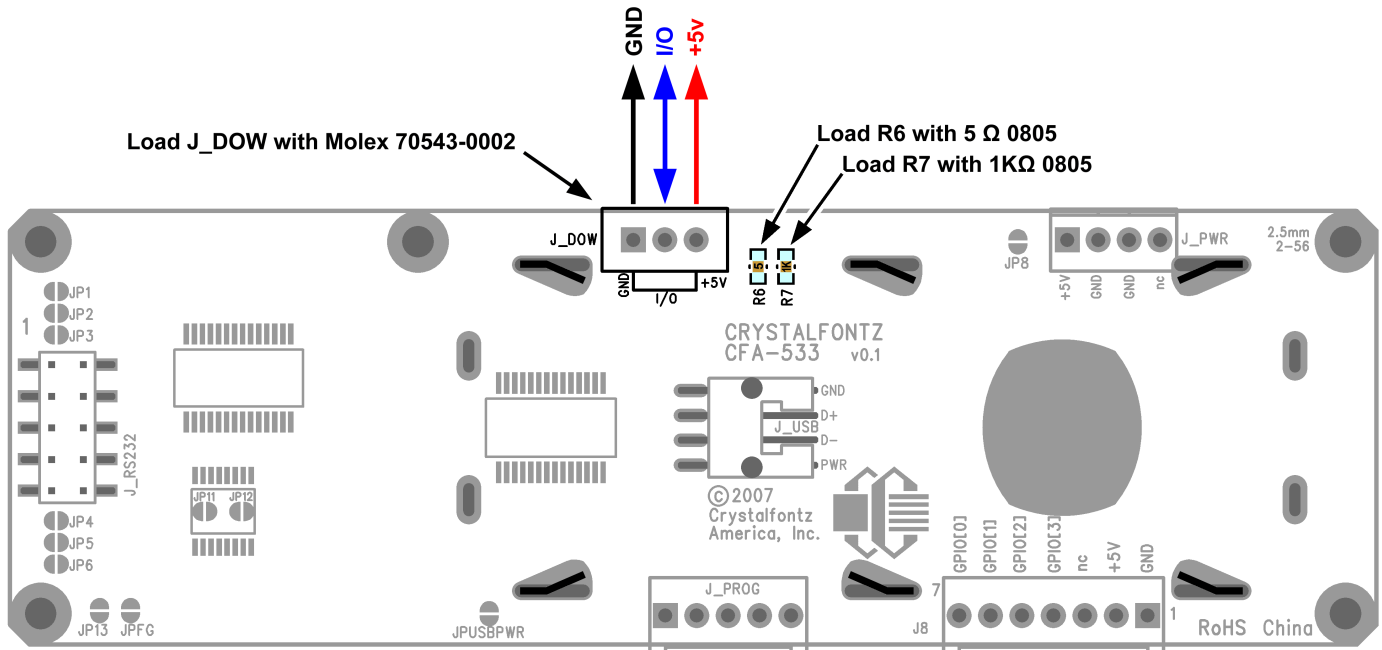

Figure 9. CFA533-YYH-KU Connection for Dallas Semiconductor 1-Wire (DOW) Devices

Any combination of up to 32 [DS1822](#) Econo 1-Wire Digital Thermometer (2°C absolute accuracy) or [DS18B20](#) High Precision 1-Wire Digital Thermometer (0.5°C absolute accuracy) temperature sensors or other DOW compatible devices are directly supported. (See [Figure 9. on Pg. 23.](#))

The Crystalfontz [WR-DOW-Y17](#) has a DS18B20 attached to a “daisy chain” cable. If a WR-DOW-Y17 is ordered at the same time as a CFA533-YYH-KU, Crystalfontz can load the WR-DOW-Y17’s mating connector into the CFA533-YYH-KU’s “DOW” position. For reference, the mating connector for the WR-DOW-Y17 is [Molex 70543-0002](#) available from Digi-Key or other parts suppliers.

The temperature sensor can be configured to be automatically read and displayed on the CFA533-YYH-KU’s LCD in °C or °F (see command [21 \(0x15\): Set Up Live Temperature Display \(Pg. 36\)](#)). Independently, any temperature sensor can be configured to report to the host (see [19 \(0x13\): Set Up Temperature Reporting \(Pg. 34\)](#)). The sensors configured to be reported are updated once each second.

OTHER 1-WIRE DEVICES

Other [Dallas Semiconductor 1-Wire devices](#) may be connected to the 1-Wire bus, with the CFA533-YYH-KU acting as a bridge between USB and the 1-Wire bus (see command [21 \(0x15\): Set Up Live Temperature Display \(Pg. 36\)](#)). The total number of 1-Wire devices supported is 32, including directly supported temperature sensors and any other user-provided 1-Wire devices. (See CFA533-YYH-KU’s DOW connection location in [Figure 9. on Pg. 23.](#)) The module can



send up to 15 bytes and receive up to 14 bytes. This will be sufficient for many devices but some devices require larger transactions and cannot be fully used with the module.

The CFA533-YYH-KU has a provision to load a 1 KΩ hardware pull-up on the DOW connector's I/O line at R7.

Connect the 1-Wire sensors as detailed in the sensor's data sheet.

HOST COMMUNICATIONS

NOTE

Because there is no difference in communications and commands for I²C variants (part numbers ending in “-KI”), serial variants (part numbers ending in “-KL” or “-KS”) and USB variants (part numbers ending in “-KU”) of the CFA-533, the Host Communications section of this Data Sheet uses the shorter term “CFA-533” instead of CFA533-YYH-KU”.

The CFA-533 series (includes CFA533-YYH-KU) communicates with its host using an RS-232 interface. The port settings are 19200 baud, 8 data bits, no parity, 1 stop bit by factory default. The speed can be set to 115200 baud under software control (see command [33 \(0x21\): Set Baud Rate \(Pg. 42\)](#)).

PACKET STRUCTURE

All communication between the CFA-533 and the host takes place in the form of a simple and robust CRC checked packet. The packet format allows for very reliable communications between the CFA-533 and the host without the traditional problems that occur in a stream-based serial communication (such as having to send data in inefficient ASCII format, to “escape” certain “control characters”, or losing sync if a character is corrupted, missing, or inserted).

All packets have the following structure:

<type><data_length><data><CRC>

type is one byte, and identifies the type and function of the packet:

```

TTcc cccc
||| ||| |---Command, response, error or report code 0-63
|| |-----Type:
       00 = normal command from host to CFA-533
       01 = normal response from CFA-533 to host
       10 = normal report from CFA-533 to host (not indirect response to a command
           from the host)
       11 = error response from CFA-533 to host (a packet with valid structure but
           illegal content was received by the CFA-533)

```

data_length specifies the number of bytes that will follow in the data field. The valid range of data_length is 0 to 18.

data is the payload of the packet. Each type of packet will have a specified data_length and format for data as well as algorithms for decoding data detailed below.

crc is a standard 16-bit CRC of all the bytes in the packet except the CRC itself. The CRC is sent LSB first. At the port, the CRC immediately follows the last used element of data []. See [APPENDIX B: CALCULATING THE CRC \(Pg. 56\)](#) for several examples of how to calculate the CRC in different programming languages.



The following concept may be useful for understanding the packet structure.

```
typedef struct
{
    unsigned char
        command;
    unsigned char
        data_length;
    unsigned char
        data[data_length];
    unsigned short
        CRC;
}COMMAND_PACKET;
```

Crystalfontz supplies a demonstration and test program [633_WinTest](#) along with its C source code. Both will work with the CFA-533 modules. Included in the [633_WinTest](#) source is a CRC algorithm and an algorithm that detects packets. The algorithm will automatically re-synchronize to the next valid packet in the event of any communications errors. Please follow the algorithm in the sample code closely in order to realize the benefits of using the packet communications.

ABOUT HANDSHAKING

The nature of CFA-533's packets makes it unnecessary to implement traditional hardware or software handshaking.

The host should wait for a corresponding acknowledge packet from the CFA-533 before sending the next command packet. The CFA-533 will respond to all packets within 250 mS. The host software should stop waiting and retry the packet if the CFA-533 fails to respond within 250 mS. The host software should report an error if a packet is not acknowledged after several retries. This situation indicates a hardware problem—for example, a disconnected cable.

Please note that some operating systems may introduce delays between when the data arrives at the physical port from the CFA-533 until it is available to the user program. In this case, the host program may have to increase its timeout window to account for the additional overhead of the operating system.

The CFA-533 can be configured to send several types of report packets along with regular acknowledge packets. The host should be able to buffer several incoming packets and must guarantee that it can process and remove packets from its input buffer faster than the packets can arrive given the baud rate and the reporting configuration of the CFA-533. For any modern PC using reasonably efficient software, this requirement will not pose a challenge.

The report packets are sent asynchronously with respect to the command packets received from the host. The host should not assume that the first packet received after it sends a command is the acknowledge packet for that command. The host should inspect the `type` field of incoming packets and process them accordingly.

REPORT CODES

The CFA-533 can be configured to report two items. The CFA-533 sends reports automatically when the data becomes available. Reports are not sent in response to a particular packet received from the host. The two report types are:

0x80: Key Activity

If a key is pressed or released, the CFA-533 sends a Key Activity report packet to the host. Key event reporting may be individually enabled or disabled by command [23 \(0x17\): Configure Key Reporting \(Pg. 37\)](#).



```
type: 0x80
data_length: 1
data[0] is the type of keyboard activity:
KEY_UP_PRESS          1
KEY_DOWN_PRESS       2
KEY_LEFT_PRESS       3
KEY_RIGHT_PRESS      4
KEY_ENTER_PRESS      5
KEY_EXIT_PRESS       6
KEY_UP_RELEASE       7
KEY_DOWN_RELEASE     8
KEY_LEFT_RELEASE     9
KEY_RIGHT_RELEASE   10
KEY_ENTER_RELEASE   11
KEY_EXIT_RELEASE    12
```

These codes are identical to the codes returned by the [CFA-635](#) and [CFA-633](#) Please note that the [CFA-631](#) will return codes 13 through 20. (See the [CFA-631](#) Data Sheet on our website for more details).

0x81: (reserved)

0x82: Temperature Sensor Report

If any of the up to 32 temperature sensors is configured to report to the host, the CFA-533 will send Temperature Sensor Reports for each selected sensor every second. See the command [19 \(0x13\): Set Up Temperature Reporting \(Pg. 34\)](#) below.

```
type: 0x82
data_length: 4
data[0] is the index of the temperature sensor being reported:
    0 = temperature sensor 1
    1 = temperature sensor 2
    . . .
    31 = temperature sensor 32
data[1] is the LSB of Temperature_Sensor_Counts
data[2] is the MSB of Temperature_Sensor_Counts
data[3] is DOW_crc_status
```

The following C function will decode the Temperature Sensor Report packet into °C and °F:

```
void OnReceivedTempReport(COMMAND_PACKET *packet, char *output)
{
    //First check the DOW CRC return code from the CFA-533
    if(packet->data[3]==0)
        strcpy(output, "BAD CRC");
    else
    {
        double
            degc;
        degc=(*(short *)&(packet->data[1]))/16.0;

        double
            degf;
        degf=(degc*9.0)/5.0+32.0;

        sprintf(output, "%9.4f°C =%9.4f°F",
                degc,
                degf);
    }
}
```



COMMAND CODES

Below is a list of valid commands for the CFA-533. Each command packet is answered by either a response packet or an error packet. The low 6 bits of the `type` field of the response or error packet is the same as the low 6 bits of the `type` field of the command packet being acknowledged.

0 (0x00): Ping Command

The CFA-533 will return the Ping Command to the host.

```
type: 0x00 = 010  
valid data_length is 0 to 16  
data[0-(data_length-1)] can be filled with any arbitrary data
```

The return packet is identical to the packet sent, except the type will be 0x40 (normal response, Ping Command):

```
type: 0x40 | 0x00 = 0x40 = 6410  
data_length: (identical to received packet)  
data[0-(data_length-1)] = (identical to received packet)
```

1 (0x01): Get Hardware & Firmware Version

The CFA-533 will return the hardware and firmware version information to the host.

```
type: 0x01 = 110  
valid data_length is 0
```

The return packet will be:

```
type: 0x40 | 0x01 = 0x41 = 6510  
data_length: 16  
data[] = "CFA-533:hX.X,yY.Y"
```

hX.X is the hardware revision, "1.5" for example
yY.Y is the firmware version, "v1.9" for example

2 (0x02): Write User Flash Area

The CFA-533 reserves 16 bytes of nonvolatile memory for arbitrary use by the host. This memory can be used to store data such as a serial number, IP address, gateway address, netmask, or any other data required. All 16 bytes must be supplied.

```
type: 0x02 = 210  
valid data_length is 16  
data[] = 16 bytes of arbitrary user data to be stored in the CFA-533's non-volatile memory
```

The return packet will be:

```
type: 0x40 | 0x02 = 0x42 = 6610  
data_length: 0
```

3 (0x03): Read User Flash Area

This command will read the User Flash Area and return the data to the host.

```
type: 0x03 = 310  
valid data_length is 0
```



The return packet will be:

```
type: 0x40 | 0x03 = 0x43 = 6710  
data_length: 16  
data[] = 16 bytes user data recalled from the CFA-533's non-volatile memory
```

4 (0x04): Store Current State as Boot State

The CFA-533 loads its power-up configuration from nonvolatile memory when power is applied. The CFA-533 is configured at the factory to display a “welcome screen” when power is applied. This command can be used to customize the welcome screen, as well as the following items:

- Characters shown on LCD, which are affected by:
 - command [6 \(0x06\): Clear LCD Screen \(Pg. 29\)](#).
 - command [7 \(0x07\): Set LCD Contents, Line 1 \(Pg. 29\)](#).
 - command [8 \(0x08\): Set LCD Contents, Line 2 \(Pg. 30\)](#).
 - command [31 \(0x1F\): Send Data to LCD \(Pg. 42\)](#).
- Special character font definitions (command [9 \(0x09\): Set LCD Special Character Data \(Pg. 30\)](#)).
- Cursor position (command [11 \(0x0B\): Set LCD Cursor Position \(Pg. 31\)](#)).
- Cursor style (command [12 \(0x0C\): Set LCD Cursor Style \(Pg. 31\)](#)).
- Contrast setting (command [13 \(0x0D\): Set LCD Contrast \(Pg. 31\)](#)).
- LCD backlight setting (command [14 \(0x0E\): Set LCD & Keypad Backlight](#)).
- Keypad backlight setting (command [14 \(0x0E\): Set LCD & Keypad Backlight](#)).
- Settings of any live displays (command [21 \(0x15\): Set Up Live Temperature Display](#)).
- Key press and release masks (command [23 \(0x17\): Configure Key Reporting \(Pg. 37\)](#)).
- ATX function enable and pulse length settings (command [28 \(0x1C\): Set ATX Switch Functionality \(Pg. 39\)](#)).
- Baud rate (command [33 \(0x21\): Set Baud Rate \(Pg. 42\)](#)).
- GPIO settings (command [34 \(0x22\): Set/Configure GPIO \(Pg. 43\)](#)).

You cannot store the temperature reporting (although the live display of temperatures can be saved). You cannot store the host watchdog. The host software should enable this item once the system is initialized and it is ready to receive the data.

```
type: 0x04 = 410  
valid data_length is 0
```

The return packet will be:

```
type: 0x40 | 0x04 = 0x44 = 6810  
data_length: 0
```

5 (0x05): Reboot CFA-533, Reset Host, or Power Off Host

This command instructs the CFA-533 to simulate a power-on restart of itself, reset the host, or turn the host's power off. The ability to reset the host may be useful to allow certain host operating system configuration changes to complete. The ability to turn the host's power off under software control may be useful in systems that do not have ACPI compatible BIOS.

NOTE

The GPIO pins used for ATX control must not be configured as user GPIO, and must be configured to their default drive mode in order for the ATX functions to work correctly. These settings are factory default, but may be changed by the user. Please see command [34 \(0x22\): Set/Configure GPIO \(Pg. 43\)](#).



Rebooting the CFA-533 may be useful when testing the boot configuration. It may also be useful to re-enumerate the devices on the 1-Wire bus. To reboot the CFA-533, send the following packet:

```
type: 0x05 = 510
valid data_length is 3
data[0] = 8
data[1] = 18
data[2] = 99
```

To reset the host, assuming the host's reset line is connected to GPIO[3] as described in command [28 \(0x1C\): Set ATX Switch Functionality \(Pg. 39\)](#), send the following packet:

```
type: 0x05 = 510
valid data_length is 3
data[0] = 12
data[1] = 28
data[2] = 97
```

To turn the host's power off, assuming the host's power control line is connected to GPIO[2] as described in command [28 \(0x1C\): Set ATX Switch Functionality \(Pg. 39\)](#), send the following packet:

```
type: 0x05 = 510
valid data_length is 3
data[0] = 3
data[1] = 11
data[2] = 95
```

In any of the above cases, the return packet will be:

```
type: 0x40 | 0x05 = 0x45 = 6910
data_length: 0
```

6 (0x06): Clear LCD Screen

Sets the contents of the LCD screen DDRAM to ' ' = 0x20 = 32₁₀ and moves the cursor to the left-most column of the top line.

```
type: 0x06 = 610
valid data_length is 0
```

The return packet will be:

```
type: 0x40 | 0x06 = 0x46 = 7010
data_length: 0
```

Clear LCD Screen is one of the items stored by the command [4 \(0x04\): Store Current State as Boot State \(Pg. 28\)](#).

7 (0x07): Set LCD Contents, Line 1

Sets the center 16 characters displayed for the top line of LCD screen.

NOTE

Please use this command only if you need backwards compatibility with older CFA-633 units. For new applications, please use the more flexible command [31 \(0x1F\): Send Data to LCD \(Pg. 42\)](#) which is also supported by the CFA-631 and CFA-635.

```
type: 0x7 = 710
valid data_length is 16
data[] = top line's display content (must supply 16 bytes)
```



The return packet will be:

```
type: 0x40 | 0x07 = 0x47 = 7110  
data_length: 0
```

Set LCD Contents, Line 1 is one of the items stored by the command [4 \(0x04\): Store Current State as Boot State \(Pg. 28\)](#).

8 (0x08): Set LCD Contents, Line 2

Sets the center 16 characters displayed for the bottom line of LCD screen.

NOTE

Please use this command only if you need backwards compatibility with older CFA-633 units. For new applications, please use the more flexible command [31 \(0x1F\): Send Data to LCD \(Pg. 42\)](#) which is also supported by the CFA-631 and CFA-635.

```
type: 0x8 = 810  
valid data_length is 16  
data[] = top line's display content (must supply 16 bytes)
```

The return packet will be:

```
type: 0x40 | 0x08 = 0x48 = 7210  
data_length: 0
```

Set LCD Contents, Line 2 is one of the items stored by the command [4 \(0x04\): Store Current State as Boot State \(Pg. 28\)](#).

9 (0x09): Set LCD Special Character Data

Sets the font definition for one of the special characters (CGRAM).

```
type: 0x09 = 910  
valid data_length is 9  
data[0] = index of special character that you would like to modify, 0-7 are valid  
data[1-8] = bitmap of the new font for this character
```

data[1-8] are the bitmap information for this character. Any value is valid between 0 and 63, the msb is at the left of the character cell of the row, and the lsb is at the right of the character cell. data[1] is at the top of the cell, data[8] is at the bottom of the cell.

The return packet will be:

```
type: 0x40 | 0x09 = 0x49 = 7310  
data_length: 0
```

Set LCD Special Character Data is one of the items stored by the command [4 \(0x04\): Store Current State as Boot State \(Pg. 28\)](#).

10 (0x0A): Read 8 Bytes of LCD Memory

This command will return the contents of the LCD's DDRAM or CGRAM. This command is intended for debugging.



```
type: 0x0A = 1010
valid data_length is 1
data[0] = address code of desired data
```

data[0] is the address code native to the LCD controller:

```
0x40 (\064) to 0x7F (\127) for CGRAM
0x80 (\128) to 0x93 (\147) for DDRAM, line 1
0xC0 (\192) to 0xD3 (\211) for DDRAM, line 2
```

The return packet will be:

```
type: 0x40 | 0x0A = 0x4A = 7410
data_length: 9
```

data[0] of the return packet will be the address code.

data[1-8] of the return packet will be the data read from the LCD controller's memory.

11 (0x0B): Set LCD Cursor Position

This command allows the cursor to be placed at the desired location on the CFA-533's LCD screen. If you want the cursor to be visible, you may also need to send a command [12 \(0x0C\): Set LCD Cursor Style \(Pg. 31\)](#).

```
type: 0x0B = 1110
valid data_length is 2
data[0] = column (0-19 valid)
data[1] = row (0-3 valid)
```

The return packet will be:

```
type: 0x40 | 0x0B = 0x4B = 7510
data_length: 0
```

Set LCD Cursor Position is one of the items stored by the command [4 \(0x04\): Store Current State as Boot State \(Pg. 28\)](#).

12 (0x0C): Set LCD Cursor Style

This command allows you to select among four hardware generated cursor options.

```
type: 0x0C = 1210
valid data_length is 1
data[0]: cursor style (0-3 valid)
0 = no cursor
1 = blinking block cursor
2 = underscore cursor
3 = blinking block plus underscore
```

The return packet will be:

```
type: 0x40 | 0x0C = 0x4C = 7610
data_length: 0
```

Set LCD Cursor Style is one of the items stored by the command [4 \(0x04\): Store Current State as Boot State \(Pg. 28\)](#).

13 (0x0D): Set LCD Contrast

This command sets the contrast or vertical viewing angle of the display. (Initiated by the host, responded to by the CFA-533.)



- **CFA-633** Compatible

If only one byte of data is supplied, then it is the “**CFA-633** Compatible” version of the command. Requires 1 byte (0-200) are valid, but only (0-50) are useful for this LCD.

```
type: 0x0D = 1310
valid data_length is 1
data[0]: contrast setting (0-50 valid)
    0 = light
    16 = about right
    29 = dark
    30-50 = very dark
```

The return packet will be:

```
type: 0x40 | 0x0D = 0x4D = 7710
data_length: 0
```

- **CFA-533** Enhanced

If two bytes of data are supplied, then the command takes advantage of the CFA-533s native enhanced contrast resolution. Requires 2 bytes.

- The first byte data[0] is ignored, any value from 0 to 255 is accepted.
- The second byte data[1] controls the CFA-533 contrast with better resolution.

```
type: 0x0D = 1310
valid data_length is 1
data[0]: required but ignored
data[1]: contrast setting (0-200 valid)
    0-99 = lighter
    100 = no correction
    101-200 = darker
```

The return packet will be:

```
type: 0x40 | 0x0D = 0x4D = 7710
data_length: 0
```

Set LCD Contrast is one of the items stored by the command [4 \(0x04\): Store Current State as Boot State \(Pg. 28\)](#).

14 (0x0E): Set LCD & Keypad Backlight

This command sets the brightness of the LCD and keypad backlights. (Initiated by the host, responded to by the CFA-533.)

- If one byte is supplied, both the keypad and LCD backlights are set to that brightness (**CFA-633** compatible).

```
type: 0x0E = 1410
valid data_length is 1
data[0]: keypad and LCD backlight power setting (0-100 valid)
    0 = off
    1-100 = variable brightness
```

The return packet will be:

```
type: 0x40 | 0x0E = 0x4E = 7810
data_length: 0
```

- If two bytes are supplied, the LCD is set to the brightness of the first byte, the keypad is set to the brightness of the second byte.

```
type: 0x0E = 1410
valid data_length is 2
data[0]: LCD backlight power setting (0-100 valid)
```



0 = off
1-100 = variable brightness

data[1]: keypad backlight power setting (0-100 valid)
0 = off
1-100 = variable brightness

The return packet will be:

type: 0x40 | 0x0E = 0x4E = 78₁₀
data_length: 0

Set LCD & Keypad Backlight is one of the items stored by the command [4 \(0x04\): Store Current State as Boot State \(Pg. 28\)](#).

15-17 (0x0F-0x11): (reserved)

18 (0x12): Read DOW Device Information

When power is applied to the CFA-533, it detects any devices connected to the Dallas Semiconductor 1-Wire (DOW) bus and stores the device's information. This command will allow the host to read the device's information.

The first byte returned is the "family code" of the Dallas 1-Wire / iButton device. There is a list of the possible Dallas 1-Wire / iButton device family codes available in [App Note 155: 1-Wire Software Resource Guide](#) on the Maxim/Dallas website.

NOTE ON COMMAND 18: READ DOW DEVICE INFORMATION

The GPIO pin used for DOW must not be configured as user GPIO. It must be configured to its default drive mode in order for the DOW functions to work correctly.

These settings are factory default but may be changed by the user. Please see command [34 \(0x22\): Set/Configure GPIO \(Pg. 43\)](#).

In order for the DOW subsystem to be enabled and operate correctly, user GPIO[4] must be configured as:

```
DDD = "111: 1=Hi-Z, 0=Slow, Strong Drive Down".  
F = "0: Port unused for user GPIO."
```

This state is the factory default, but it can be changed and saved by the user. To ensure that GPIO[4] is set correctly and the DOW operation is enabled, send the following command:

```
command = 34  
length = 3  
data[0] = 4  
data[1] = 100  
data[2] = 7
```

This setting must be saved as the boot state, so when the CFA-533 reboots it will detect the DOW devices.

```
type: 0x12 = 1810  
valid data_length is 1  
data[0] = device index (0-31 valid)
```



The return packet will be:

```

type: 0x40 | 0x12 = 0x52 = 8210
data_length: 9
data[0] = device index (0-31 valid)
data[1-8] = ROM ID of the device
  
```

If data[1] is 0x22 ([DS1822](#) Econo 1-Wire Digital Thermometer temperature sensor) or 0x28 ([DS18B20](#) High Precision 1-Wire Digital Thermometer temperature sensor), then that device can be set up to automatically convert and report the temperature every second. See the command [19 \(0x13\): Set Up Temperature Reporting \(Pg. 34\)](#).

19 (0x13): Set Up Temperature Reporting

This command will configure the CFA-533 to report the temperature information to the host every second.

```

type: 0x13 = 1910
valid data_length is 4
data[0-3] = 32-bit bitmask indicating which temperature sensors are enabled to report
           (0-255 valid in each location)
  
```

```

data[0]
08 07 06 05 04 03 02 01 Enable Reporting of sensor with
| | | | | | | | device index of:
| | | | | | | | -- 0: 1 = enable, 0 = disable
| | | | | | | | ---- 1: 1 = enable, 0 = disable
| | | | | | | | ----- 2: 1 = enable, 0 = disable
| | | | | | | | ----- 3: 1 = enable, 0 = disable
| | | | | | | | ----- 4: 1 = enable, 0 = disable
| | | | | | | | ----- 5: 1 = enable, 0 = disable
| | | | | | | | ----- 6: 1 = enable, 0 = disable
| | | | | | | | ----- 7: 1 = enable, 0 = disable
  
```

```

data[1]
16 15 14 13 12 11 10 09 Enable Reporting of sensor with
| | | | | | | | device index of:
| | | | | | | | -- 8: 1 = enable, 0 = disable
| | | | | | | | ---- 9: 1 = enable, 0 = disable
| | | | | | | | ----- 10: 1 = enable, 0 = disable
| | | | | | | | ----- 11: 1 = enable, 0 = disable
| | | | | | | | ----- 12: 1 = enable, 0 = disable
| | | | | | | | ----- 13: 1 = enable, 0 = disable
| | | | | | | | ----- 14: 1 = enable, 0 = disable
| | | | | | | | ----- 15: 1 = enable, 0 = disable
  
```

```

data[2]
24 23 22 21 20 19 18 17 Enable Reporting of sensor with
| | | | | | | | device index of:
| | | | | | | | -- 16: 1 = enable, 0 = disable
| | | | | | | | ---- 17: 1 = enable, 0 = disable
| | | | | | | | ----- 18: 1 = enable, 0 = disable
| | | | | | | | ----- 19: 1 = enable, 0 = disable
| | | | | | | | ----- 20: 1 = enable, 0 = disable
| | | | | | | | ----- 21: 1 = enable, 0 = disable
| | | | | | | | ----- 22: 1 = enable, 0 = disable
| | | | | | | | ----- 23: 1 = enable, 0 = disable
  
```

(Continues on the next page.)

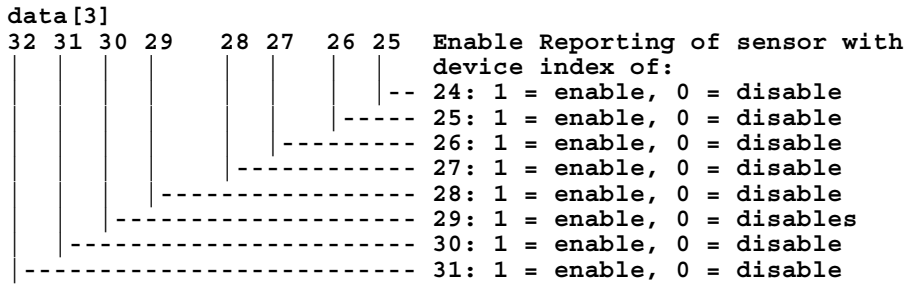

Any sensor enabled must have been detected as a 0x22 (DS1822 temperature sensor) or 0x28 (DS18B20 temperature sensor) during DOW enumeration. This can be verified by using the command [18 \(0x12\): Read DOW Device Information \(Pg. 33\)](#).

The return packet will be:

```

type: 0x40 | 0x13 = 0x53 = 8310
data_length: 0
  
```

20 (0x14): Arbitrary DOW Transaction

The CFA-533 can function as a RS-232 to Dallas 1-Wire bridge. The CFA-533 can send up to 15 bytes and receive up to 14 bytes. This will be sufficient for many devices, but some devices require larger transactions and cannot be fully used with the CFA-533.

This command allows you to specify arbitrary transactions on the 1-Wire bus. 1-Wire commands follow this basic layout:

```

<bus reset           //Required
<address_phase>     //Must be "Match ROM" or "Skip ROM"
<write_phase>       //optional, but at least one of write_phase or read_phase must be sent
<read_phase>        //optional, but at least one of write_phase or read_phase must be sent
  
```

Please see [APPENDIX C: CONNECTING A DS2450 1-WIRE QUAD A/D CONVERTER \(Pg. 65\)](#) for an example of using this command.

```

type: 0x14 = 2010
valid data_length is 2 to 16
  data[0] = device_index (0-32 valid)
  data[1] = number_of_bytes_to_read (0-14 valid)
data[2-15] = data_to_be_written[data_length-2]
  
```

If `device_index` is 32, then no address phase will be executed. If `device_index` is in the range of 0 to 31, and a 1-Wire device was detected for that `device_index` at power on, then the write cycle will be prefixed with a "Match ROM" command and the address information for that device.

If `data_length` is two, then no specific write phase will be executed (although address information may be written independently of `data_length` depending on the value of `device_index`).

If `data_length` is greater than two, then `data_length-2` bytes of `data_to_be_written` will be written to the 1-Wire bus immediately after the address phase.

If `number_of_bytes_to_read` is zero, then no read phase will be executed. If `number_of_bytes_to_read` is not zero then `number_of_bytes_to_read` will be read from the bus and loaded into the response packet.



The return packet will be:

```
type: 0x40 | 0x14 = 0x54 = 8410
data_length: 2 to 16
data[0] = device index (0-31 valid)
data[data_length-2] = Data read from the 1-Wire bus. This is the same as
                    number_of_bytes_to_read from the command.
data[data_length-1] = 1-Wire CRC
```

21 (0x15): Set Up Live Temperature Display

You can configure the CFA-533 to automatically update a portion of the LCD with a live temperature reading. Once the display is configured using this command, the CFA-533 will continue to display the live reading on the LCD without host intervention. The Set Up Live Temperature Display is one of the items stored by command [4 \(0x04\): Store Current State as Boot State \(Pg. 28\)](#), so you can configure the CFA-533 to immediately display system temperatures as soon as power is applied.

The live display is based on a concept of display slots. There are 4 slots, and each of the 4 slots may be enabled or disabled independently.

Any slot may be requested to display any data that is available. For instance, slot 0 could display temperature sensor 3 in °C, while slot 1 could simultaneously display temperature sensor 3 in °F.

Any slot may be positioned at any location on the LCD, as long as all the digits of that slot fall fully within the display area. It is legal to have the display area of one slot overlap the display area of another slot, but senseless. This situation should be avoided in order to have meaningful information displayed.

```
type: 0x15 = 2110
valid data_length is 7 or 2 (for turning a slot off)
data[0]: display slot (0-7)
data[1]: type of item to display in this slot
        0 = nothing (data_length then must be 2)
        1 = (invalid)
        2 = temperature (data_length then must be 7)
data[2]: index of the sensor to display in this slot:
        0-31 are valid for temperatures (and the temperature device must be attached)
data[3]: number of digits
        for a temperature: 3 digits (-XX or XXX)
        for a temperature: 5 digits (-XX.X or XXX.X)
data[4]: display column
        0-13 valid for a 3-digit temperature
        0-11 valid for a 5-digit temperature
data[5]: display row (0-1 valid)
data[6]: temperature units (0 = deg C, 1 = deg F)
```

If a 1-Wire CRC error is detected, the temperature will be displayed as "ERR" or "ERROR".

The return packet will be:

```
type: 0x40 | 15 = 0x55 = 8510
data_length: 0
```

22 (0x16): Send Command Directly to the LCD Controller

The Neotek [NT7070BDS](#) controller on the CFA-533 is S6A0073 compatible. Generally you won't need low-level access to the LCD controller but some arcane functions of the S6A0073 are not exposed by the CFA-533's command set. This command allows you to access the CFA-533's LCD controller directly. Note: It is possible to corrupt the CFA-533 display using this command.



```
type: 0x16 = 2210
data_length: 2
data[0]: location code
         0 = "Data" register
         1 = "Control" register
data[1]: data to write to the selected register
```

The return packet will be:

```
type: 0x40 | 0x16 = 0x56 = 8610
data_length: 0
```

23 (0x17): Configure Key Reporting

By default, the CFA-533 reports any key event to the host. This command allows the key events to be enabled or disabled on an individual basis. The key events set to report are one of the items stored by the command [4 \(0x04\): Store Current State as Boot State \(Pg. 28\)](#).

```
#define KP_UP      0x01
#define KP_ENTER  0x02
#define KP_CANCEL 0x04
#define KP_LEFT   0x08
#define KP_RIGHT  0x10
#define KP_DOWN   0x20
```

```
type: 0x17 = 2310
data_length: 2
data[0]: press mask
data[1]: release mask
```

The return packet will be:

```
type: 0x40 | 0x17 = 0x57 = 8710
data_length: 0
```

Configure Key Reporting is one of the items stored by the command [4 \(0x04\): Store Current State as Boot State \(Pg. 28\)](#).

24 (0x18): Read Keypad, Polled Mode

In some situations, it may be convenient for the host to poll the CFA-533 for key activity. This command allows the host to detect which keys are currently pressed, which keys have been pressed since the last poll, and which keys have been released since the last poll.

This command is independent of the key reporting masks set by command [23 \(0x17\): Configure Key Reporting \(Pg. 37\)](#). All keys are always visible to this command. Typically both masks of command 23 would be set to "0" if the host is reading the keypad in polled mode.

```
#define KP_UP      0x01
#define KP_ENTER  0x02
#define KP_CANCEL 0x04
#define KP_LEFT   0x08
#define KP_RIGHT  0x10
#define KP_DOWN   0x20
```

```
type: 0x18 = 2410
data_length: 0
```



The return packet will be:

```
type: 0x40 | 0x18 = 0x58 = 8810
```

```
data_length: 3
```

```
data[0] = bit mask showing the keys currently pressed
```

```
data[1] = bit mask showing the keys that have been pressed since the last poll
```

```
data[2] = bit mask showing the keys that have been released since the last poll
```

25-27 (0x19-0x1B): (reserved)



28 (0x1C): Set ATX Switch Functionality

The combination of the CFA-533 with the Crystalfontz [WR-PWR-Y14](#) cable can be used to replace the function of the power and reset switches in a standard ATX-compatible system. The ATX Power Switch Functionality is one of the items stored by the command [4 \(0x04\): Store Current State as Boot State \(Pg. 28\)](#).

NOTE ON COMMAND 28: SET ATX SWITCH FUNCTIONALITY

The GPIO pins used for ATX control must not be configured as user GPIO. The pins must be configured to their default drive mode in order for the ATX functions to work correctly.

These settings are factory default but may be changed by the user. Please see command [34 \(0x22\): Set/Configure GPIO \(Pg. 43\)](#). These settings must be saved as the boot state.

To ensure that GPIO[1] will operate correctly as ATX SENSE, user GPIO[1] must be configured as:

```
DDD = "011: 1=Resistive Pull Up, 0=Fast, Strong Drive Down".  
F = "0: Port unused for user GPIO."
```

This configuration can be assured by sending the following command:

```
command = 34  
length = 3  
data[0] = 1  
data[1] = 0  
data[2] = 3
```

To ensure that GPIO[2] will operate correctly as ATX POWER, user GPIO[2] must be configured as:

```
DDD = "010: Hi-Z, use for input".  
F = "0: Port unused for user GPIO."
```

This configuration can be assured by sending the following command:

```
command = 34  
length = 3  
data[0] = 2  
data[1] = 0  
data[2] = 2
```

To ensure that GPIO[3] will operate correctly as ATX RESET, user GPIO[3] must be configured as:

```
DDD = "010: Hi-Z, use for input".  
F = "0: Port unused for user GPIO."
```

This configuration can be assured by sending the following command:

```
command = 34  
length = 3  
data[0] = 3  
data[1] = 0  
data[2] = 2
```

These settings must be saved as the boot state.

The RESET (GPIO[3]) and POWER CONTROL (GPIO[2]) lines on the CFA-533 are normally high-impedance—electrically, they appear to be disconnected or floating. When the CFA-533 asserts the RESET or POWER_CONTROL lines, they are momentarily driven high or low (as determined by the AUTO_POLARITY, RESET_INVERT or POWER_INVERT bits, detailed below). To end the power or reset pulse, the CFA-533 changes the lines back to high-impedance.



FOUR FUNCTIONS ENABLED BY COMMAND 28

Function 1: KEYPAD_RESET

If POWER-ON SENSE (GPIO[1]) is high, holding the green check key for 4 seconds will pulse RESET (GPIO[3]) pin for 1 second. During the 1-second pulse, the CFA-533 will show "RESET", and then the CFA-533 will reset itself, showing its boot state as if it had just powered on. Once the pulse has finished, the CFA-533 will not respond to any commands until after it has reset the host and itself.

Function 2: KEYPAD_POWER_ON

If POWER-ON SENSE (GPIO[1]) is low, pressing the green check key for 0.25 seconds will pulse POWER CONTROL (GPIO[2]) for the duration specified by in data[1] or the default of 1 second. During this time the CFA-533 will show "POWER ON", then the CFA-533 will reset itself.

Function 3: KEYPAD_POWER_OFF

If POWER-ON SENSE (GPIO[1]) is high, holding the red "X" key for 4 seconds will pulse POWER CONTROL (GPIO[2]) for the duration specified by in data[1] or the default of 1 second. If the user continues to hold the power key down, then the CFA-533 will continue to drive the line for a maximum of 5 additional seconds. During this time the CFA-533 will show "POWER OFF".

Function 4: LCD_OFF_IF_HOST_IS_OFF

If LCD_OFF_IF_HOST_IS_OFF is set, the CFA-533 will blank its screen and turn off its backlight to simulate its power being off any time POWER-ON SENSE is low.

NOTE

By default there is an internal POWER-ON-SENSE connected to the +5v pin of J_PWR, selected by setting data[2] to 1. Alternatively, GPIO[1] may be configured to act as POWER-ON-SENSE through R21 of 5K, and specifying data[2] as 0. The CFA-533 will still be active (since it is powered by V_{SB}), monitoring the keypad for a power-on keystroke. Once POWER-ON SENSE goes high, the CFA-533 will reboot as if power had just been applied to it.

```
#define AUTO_POLARITY          0x01 //Automatically detects polarity for reset and
                                //power (recommended)
#define RESET_INVERT          0x02 //Reset pin drives high instead of low
#define POWER_INVERT          0x04 //Power pin drives high instead of low
#define LCD_OFF_IF_HOST_IS_OFF 0x10
#define KEYPAD_RESET          0x20
#define KEYPAD_POWER_ON       0x40
#define KEYPAD_POWER_OFF      0x80

type: 0x1C = 2810
data_length: 1, 2 or 3
data[0]: bit mask of enabled functions
data[1]: (optional) length of power on & off pulses in 1/32 second
         1 = 1/32 sec
         2 = 1/16 sec
         16 = 1/2 sec
         255 = 8 sec
data[2]: (optional) atx_sense_on_floppy
         0: sense ATX host state on P2.1 (J8, pin 6 / GPIO [1] -- R21 must be loaded)
         1: sense ATX host state on P0.7 (JPWR,+5v -- recommended configuration)
```



The return packet will be:

```
type: 0x40 | 0x1C = 0x5C = 9210  
data_length: 0
```

29 (0x1D): Enable/Feed Host Watchdog Reset

Some high-availability systems use hardware watchdog timers to ensure that a software or hardware failure does not result in an extended system outage. Once the host system has booted, a system monitor program is started. The system monitor program would enable the watchdog timer on the CFA-533. If the system monitor program fails to feed the CFA-533's watchdog timer, the CFA-533 will reset the host system.

NOTE

The GPIO pins used for ATX control must not be configured as user GPIO. They must be configured to their default drive mode in order for the ATX functions to work correctly. These settings are factory default, but may be changed by the user. Please see the note under command [28 \(0x1C\): Set ATX Switch Functionality \(Pg. 39\)](#) or command [34 \(0x22\): Set/Configure GPIO \(Pg. 43\)](#).

```
type: 0x1D = 2910  
data_length: 1  
data[0] = enable/timeout
```

If timeout is 0, the watchdog is disabled.

If timeout is 1-255, then this command must be issued again within timeout seconds to feed the watchdog and avoid a watchdog reset.

To turn the watchdog off once it has been enabled, simply set timeout to 0.

If the command is not re-issued within timeout seconds, then the CFA-533 will reset the host (see command 28 for details). Since the watchdog is off by default when the CFA-533 powers up, the CFA-533 will not issue another host reset until the host has once again enabled the watchdog.

The return packet will be:

```
type: 0x40 | 0x1D = 0x5D = 9310  
data_length: 0
```

30 (0x1E): Read Reporting/ATX/Watchdog (debug)

This command can be used to verify the current items configured to report to the host, as well as some other miscellaneous status information. Please note that the information returned by the CFA-533 is not identical to the information returned by other models in this family (CFA-631, CFA-633, CFA-635).

```
type: 30  
data_length: 0
```



The return packet will be:

```
type: 0x1E = 3010
data_length: 15
data[0] = 0 (reserved)
data[1] = temperatures 1-8 reporting status (as set by command 19)
data[2] = temperatures 9-15 reporting status (as set by command 19)
data[3] = temperatures 16-23 reporting status (as set by command 19)
data[4] = temperatures 24-32 reporting status (as set by command 19)
data[5] = key presses (as set by command 23)
data[6] = key releases (as set by command 23)
data[7] = ATX Power Switch Functionality (as set by command 28), and
        bit 0x08 will be set if the watchdog is active
data[8] = current watchdog counter (as set by command 29)
data[9] = User Contrast Adjust (as set by command 13, data\[1\])
data[10] = Key backlight setting (as set by command 14, data\[1\])
data[11] = atx_sense_on_floppy (as set by command 28)
data[12] = 0 (reserved)
data[13] = CFA-633-style contrast setting (as set by command 13, data\[0\])
data[14] = LCD backlight setting (as set by command 14, data\[0\])
```

Please Note: Previous and future firmware versions may return fewer or additional bytes.

31 (0x1F): Send Data to LCD

This command allows data to be placed at any position on the LCD.

```
type: 0x1F = 3110
data_length: 3 to 18
data[0]: col = x = 0 to 15
data[1]: row = y = 0 to 1
data[2-21]: text to place on the LCD, variable from 1 to 16 characters
```

The return packet will be:

```
type: 0x40 | 0x1F = 0x5F = 9510
data_length: 0
```

Send Data to LCD is one of the items stored by the command [4 \(0x04\): Store Current State as Boot State \(Pg. 28\)](#).

32 (0x20): Reserved for [CFA-631](#) Key Legends

33 (0x21): Set Baud Rate

This command will change the CFA-533's baud rate. The CFA-533 will send the acknowledge packet for this command and then change its baud rate to the new value. The host should send the baud rate command, wait for a positive acknowledge from the CFA-533 at the old baud rate, and then switch itself to the new baud rate. The baud rate must be saved by the command [4 \(0x04\): Store Current State as Boot State \(Pg. 28\)](#) if you want the CFA-533 to power up at the new baud rate.

The factory default baud rate is 19200.

```
type: 0x21 = 3310
data_length: 1
data[1]:
    0 = 19200 baud
    1 = 115200 baud
```

The return packet will be:



```
type: 0x40 | 0x21 = 0x61 = 9710  
data_length: 0
```

34 (0x22): Set/Configure GPIO

The CFA-533 has five pins for user-definable general-purpose input / output (GPIO). These pins are shared with the DOW and ATX functions. Be careful when you configure the GPIO if you want to use the ATX or DOW at the same time.

The architecture of the CFA-533 allows great flexibility in the configuration of the GPIO pins. They can be set as input or output. They can output constant high or low signals or a variable duty cycle 100 Hz PWM signal.

In output mode using the PWM (and a suitable current limiting resistor), an LED may be turned on or off and even dimmed under host software control. With suitable external circuitry, the GPIOs can also be used to drive external logic or power transistors.

The CFA-533 continuously polls the GPIOs as inputs at 32 Hz. The present level can be queried by the host software at a lower rate. The CFA-533 also keeps track of whether there were rising or falling edges since the last host query (subject to the resolution of the 32 Hz sampling). This means that the host is not forced to poll quickly in order to detect short events. The algorithm used by the CFA-533 to read the inputs is inherently "bounce-free".

The GPIOs also have "pull-up" and "pull-down" modes. These modes can be useful when using the GPIO as an input connected to a switch since no external pull-up or pull-down resistor is needed. For instance, the GPIO can be set to pull up. Then when a switch connected between the GPIO and ground is open, reading the GPIO will return a "1". When the switch is closed, the input will return a "0".

Pull-up/pull-down resistance values are approximately 5KΩ. Do not exceed current of 25 mA per GPIO.

GPIO[1] may be connected to the host's power in order to sense the host's power on/off state. There is a provision for a series resistor R21 in series with GPIO[1] to limit the possibility of [latchup](#). To use GPIO[1] as a general-purpose input/output, you will need to load R21 with a resistor suitable for your application.

NOTE ON SETTING AND CONFIGURING GPIO PINS

The GPIO pins may also be used for ATX control through header J8 and temperature sensing through the CFA-533's DOW header. By factory default, the GPIO output setting, function, and drive mode are set correctly to enable operation of the ATX and DOW functions. **The GPIO output setting, function, and drive mode must be set to the correct values in order for the ATX and DOW functions to work. Improper use of this command can disable the ATX and DOW functions.** The [633_WinTest](#) will work with the CFA-533 modules and may be used to easily check and reset the GPIO configuration to the default state so the ATX and DOW functions will work.

The GPIO configuration is one of the items stored by the command [4 \(0x04\): Store Current State as Boot State \(Pg. 28\)](#).



```

type: 0x22 = 3410
data_length:
  2 bytes to change value only
  3 bytes to change value and configure function and drive mode

data[0]: index of GPIO to modify
  0 = GPIO[0] = J8, Pin 7
  1 = GPIO[1] = J8, Pin 6 (may be ATX Host Power Sense, as configured by
    command 28, data\[2\])
  2 = GPIO[2] = J8, Pin 5 (default is ATX Host Power Control)
  3 = GPIO[3] = J8, Pin 4 (default is ATX Host Reset Control)
  4 = GPIO[4] = J9, Pin 2 (default is DOW I/O--may have 1 K $\Omega$  hardware pull-up)
  5-255: reserved
  
```

Please note: Future versions of this command on future hardware models may accept additional values for data[0], which would control the state of future additional GPIO pins

```

data[1]: Pin output state (actual behavior depends on drive mode):
  0 = Output set to low
  1-99 = Output duty cycle percentage (100 Hz nominal)
  100 = Output set to high
  101-255 = invalid
  
```

data[2]: Pin function select and drive mode (optional)

```

---- FDDD
| | | | -- DDD = Drive Mode (based on output state of 1 or 0)
| | | | =====
| | | | 000: 1=Fast, Strong Drive Up, 0=Resistive Pull Down
| | | | 001: 1=Fast, Strong Drive Up, 0=Fast, Strong Drive Down
| | | | 010: Hi-Z, use for input
| | | | 011: 1=Resistive Pull Up, 0=Fast, Strong Drive Down
| | | | 100: 1=Slow, Strong Drive Up, 0=Hi-Z
| | | | 101: 1=Slow, Strong Drive Up, 0=Slow, Strong Drive Down
| | | | 110: reserved, do not use
| | | | 111: 1=Hi-Z, 0=Slow, Strong Drive Down
| | | |
| | | | ----- F = Function
| | | | =====
| | | | 0: Port unused for GPIO. It will take on the default
| | | | function such as ATX, DOW or unused. The user is
| | | | responsible for setting the drive to the correct
| | | | value in order for the default function to work
| | | | correctly.
| | | | 1: Port used for GPIO under user control. The user is
| | | | responsible for setting the drive to the correct
| | | | value in order for the desired GPIO mode to work
| | | | correctly.
| | | | ----- reserved, must be 0
  
```

The return packet will be:

```

type: 0x40 | 0x22 = 0x62 = 9810
data_length: 0
  
```

35 (0X23): Read GPIO & Configuration

Please see command [34 \(0x22\): Set/Configure GPIO \(Pg. 43\)](#) for details on the GPIO architecture.



CHARACTER GENERATOR ROM (CGROM)

To find the code for a given character, add the two numbers that are shown in bold for its row and column. For example, the superscript "9" is in the column labeled "128_d" and in the row labeled "9_d". So you would add 128 + 9 to get 137. When you send a byte with the value of 137 to the display, then a superscript "9" will be shown.

upper 4 bits lower 4 bits	0 _d 0000 ₂	16 _d 0001 ₂	32 _d 0010 ₂	48 _d 0011 ₂	64 _d 0100 ₂	80 _d 0101 ₂	96 _d 0110 ₂	112 _d 0111 ₂	128 _d 1000 ₂	144 _d 1001 ₂	160 _d 1010 ₂	176 _d 1011 ₂	192 _d 1100 ₂	208 _d 1101 ₂	224 _d 1110 ₂	240 _d 1111 ₂
0 _d 0000 ₂	CGRAM [0]															
1 _d 0001 ₂	CGRAM [1]															
2 _d 0010 ₂	CGRAM [2]															
3 _d 0011 ₂	CGRAM [3]															
4 _d 0100 ₂	CGRAM [4]															
5 _d 0101 ₂	CGRAM [5]															
6 _d 0110 ₂	CGRAM [6]															
7 _d 0111 ₂	CGRAM [7]															
8 _d 1000 ₂	CGRAM [0]															
9 _d 1001 ₂	CGRAM [1]															
10 _d 1010 ₂	CGRAM [2]															
11 _d 1011 ₂	CGRAM [3]															
12 _d 1100 ₂	CGRAM [4]															
13 _d 1101 ₂	CGRAM [5]															
14 _d 1110 ₂	CGRAM [6]															
15 _d 1111 ₂	CGRAM [7]															

Figure 10. Character Generator ROM (CGROM)



JUMPER LOCATIONS AND FUNCTIONS

The CFA533-YYH-KU has twelve jumpers. Jumpers may be closed by melting a ball of solder across their gap. You may re-open the jumpers by removing the solder. Solder wick works well for removing solder.

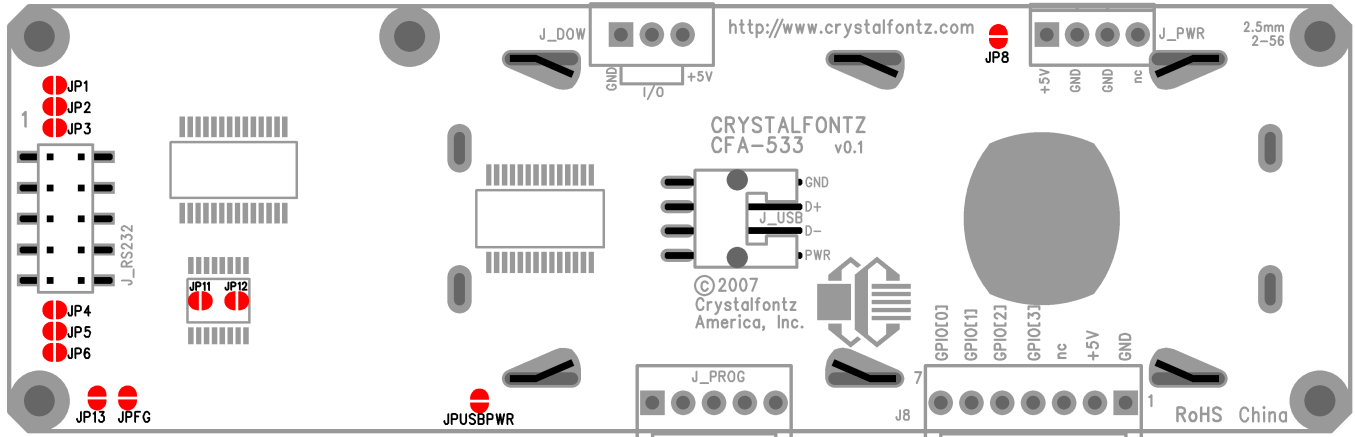

JP1	open	J1 (RS232), Pin 10 is open
	closed	LCD Tx/Host Rx to J1(RS232), Pin 10
JP2	open	J1(RS232), Pin 2 is open (see also JP3 and JP11)
	closed	LCD Tx/Host Rx to J1(RS232), Pin 2
JP3	open	J1 (RS232), Pin 2 is open (see also JP2 and JP11)
	closed	LCD Rx/Host Tx to J1(RS232), Pin 2
JP4	open	J1(RS232), Pin 3 is open (see also JP5 and JP12)
	closed	LCD Rx/Host Tx to J1(RS232), Pin 3
JP5	open	J1 (RS232), Pin 3 is open (see also JP4 and JP12)
	closed	Ground to J1(RS232), Pin 3
JP6	open	J1(RS232), Pin 5 is open
	closed	Ground to J1(RS232), Pin 5
JP8	open	+5v pin from PWR connector used only for ATX SENSE
	closed	+5v pin from PWR connector supplies power to module
JP13	open	J1 (RS232), Pin 4 is open
	closed	+5v to J1 (RS232), Pin 4
JPUSBPWR	open	Module power independent of USB
	closed	Module power supplied from USB
JPFG	open	Mounting holes and FG trace surrounding PCB are open
	closed	Mounting holes and FG trace are connected to LOGIC GND
JP11, JP12: Factory build options, do not change		

Figure 11. Jumper Locations and Functions



MODULE RELIABILITY AND LONGEVITY

MODULE RELIABILITY

ITEM	SPECIFICATION
LCD portion (excluding Keypad and Backlights)	50,000 to 100,000 hours (typical)
Keypad	1,000,000 keystrokes
LED Backlights	50,000 to 100,000 hours (typical)

MODULE LONGEVITY (EOL / REPLACEMENT POLICY)

Crystalfontz is committed to making all of our LCD modules available for as long as possible. For each module we introduce, we intend to offer it indefinitely. We do not preplan a module's obsolescence. The majority of modules we have introduced are still available.

We recognize that discontinuing a module may cause problems for some customers. However, rapidly changing technologies, component availability, or low customer order levels may force us to discontinue ("End of Life", EOL) a module. For example, we must occasionally discontinue a module when a supplier discontinues a component or a manufacturing process becomes obsolete. When we discontinue a module, we will do our best to find an acceptable replacement module with the same fit, form, and function.

In most situations, you will not notice a difference when comparing a "fit, form, and function" replacement module to the discontinued module it replaces. However, sometimes a change in component or process for the replacement module results in a slight variation, perhaps an improvement, over the previous design.

Although the replacement module is still within the stated Data Sheet specifications and tolerances of the discontinued module, changes may require modification to your circuit and/or firmware. Possible changes include:

- *Backlight LEDs.* Brightness may be affected (perhaps the new LEDs have better efficiency) or the current they draw may change (new LEDs may have a different VF).
- *Controller.* A new controller may require minor changes in your code.
- *Component tolerances.* Module components have manufacturing tolerances. In extreme cases, the tolerance stack can change the visual or operating characteristics.

Please understand that we avoid changing a module whenever possible; we only discontinue a module if we have no other option. We will post Part Change Notices (PCN) on the product's webpage as soon as possible. If interested, you can subscribe to future part change notifications.

CARE AND HANDLING PRECAUTIONS

For optimum operation of the CFA533-YYH-KU and to prolong its life, please follow the precautions described below.



ELECTROSTATIC DISCHARGE (ESD)

Please use industry standard antistatic precautions as you would for any other PCB assembly such as expansion cards or motherboards. Ground your body, work surfaces, and equipment.

DESIGN AND MOUNTING

- The exposed surface of the LCD “glass” is actually a polarizer laminated on top of the glass. To protect the soft plastic polarizer from damage, the module ships with a protective film over the polarizer. Please peel off the protective film slowly. Peeling off the protective film abruptly may generate static electricity.
- The polarizer is made out of soft plastic and is easily scratched or damaged. When handling the module, avoid touching the polarizer. Finger oils are difficult to remove.
- To protect the soft plastic polarizer from damage, place a transparent plate (for example, acrylic, polycarbonate, or glass) in front of the module, leaving a small gap between the plate and the display surface. We use GE HP-92 Lexan, which is readily available and works well.
- Do not disassemble or modify the module.
- Do not modify the tab of the metal bezel or make connections to it.
- Solder only to the I/O terminals. Use care when removing solder—it is possible to damage the PCB.
- Do not reverse polarity to the power supply connections. Reversing polarity will immediately ruin the module.

AVOID SHOCK, IMPACT, TORQUE, AND TENSION

- Do not expose the module to strong mechanical shock, impact, torque, and tension.
- Do not drop, toss, bend, or twist the module.
- Do not place weight or pressure on the module.



APPENDIX A: QUALITY ASSURANCE STANDARDS

INSPECTION CONDITIONS

- Environment
 - Temperature: $25\pm 5^{\circ}\text{C}$
 - Humidity: 30~85% RH
- For visual inspection of active display area
 - Source lighting: two 20 Watt or one 40 Watt fluorescent light
 - Display adjusted for best contrast
 - Viewing distance: 30 ± 5 cm (about 12 inches)
 - Viewable angle: inspect at 45° angle of vertical line right and left, top and bottom

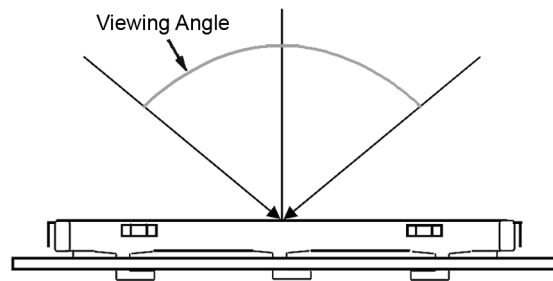

COLOR DEFINITIONS

We try to describe the appearance of our modules as accurately as possible. For the photos, we adjust or optimal appearance. Actual display appearance may vary due to (1) different operating conditions, (2) small variations of component tolerances, (3) inaccuracies of our camera, (4) color interpretation of the photos on your monitor, and/or (5) personal differences in the perception of color.

DEFINITION OF ACTIVE AREA AND VIEWABLE AREA

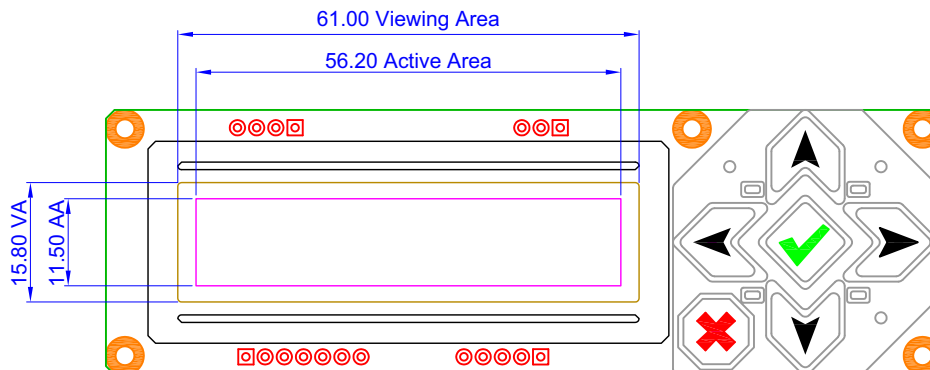



ACCEPTANCE SAMPLING

DEFECT TYPE	AQL*
Major	≤0.65%
Minor	≤1.00%
*Acceptable Quality Level: maximum allowable error rate or variation from standard	

DEFECTS CLASSIFICATION

Defects are defined as:

- Major Defect: results in failure or substantially reduces usability of unit for its intended purpose
- Minor Defect: deviates from standards but is not likely to reduce usability for its intended purpose

ACCEPTANCE STANDARDS

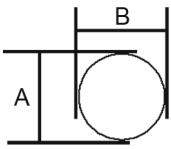
#	DEFECT TYPE	CRITERIA		MAJOR / MINOR	
1	Electrical defects	1. No display, display malfunctions, or shorted segments. 2. Current consumption exceeds specifications.		Major	
2	Viewing area defect	Viewing area does not meet specifications. (See Inspection Conditions (Pg. 50)).		Major	
3	Contrast adjustment defect	Contrast adjustment fails or malfunctions.		Major	
4	Blemishes or foreign matter on display segments		<i>Defect Size (mm)</i>	<i>Acceptable Qty</i>	Minor
			≤0.3	3	
			≤2 defects within 10 mm of each other		
5	Other blemishes or foreign matter outside of display segments	Defect size = (A + B)/2 	<i>Defect Size (mm)</i>	<i>Acceptable Qty</i>	Minor
			≤0.15	Ignore	
			0.15 to 0.20	3	
			0.20 to 0.25	2	
			0.25 to 0.30	1	

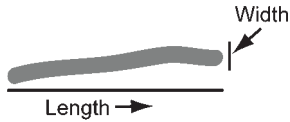
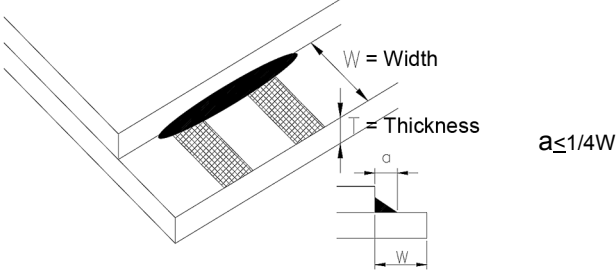
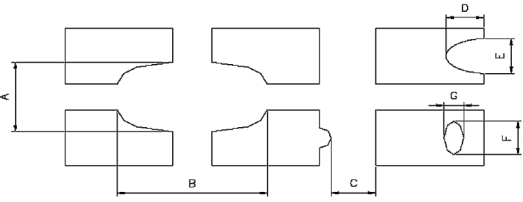

#	DEFECT TYPE	CRITERIA			MAJOR / MINOR
6	Dark lines or scratches in display area 	<i>Defect Width (mm)</i>	<i>Defect Length (mm)</i>	<i>Acceptable Qty</i>	Minor
		≤0.03	≤3.0	3	
		0.03 to 0.05	≤2.0	2	
		0.05 to 0.08	≤2.0	1	
		0.08 to 0.10	≤3.0	0	
		≥0.10	>3.0	0	
7	Bubbles between polarizer film and glass	<i>Defect Size (mm)</i>	<i>Acceptable Qty</i>	Minor	
		≤0.20	Ignore		
		0.20 to 0.40	3		
		0.40 to 0.60	2		
		≥0.60	0		
8	Glass rest defect				Minor
9	Display pattern defect				Minor
		<i>Dot Size (mm)</i>	<i>Acceptable Qty</i>		
		$((A+B)/2) \leq 0.2$	≤ 3 total defects ≤ 2 pinholes per digit		
		$C > 0$			
		$((D+E)/2) \leq 0.25$			
$((F+G)/2) \leq 0.25$					



#	DEFECT TYPE	CRITERIA	MAJOR / MINOR												
10	Chip in corner		Minor												
		<table border="1"> <thead> <tr> <th><i>a</i></th> <th><i>b</i></th> <th><i>c</i></th> <th>Acceptable Qty</th> </tr> </thead> <tbody> <tr> <td>≤4 mm</td> <td>≤W</td> <td>$c \leq T$</td> <td>3</td> </tr> </tbody> </table>		<i>a</i>	<i>b</i>	<i>c</i>	Acceptable Qty	≤4 mm	≤W	$c \leq T$	3				
		<i>a</i>		<i>b</i>	<i>c</i>	Acceptable Qty									
≤4 mm	≤W	$c \leq T$	3												
11	Chip on "non-contact" edge of LCD		Minor												
		<table border="1"> <thead> <tr> <th><i>a</i></th> <th><i>b</i></th> <th><i>c</i></th> <th>Acceptable Qty</th> </tr> </thead> <tbody> <tr> <td>≤3 mm</td> <td>≤1 mm</td> <td>≤T</td> <td>Ignore</td> </tr> <tr> <td>≤4 mm</td> <td>≤1.5 mm</td> <td>≤T</td> <td>3</td> </tr> </tbody> </table>		<i>a</i>	<i>b</i>	<i>c</i>	Acceptable Qty	≤3 mm	≤1 mm	≤T	Ignore	≤4 mm	≤1.5 mm	≤T	3
		<i>a</i>		<i>b</i>	<i>c</i>	Acceptable Qty									
		≤3 mm		≤1 mm	≤T	Ignore									
≤4 mm	≤1.5 mm	≤T	3												
12	Chip on "contact" edge of LCD, on the active side		Minor												
		<table border="1"> <thead> <tr> <th><i>a</i></th> <th><i>b</i></th> <th><i>c</i></th> <th>Acceptable Qty</th> </tr> </thead> <tbody> <tr> <td>≤2 mm</td> <td>≤W/4</td> <td>≤T</td> <td>Ignore</td> </tr> <tr> <td>≤3 mm</td> <td>≤W/4</td> <td>≤T</td> <td>3</td> </tr> </tbody> </table>		<i>a</i>	<i>b</i>	<i>c</i>	Acceptable Qty	≤2 mm	≤W/4	≤T	Ignore	≤3 mm	≤W/4	≤T	3
		<i>a</i>		<i>b</i>	<i>c</i>	Acceptable Qty									
		≤2 mm		≤W/4	≤T	Ignore									
≤3 mm	≤W/4	≤T	3												



#	DEFECT TYPE	CRITERIA	MAJOR / MINOR												
13	Chip on "contact" edge of LCD, on the inactive side		Minor												
		<table border="1"> <thead> <tr> <th><i>a</i></th> <th><i>b</i></th> <th><i>c</i></th> <th>Acceptable Qty</th> </tr> </thead> <tbody> <tr> <td>≤3 mm</td> <td>≤1 mm</td> <td>≤T</td> <td>Ignore</td> </tr> <tr> <td>≤4 mm</td> <td>≤1.5 mm</td> <td>≤T</td> <td>3</td> </tr> </tbody> </table>		<i>a</i>	<i>b</i>	<i>c</i>	Acceptable Qty	≤3 mm	≤1 mm	≤T	Ignore	≤4 mm	≤1.5 mm	≤T	3
		<i>a</i>		<i>b</i>	<i>c</i>	Acceptable Qty									
		≤3 mm		≤1 mm	≤T	Ignore									
≤4 mm	≤1.5 mm	≤T	3												
14	Chip in seal area		Minor												
		<table border="1"> <thead> <tr> <th><i>a</i></th> <th><i>b</i></th> <th><i>c</i></th> <th>Acceptable Qty</th> </tr> </thead> <tbody> <tr> <td><3 mm</td> <td>≤1.5 mm</td> <td>≤1/2 T</td> <td>3</td> </tr> </tbody> </table>		<i>a</i>	<i>b</i>	<i>c</i>	Acceptable Qty	<3 mm	≤1.5 mm	≤1/2 T	3				
		<i>a</i>		<i>b</i>	<i>c</i>	Acceptable Qty									
		<3 mm		≤1.5 mm	≤1/2 T	3									
Unacceptable if $c > 50\%$ of glass thickness or if the seal area is damaged.															
15	Backlight defects	<ol style="list-style-type: none"> 1. Light fails or flickers. (Major) 2. Color and luminance do not correspond to specifications. (Major) 3. Exceeds standards for display's blemishes or foreign matter (see test 5, Pg. 51), and dark lines or scratches (see test 6, Pg. 52). (Minor) 	See list												
16	COB defects	<ol style="list-style-type: none"> 1. Pinholes >0.2 mm. 2. Seal surface has pinholes through to the IC. 3. More than 3 locations of sealant beyond 2 mm of the sealed areas. 	Minor												
17	PCB defects	<ol style="list-style-type: none"> 1. Oxidation or contamination on connectors.* 2. Wrong parts, missing parts, or parts not in specification.* 3. Jumpers set incorrectly. 4. Solder (if any) on bezel, LED pad, zebra pad, or screw hole pad is not smooth. <p>*Minor if display functions correctly. Major if the display fails.</p>	Minor												



#	DEFECT TYPE	CRITERIA	MAJOR / MINOR
18	Soldering defects	1. Unmelted solder paste. 2. Cold solder joints, missing solder connections, or oxidation.* 3. Solder bridges causing short circuits.* 4. Residue or solder balls. 5. Solder flux is black or brown. *Minor if display functions correctly. Major if the display fails.	Minor



APPENDIX B: CALCULATING THE CRC

Below are five sample algorithms that will calculate the CRC of a CFA-533 packet. Some of the algorithms were contributed by forum members and originally written for the [CFA-631](#). The CRC used in the CFA-533 is the same one that is used in IrDA, which came from PPP, which to at least some extent seems to be related to a CCITT (ref: Network Working Group Request for Comments: 1171) standard. At that point, the trail was getting a bit cold and diverged into several referenced articles and papers, dating back to 1983.

The polynomial used is $X^{16} + X^{12} + X^5 + X^0$ (0x8408)
 The result is bit-wise inverted before being returned.

ALGORITHM 1: "C" TABLE IMPLEMENTATION

This algorithm is typically used on the host computer, where code space is not an issue.

```
//This code is from the IRDA LAP documentation, which appears to
//have been copied from PPP:
//
// http://irda.affiniscape.com/associations/2494/files/Specifications/
IrLAP11_Plus_Errata.zip
//
//I doubt that there are any worries about the legality of this code,
//searching for the first line of the table below, it appears that
//the code is already included in the linux 2.6 kernel "Driver for
//ST5481 USB ISDN modem". This is an "industry standard" algorithm
//and I do not think there are ANY issues with it at all.
word get_crc(ubyte *bufptr,word len)
{
  //CRC lookup table to avoid bit-shifting loops.
  static const word crcLookupTable[256] =
  {0x00000,0x01189,0x02312,0x0329B,0x04624,0x057AD,0x06536,0x074BF,
  0x08C48,0x09DC1,0x0AF5A,0x0BED3,0x0CA6C,0x0DBE5,0x0E97E,0x0F8F7,
  0x01081,0x00108,0x03393,0x0221A,0x056A5,0x0472C,0x075B7,0x0643E,
  0x09CC9,0x08D40,0x0BFDB,0x0AE52,0x0DAED,0x0CB64,0x0F9FF,0x0E876,
  0x02102,0x0308B,0x00210,0x01399,0x06726,0x076AF,0x04434,0x055BD,
  0x0AD4A,0x0BCC3,0x08E58,0x09FD1,0x0EB6E,0x0FAE7,0x0C87C,0x0D9F5,
  0x03183,0x0200A,0x01291,0x00318,0x077A7,0x0662E,0x054B5,0x0453C,
  0x0BDCB,0x0AC42,0x09ED9,0x08F50,0x0FBEF,0x0EA66,0x0D8FD,0x0C974,
  0x04204,0x0538D,0x06116,0x0709F,0x00420,0x015A9,0x02732,0x036BB,
  0x0CE4C,0x0DFC5,0x0ED5E,0x0FCD7,0x08868,0x099E1,0x0AB7A,0x0BAF3,
  0x05285,0x0430C,0x07197,0x0601E,0x014A1,0x00528,0x037B3,0x0263A,
  0x0DECD,0x0CF44,0x0FDDF,0x0EC56,0x098E9,0x08960,0x0BBFB,0x0AA72,
  0x06306,0x0728F,0x04014,0x0519D,0x02522,0x034AB,0x00630,0x017B9,
  0x0EF4E,0x0FEC7,0x0CC5C,0x0DDD5,0x0A96A,0x0B8E3,0x08A78,0x09BF1,
  0x07387,0x0620E,0x05095,0x0411C,0x035A3,0x0242A,0x016B1,0x00738,
  0x0FFCF,0x0EE46,0x0DCDD,0x0CD54,0x0B9EB,0x0A862,0x09AF9,0x08B70,
  0x08408,0x09581,0x0A71A,0x0B693,0x0C22C,0x0D3A5,0x0E13E,0x0F0B7,
  0x00840,0x019C9,0x02B52,0x03ADB,0x04E64,0x05FED,0x06D76,0x07CFF,
  0x09489,0x08500,0x0B79B,0x0A612,0x0D2AD,0x0C324,0x0F1BF,0x0E036,
  0x018C1,0x00948,0x03BD3,0x02A5A,0x05EE5,0x04F6C,0x07DF7,0x06C7E,
  0x0A50A,0x0B483,0x08618,0x09791,0x0E32E,0x0F2A7,0x0C03C,0x0D1B5,
  0x02942,0x038CB,0x00A50,0x01BD9,0x06F66,0x07EEF,0x04C74,0x05DFD,
  0x0B58B,0x0A402,0x09699,0x08710,0x0F3AF,0x0E226,0x0D0BD,0x0C134,
  0x039C3,0x0284A,0x01AD1,0x00B58,0x07FE7,0x06E6E,0x05CF5,0x04D7C,
  0x0C60C,0x0D785,0x0E51E,0x0F497,0x08028,0x091A1,0x0A33A,0x0B2B3,
  0x04A44,0x05BCD,0x06956,0x078DF,0x00C60,0x01DE9,0x02F72,0x03EFB,
  0x0D68D,0x0C704,0x0F59F,0x0E416,0x090A9,0x08120,0x0B3BB,0x0A232,
  0x05AC5,0x04B4C,0x079D7,0x0685E,0x01CE1,0x00D68,0x03FF3,0x02E7A,
  0x0E70E,0x0F687,0x0C41C,0x0D595,0x0A12A,0x0B0A3,0x08238,0x093B1,
  0x06B46,0x07ACF,0x04854,0x059DD,0x02D62,0x03CEB,0x00E70,0x01FF9,
  0x0F78F,0x0E606,0x0D49D,0x0C514,0x0B1AB,0x0A022,0x092B9,0x08330,
  0x07BC7,0x06A4E,0x058D5,0x0495C,0x03DE3,0x02C6A,0x01EF1,0x00F78};
```



```
register word
newCrc;
newCrc=0xFFFF;
//This algorithm is based on the IrDA LAP example.
while(len--)
    newCrc = (newCrc >> 8) ^ crcLookupTable[(newCrc ^ *bufptr++) & 0xff];

//Make this crc match the one's complement that is sent in the packet.
return(~newCrc);
}
```

ALGORITHM 2: "C" BIT SHIFT IMPLEMENTATION

This algorithm was mainly written to avoid any possible legal issues about the source of the routine (at the request of the LCDproc group). This routine was "clean" coded from the definition of the CRC. It is ostensibly smaller than the table driven approach but will take longer to execute. This routine is offered under the GPL.

```
word get_crc(ubyte *bufptr,word len)
{
    register unsigned int
        newCRC;
    //Put the current byte in here.
    ubyte
        data;
    int
        bit_count;
    //This seed makes the output of this shift based algorithm match
    //the table based algorithm. The center 16 bits of the 32-bit
    //"newCRC" are used for the CRC. The MSb of the lower byte is used
    //to see what bit was shifted out of the center 16 bit CRC
    //accumulator ("carry flag analog");
    newCRC=0x00F32100;
    while(len--)
    {
        //Get the next byte in the stream.
        data=*bufptr++;
        //Push this byte's bits through a software
        //implementation of a hardware shift & xor.
        for(bit_count=0;bit_count<=7;bit_count++)
        {
            //Shift the CRC accumulator
            newCRC>>=1;

            //The new MSB of the CRC accumulator comes
            //from the LSB of the current data byte.
            if(data&0x01)
                newCRC|=0x00800000;

            //If the low bit of the current CRC accumulator was set
            //before the shift, then we need to XOR the accumulator
            //with the polynomial (center 16 bits of 0x00840800)
            if(newCRC&0x00000080)
                newCRC^=0x00840800;
            //Shift the data byte to put the next bit of the stream
            //into position 0.
            data>>=1;
        }
    }

    //All the data has been done. Do 16 more bits of 0 data.
    for(bit_count=0;bit_count<=15;bit_count++)
    {
        //Shift the CRC accumulator
        newCRC>>=1;

        //If the low bit of the current CRC accumulator was set
```



```
//before the shift we need to XOR the accumulator with
//0x00840800.
if(newCRC&0x00000080)
    newCRC^=0x00840800;
}
//Return the center 16 bits, making this CRC match the one's
//complement that is sent in the packet.
return((~newCRC)>>8);
}
```

ALGORITHM 2B: "C" IMPROVED BIT SHIFT IMPLEMENTATION

This is simplified algorithm that implements the CRC.

```
unsigned short get_crc(unsigned char count,unsigned char *ptr)
{
    unsigned short
        crc; //Calculated CRC
    unsigned char
        i; //Loop count, bits in byte
    unsigned char
        data; //Current byte being shifted

    crc = 0xFFFF; // Preset to all 1's, prevent loss of leading zeros

    while(count--)
    {
        data = *ptr++;
        i = 8;
        do
        {
            if((crc ^ data) & 0x01)
            {
                crc >>= 1;
                crc ^= 0x8408;
            }
            else
                crc >>= 1;
            data >>= 1;
        } while(--i != 0);
    }
    return (~crc);
}
```

ALGORITHM 3: "PIC ASSEMBLY" BIT SHIFT IMPLEMENTATION

This routine was graciously donated by one of our customers.

```
;=====
; Crystalfontz CFA-533 PIC CRC Calculation Example
;
; This example calculates the CRC for the hard coded example provided
; in the documentation.
;
; It uses "This is a test. " as input and calculates the proper CRC
; of 0x93FA.
```



```
=====
#include "p16f877.inc"
=====
; CRC16 equates and storage
;-----
accuml    equ    40h    ; BYTE - CRC result register high byte
accumh    equ    41h    ; BYTE - CRC result register high low byte
datareg   equ    42h    ; BYTE - data register for shift
j         equ    43h    ; BYTE - bit counter for CRC 16 routine
Zero      equ    44h    ; BYTE - storage for string memory read
index     equ    45h    ; BYTE - index for string memory read
savchr    equ    46h    ; BYTE - temp storage for CRC routine
;
seedlo    equ    021h   ; initial seed for CRC reg lo byte
seedhi    equ    0F3h   ; initial seed for CRC reg hi byte
;
polyL     equ    008h   ; polynomial low byte
polyH     equ    084h   ; polynomial high byte
=====
;   CRC Test Program
;-----
;
;       org      0      ; reset vector = 0000H
;
;       clrf     PCLATH ; ensure upper bits of PC are cleared
;       clrf     STATUS ; ensure page bits are cleared
;       goto     main   ; jump to start of program
;
; ISR Vector
;
;       org      4      ; start of ISR
;       goto     $      ; jump to ISR when coded
;
;       org      20     ; start of main program
main
;       movlw   seedhi  ; setup intial CRC seed value.
;       movwf   accumh  ; This must be done prior to
;       movlw   seedlo  ; sending string to CRC routine.
;       movwf   accuml  ;
;       clrf   index   ; clear string read variables
;
; main1
;       movlw   HIGH InputStr ; point to LCD test string
;       movwf   PCLATH   ; latch into PCL,
;       movfw   index    ; get index
;       call    InputStr ; get character
;       movwf   Zero     ; setup for terminator test
;       movf   Zero,f    ; see if terminator
;       btfsc  STATUS,Z  ; skip if not terminator
;       goto   main2     ; else terminator reached, jump out of loop
;       call   CRC16     ; calculate new crc
;       call   SENDUART  ; send data to LCD
;       incf  index,f    ; bump index
;       goto  main1     ; loop
;
; main2
;       movlw   00h      ; shift accumulator 16 more bits.
;       call   CRC16     ; This must be done after sending
;       movlw   00h      ; string to CRC routine.
;       call   CRC16     ;
;
;       comf   accumh,f  ; invert result
;       comf   accuml,f  ;
;
;       movfw  accuml    ; get CRC low byte
;       call   SENDUART  ; send to LCD
;       movfw  accumh    ; get CRC hi byte
;       call   SENDUART  ; send to LCD
;
;
=====
```



```

stop    goto          stop          ; word result of 0x93FA is in accumh/accuml
;=====
; calculate CRC of input byte
;-----
CRC16
        movwf        savchr        ; save the input character
        movwf        datareg       ; load data register
        movlw        .8            ; setup number of bits to test
        movwf        j            ; save to incrementor
_loop
        clrc          ; clear carry for CRC register shift
        rrf          datareg,f     ; perform shift of data into CRC register
        rrf          accumh,f     ;
        rrf          accuml,f     ;
        btfss       STATUS,C     ; skip jump if if carry
        goto        _notset      ; otherwise goto next bit
        movlw       polyL        ; XOR poly mask with CRC register
        xorwf       accuml,F     ;
        movlw       polyH        ;
        xorwf       accumh,F     ;
_notset
        decfsz      j,F          ; decrement bit counter
        goto        _loop        ; loop if not complete
        movwf       savchr       ; restore the input character
        return      ; return to calling routine
;=====
; USER SUPPLIED Serial port transmit routine
;-----
SENDUART
        return          ; put serial xmit routine here
;=====
; test string storage
;-----
        org         0100h
;
InputStr
        addwf       PCL,f
        dt         7h,10h,"This is a test. ",0
;
;=====
        end

```

ALGORITHM 4: “VISUAL BASIC” TABLE IMPLEMENTATION

Visual BASIC has its own challenges as a language (such as initializing static arrays), and it is also challenging to use Visual BASIC to work with “binary” (arbitrary length character data possibly containing nulls—such as the “data” portion of the CFA-533 packet) data. This routine was adapted from the C table implementation. The complete project can be found in our forums.

```

'This program is brutally blunt. Just like VB. No apologies.
'Written by CrystalFontz America, Inc. 2004 http://www.crystalfontz.com
'Free code, not copyright copyleft or anything else.
'Some visual basic concepts taken from:
'http://www.planet-source-code.com/vb/scripts/ShowCode.asp?txtCodeId=21434&lngWId=1
'most of the algorithm is from functions in 633_WinTest:
'https://www.crystalfontz.com/product/633WinTest#docs
'Full zip of the project is available in our forum:
'http://www.crystalfontz.com/forum/showthread.php?postId=9921#post9921

```

```

Private Type WORD
  Lo As Byte
  Hi As Byte
End Type

Private Type PACKET_STRUCT
  command As Byte

```



```
data_length As Byte
data(22) As Byte
crc As WORD
End Type

Dim crcLookupTable(256) As WORD

Private Sub MSComm_OnComm()
'Leave this here
End Sub

'My understanding of visual basic is very limited--however it appears that there is no way
'to initialize an array of structures. Nice language. Fast processors, lots of memory, big
'disks, and we fill them up with this . . this . . this . . STUFF.
Sub Initialize_CRC_Lookup_Table()
  crcLookupTable(0).Lo = &H0
  crcLookupTable(0).Hi = &H0
  . . .
'For purposes of brevity in this data sheet, I have removed 251 entries of this table, the
'full source is available in our forum:
'http://www.crystalfontz.com/forum/showthread.php?postid=9921#post9921
  . . .
  crcLookupTable(255).Lo = &H78
  crcLookupTable(255).Hi = &HF
End Sub

'This function returns the CRC of the array at data for length positions
Private Function Get_CRC(ByRef data() As Byte, ByVal length As Integer) As WORD
  Dim Index As Integer
  Dim Table_Index As Integer
  Dim newCrc As WORD
  newCrc.Lo = &HFF
  newCrc.Hi = &HFF
  For Index = 0 To length - 1
    'exclusive-or the input byte with the low-order byte of the CRC register
    'to get an index into crcLookupTable
    Table_Index = newCrc.Lo Xor data(Index)
    'shift the CRC register eight bits to the right
    newCrc.Lo = newCrc.Hi
    newCrc.Hi = 0
    ' exclusive-or the CRC register with the contents of Table at Table_Index
    newCrc.Lo = newCrc.Lo Xor crcLookupTable(Table_Index).Lo
    newCrc.Hi = newCrc.Hi Xor crcLookupTable(Table_Index).Hi
  Next Index
  'Invert & return newCrc
  Get_CRC.Lo = newCrc.Lo Xor &HFF
  Get_CRC.Hi = newCrc.Hi Xor &HFF
End Function

Private Sub Send_Packet(ByRef packet As PACKET_STRUCT)
  Dim Index As Integer
  'Need to put the whole packet into a linear array
  'since you can't do type overrides. VB, gotta love it.
  Dim linear_array(26) As Byte
  linear_array(0) = packet.command
  linear_array(1) = packet.data_length
  For Index = 0 To packet.data_length - 1
    linear_array(Index + 2) = packet.data(Index)
  Next Index
  packet.crc = Get_CRC(linear_array, packet.data_length + 2)
  'Might as well move the CRC into the linear array too
  linear_array(packet.data_length + 2) = packet.crc.Lo
  linear_array(packet.data_length + 3) = packet.crc.Hi
  'Now a simple loop can dump it out the port.
  For Index = 0 To packet.data_length + 3
    MSComm.Output = Chr(linear_array(Index))
  Next Index
End Sub
```



ALGORITHM 5: "JAVA" TABLE IMPLEMENTATION

This [code was posted in our forum](#) by user "norm" as a working example of a Java CRC calculation.

```
public class CRC16 extends Object
{
    public static void main(String[] args)
    {
        byte[] data = new byte[2];
        // hw - fw
        data[0] = 0x01;
        data[1] = 0x00;
        System.out.println("hw -fw req");
        System.out.println(Integer.toHexString(compute(data)));

        // ping
        data[0] = 0x00;
        data[1] = 0x00;
        System.out.println("ping");
        System.out.println(Integer.toHexString(compute(data)));

        // reboot
        data[0] = 0x05;
        data[1] = 0x00;
        System.out.println("reboot");
        System.out.println(Integer.toHexString(compute(data)));

        // clear lcd
        data[0] = 0x06;
        data[1] = 0x00;
        System.out.println("clear lcd");
        System.out.println(Integer.toHexString(compute(data)));

        // set line 1
        data = new byte[18];
        data[0] = 0x07;
        data[1] = 0x10;
        String text = "Test Test Test ";
        byte[] textByte = text.getBytes();
        for (int i=0; i < text.length(); i++) data[i+2] = textByte[i];
        System.out.println("text 1");
        System.out.println(Integer.toHexString(compute(data)));
    }
    private CRC16()
    {
    }
    private static final int[] crcLookupTable =
    {
        0x00000, 0x01189, 0x02312, 0x0329B, 0x04624, 0x057AD, 0x06536, 0x074BF,
        0x08C48, 0x09DC1, 0x0AF5A, 0x0BED3, 0x0CA6C, 0x0DBE5, 0x0E97E, 0x0F8F7,
        0x01081, 0x00108, 0x03393, 0x0221A, 0x056A5, 0x0472C, 0x075B7, 0x0643E,
        0x09CC9, 0x08D40, 0x0BFDB, 0x0AE52, 0x0DAED, 0x0CB64, 0x0F9FF, 0x0E876,
        0x02102, 0x0308B, 0x00210, 0x01399, 0x06726, 0x076AF, 0x04434, 0x055BD,
        0x0AD4A, 0x0BCC3, 0x08E58, 0x09FD1, 0x0EB6E, 0x0FAE7, 0x0C87C, 0x0D9F5,
        0x03183, 0x0200A, 0x01291, 0x00318, 0x077A7, 0x0662E, 0x054B5, 0x0453C,
        0x0BDCB, 0x0AC42, 0x09ED9, 0x08F50, 0x0FBF7, 0x0EAE6, 0x0D8FD, 0x0C974,
        0x04204, 0x0538D, 0x06116, 0x0709F, 0x00420, 0x015A9, 0x02732, 0x036BB,
        0x0CE4C, 0x0DFC5, 0x0ED5E, 0x0FCD7, 0x08868, 0x099E1, 0x0AB7A, 0x0BAF3,
        0x05285, 0x0430C, 0x07197, 0x0601E, 0x014A1, 0x00528, 0x037B3, 0x0263A,
        0x0DECD, 0x0CF44, 0x0FDDF, 0x0EC56, 0x098E9, 0x08960, 0x0BBFB, 0x0AA72,
        0x06306, 0x0728F, 0x04014, 0x0519D, 0x02522, 0x034AB, 0x00630, 0x017B9,
        0x0EF4E, 0x0FEC7, 0x0CC5C, 0x0DDD5, 0x0A96A, 0x0B8E3, 0x08A78, 0x09BF1,
        0x07387, 0x0620E, 0x05095, 0x0411C, 0x035A3, 0x0242A, 0x016B1, 0x00738,
        0x0FFCF, 0x0EE46, 0x0DCDD, 0x0CD54, 0x0B9EB, 0x0A862, 0x09AF9, 0x08B70,
        0x08408, 0x09581, 0x0A71A, 0x0B693, 0x0C22C, 0x0D3A5, 0x0E13E, 0x0F0B7,
        0x00840, 0x019C9, 0x02B52, 0x03ADB, 0x04E64, 0x05FED, 0x06D76, 0x07CFF,
        0x09489, 0x08500, 0x0B79B, 0x0A612, 0x0D2AD, 0x0C324, 0x0F1BF, 0x0E036,
        0x018C1, 0x00948, 0x03BD3, 0x02A5A, 0x05EE5, 0x04F6C, 0x07DF7, 0x06C7E,
    }
```



```

0x0A50A,0x0B483,0x08618,0x09791,0x0E32E,0x0F2A7,0x0C03C,0x0D1B5,
0x02942,0x038CB,0x00A50,0x01BD9,0x06F66,0x07EEF,0x04C74,0x05DFD,
0x0B58B,0x0A402,0x09699,0x08710,0x0F3AF,0x0E226,0x0D0BD,0x0C134,
0x039C3,0x0284A,0x01AD1,0x00B58,0x07FE7,0x06E6E,0x05CF5,0x04D7C,
0x0C60C,0x0D785,0x0E51E,0x0F497,0x08028,0x091A1,0x0A33A,0x0B2B3,
0x04A44,0x05BCD,0x06956,0x078DF,0x00C60,0x01DE9,0x02F72,0x03EFB,
0x0D68D,0x0C704,0x0F59F,0x0E416,0x090A9,0x08120,0x0B3BB,0x0A232,
0x05AC5,0x04B4C,0x079D7,0x0685E,0x01CE1,0x00D68,0x03FF3,0x02E7A,
0x0E70E,0x0F687,0x0C41C,0x0D595,0x0A12A,0x0B0A3,0x08238,0x093B1,
0x06B46,0x07ACF,0x04854,0x059DD,0x02D62,0x03CEB,0x00E70,0x01FF9,
0x0F78F,0x0E606,0x0D49D,0x0C514,0x0B1AB,0x0A022,0x092B9,0x08330,
0x07BC7,0x06A4E,0x058D5,0x0495C,0x03DE3,0x02C6A,0x01EF1,0x00F78
};
public static int compute(byte[] data)
{
  int newCrc = 0xFFFF;
  for (int i = 0; i < data.length; i++ )
  {
    int lookup = crcLookupTable[(newCrc ^ data[i]) & 0xFF];
    newCrc = (newCrc >> 8) ^ lookup;
  }
  return(~newCrc);
}
}

```

ALGORITHM 6: “PERL” TABLE IMPLEMENTATION

This code was translated from the C version by one of our customers.

```

#!/usr/bin/perl

use strict;

my @CRC_LOOKUP =
(0x00000,0x01189,0x02312,0x0329B,0x04624,0x057AD,0x06536,0x074BF,
0x08C48,0x09DC1,0x0AF5A,0x0BED3,0x0CA6C,0x0DBE5,0x0E97E,0x0F8F7,
0x01081,0x00108,0x03393,0x0221A,0x056A5,0x0472C,0x075B7,0x0643E,
0x09CC9,0x08D40,0x0BFDB,0x0AE52,0x0DAED,0x0CB64,0x0F9FF,0x0E876,
0x02102,0x0308B,0x00210,0x01399,0x06726,0x076AF,0x04434,0x055BD,
0x0AD4A,0x0BCC3,0x08E58,0x09FD1,0x0EB6E,0x0FAE7,0x0C87C,0x0D9F5,
0x03183,0x0200A,0x01291,0x00318,0x077A7,0x0662E,0x054B5,0x0453C,
0x0BDCB,0x0AC42,0x09ED9,0x08F50,0x0FBEF,0x0EA66,0x0D8FD,0x0C974,
0x04204,0x0538D,0x06116,0x0709F,0x00420,0x015A9,0x02732,0x036BB,
0x0CE4C,0x0DFC5,0x0ED5E,0x0FCD7,0x08868,0x099E1,0x0AB7A,0x0BAF3,
0x05285,0x0430C,0x07197,0x0601E,0x014A1,0x00528,0x037B3,0x0263A,
0x0DECD,0x0CF44,0x0FDDF,0x0EC56,0x098E9,0x08960,0x0BBFB,0x0AA72,
0x06306,0x0728F,0x04014,0x0519D,0x02522,0x034AB,0x00630,0x017B9,
0x0EF4E,0x0FEC7,0x0CC5C,0x0DDD5,0x0A96A,0x0B8E3,0x08A78,0x09BF1,
0x07387,0x0620E,0x05095,0x0411C,0x035A3,0x0242A,0x016B1,0x00738,
0x0FFCF,0x0EE46,0x0DCDD,0x0CD54,0x0B9EB,0x0A862,0x09AF9,0x08B70,
0x08408,0x09581,0x0A71A,0x0B693,0x0C22C,0x0D3A5,0x0E13E,0x0F0B7,
0x00840,0x019C9,0x02B52,0x03ADB,0x04E64,0x05FED,0x06D76,0x07CFF,
0x09489,0x08500,0x0B79B,0x0A612,0x0D2AD,0x0C324,0x0F1BF,0x0E036,
0x018C1,0x00948,0x03BD3,0x02A5A,0x05EE5,0x04F6C,0x07DF7,0x06C7E,
0x0A50A,0x0B483,0x08618,0x09791,0x0E32E,0x0F2A7,0x0C03C,0x0D1B5,
0x02942,0x038CB,0x00A50,0x01BD9,0x06F66,0x07EEF,0x04C74,0x05DFD,
0x0B58B,0x0A402,0x09699,0x08710,0x0F3AF,0x0E226,0x0D0BD,0x0C134,
0x039C3,0x0284A,0x01AD1,0x00B58,0x07FE7,0x06E6E,0x05CF5,0x04D7C,
0x0C60C,0x0D785,0x0E51E,0x0F497,0x08028,0x091A1,0x0A33A,0x0B2B3,
0x04A44,0x05BCD,0x06956,0x078DF,0x00C60,0x01DE9,0x02F72,0x03EFB,
0x0D68D,0x0C704,0x0F59F,0x0E416,0x090A9,0x08120,0x0B3BB,0x0A232,
0x05AC5,0x04B4C,0x079D7,0x0685E,0x01CE1,0x00D68,0x03FF3,0x02E7A,
0x0E70E,0x0F687,0x0C41C,0x0D595,0x0A12A,0x0B0A3,0x08238,0x093B1,
0x06B46,0x07ACF,0x04854,0x059DD,0x02D62,0x03CEB,0x00E70,0x01FF9,
0x0F78F,0x0E606,0x0D49D,0x0C514,0x0B1AB,0x0A022,0x092B9,0x08330,
0x07BC7,0x06A4E,0x058D5,0x0495C,0x03DE3,0x02C6A,0x01EF1,0x00F78);

```



```
# our test packet read from an enter key press over the serial line:
#   type: 80      (key press)
#   data_length: 1    (1 byte of data)
#   data = 5

my $type: '80';
my $length = '01';
my $data = '05';
my $packet = chr(hex $type) . chr(hex $length) . chr(hex $data) ;

my $valid_crc = '5584' ;

print "A CRC of Packet ($packet) Should Equal ($valid_crc)\n";

my $crc = 0xFFFF ;

printf("%x\n", $crc);

foreach my $char (split //, $packet)
{
  # newCrc = (newCrc >> 8) ^ crcLookupTable[(newCrc ^ *bufptr++) & 0xff];
  # & is bitwise AND
  # ^ is bitwise XOR
  # >> bitwise shift right
  $crc = ($crc >> 8) ^ $CRC_LOOKUP[( $crc ^ ord($char) ) & 0xFF] ;
  # print out the running crc at each byte
  printf("%x\n", $crc);
}

# get the complement
$crc = ~$crc ;
$crc = ($crc & 0xFFFF) ;

# print out the crc in hex
printf("%x\n", $crc);
```





APPENDIX C: CONNECTING A DS2450 1-WIRE QUAD A/D CONVERTER

This appendix describes a simple test circuit that demonstrates how to connect a Dallas Semiconductor DS2450 4-channel ADC to the CFA-533's "DOW" (Dallas One Wire) connector. It also gives a sample command sequence to initialize and read the ADC.

Up to 32 DOW devices can be connected to the CFA-533. In this example the DS2450 appears at device index 0. Your software should query the connected devices using command [18 \(0x12\): Read DOW Device Information \(Pg. 33\)](#) to verify the locations and types of DOW devices connected in your application.

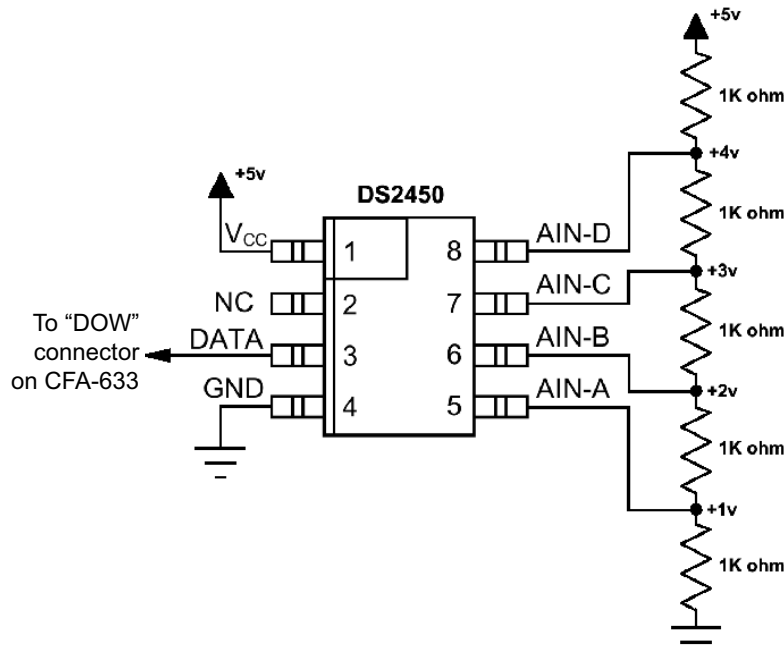
Please refer to the [DS2450 Data Sheet](#) and the description for command [20 \(0x14\): Arbitrary DOW Transaction \(Pg. 35\)](#) more information.



Appendix C Figure 1. Test Circuit Schematic

Start [633 WinTest](#) (works with CFA-533) and open the Packet Debugger dialog.

Select Command 20 = Arbitrary DOW Transaction, then paste each string below into the data field and send the packet. The response should be similar to what is shown.



```
//Write 0x40 (=64) to address 0x1C (=28) to leave analog circuitry on
//(see page 6 of the data sheet)
<command 20> \000\002\085\028\000\064
<response> C=84(d=0):2E,05,22 //16 bit "i-button" CRC + 8-bit "DOW" CRC
//Consult "i-button" docs to check 16-bit CRC
//DOW CRC is probably useless for this device.

//Write all 8 channels of control/status (16 bits, 5.10v range)
<command 20> \000\002\085\008\000\000 // address = 8, channel A low
<response> C=84(d=0):6F,F1,68 // 16-bits, output off

<command 20> \000\002\085\009\000\001 // address = 9, channel A high
<response> C=84(d=0):FF,F1,AB // no alarms, 5.1v

<command 20> \000\002\085\010\000\000 // address = 10, channel B low
<response> C=84(d=0):CE,31,88 // 16-bits, output off

<command 20> \000\002\085\011\000\001 // address = 11, channel B high
<response> C=84(d=0):5E,31,4B // no alarms, 5.1v

<command 20> \000\002\085\012\000\000 // address = 12, channel C low
<response> C=84(d=0):2E,30,A3 // 16-bits, output off

<command 20> \000\002\085\013\000\001 // address = 13, channel C high
<response> C=84(d=0):BE,30,60 // no alarms, 5.1v

<command 20> \000\002\085\014\000\000 // address = 14, channel D low
<response> C=84(d=0):8F,F0,43 // 16-bits, output off

<command 20> \000\002\085\015\000\001 // address = 15, channel D high
<response> C=84(d=0):1F,F0,80 // no alarms, 5.1v

//Read all 4 channels of control/status (check only)
<command 20> \000\010\170\008\000
<response> C=84(d=0):00,01,00,01,00,01,00,01,E0,CF,01

//Repeat next two commands for each conversion (two cycles shown)

//Start conversion on all channels
<command 20> \000\002\060\015\000
<response> C=84(d=0):3A,03,28

//Read all 8 channels
<command 20> \000\010\170\000\000
<response> C=84(d=0):00,33,DF,64,84,96,6A,C8,5A,6B,BE

//Decoded response:
0x3300 = 130561.016015625 volts (channel A)
0x64DF = 258232.009541321 volts (channel B)
0x9684 = 385322.998553467 volts (channel C)
0xC86A = 513063.992623901 volts (channel D)

//Start conversion on all channels
<command 20> \000\002\060\015\000
<response> C=84(d=0):3A,03,28

//Read all 8 channels
<command 20> \000\010\170\000\000
<response> C=84(d=0):6B,33,B2,64,97,96,42,C8,0F,C9,0A

//Decoded response:
0x336B = 131631.024342346 volts (channel A)
0x64B2 = 257782.006039429 volts (channel B)
0x9697 = 385513.000032043 volts (channel C)
0xC842 = 512663.989511108 volts (channel D)
```