

Crystalfontz America, Inc.

SPECIFICATION

CUSTOMER : _____

MODULE NO.: CFAG240128L-TMI-TZ-TS

SALES BY	APPROVED BY	CHECKED BY	PREPARED BY
ISSUED DATE:			

Crystalfontz America, Inc.

12412 East Saltese Avenue
Spokane Valley, WA 99216-0357

Phone: (888) 206-9720

Fax: (509) 892-1203

Email: techinfo@crystalfontz.com

URL: www.crystalfontz.com

Contents

1. Module Classification Information
 2. Precautions in use of LCD Modules
 3. General Specification
 4. Absolute Maximum Ratings
 5. Electrical Characteristics
 6. Optical Characteristics
 7. Interface Description
 8. Contour Drawing & Block Diagram
 9. Display Control Instruction
 10. Timing Characteristics
 11. Reliability
 12. Touch panel Information
 13. Backlight Information
 14. Material List of Components for RoHS
- Appendix: JST XHP-3 Backlight Connector

1.Module Classification Information

CFA G 2 4 0 1 2 8 L T M I TZ-TS

① ② ③ ④ ⑤ ⑥ ⑦ ⑧

①	Brand: CRYSTALFONTZ AMERICA, INC													
②	Display Type: H→Character Type, G→Graphic Type													
③	Displays Logical Dimensions: 240 Pixels x 128 Pixels													
④	Model PCB Variant: L													
⑤	Backlight Type:	<table border="0"> <tr> <td>N→Without backlight</td> <td>T→LED, White</td> </tr> <tr> <td>B→EL, Blue green</td> <td>A→LED, Amber</td> </tr> <tr> <td>D→EL, Green</td> <td>R→LED, Red</td> </tr> <tr> <td>W→EL, White</td> <td>O→LED, Orange</td> </tr> <tr> <td>F→CCFL, White</td> <td>G→LED, Green</td> </tr> <tr> <td>Y→LED, Yellow Green</td> <td></td> </tr> </table>	N→Without backlight	T→LED, White	B→EL, Blue green	A→LED, Amber	D→EL, Green	R→LED, Red	W→EL, White	O→LED, Orange	F→CCFL, White	G→LED, Green	Y→LED, Yellow Green	
N→Without backlight	T→LED, White													
B→EL, Blue green	A→LED, Amber													
D→EL, Green	R→LED, Red													
W→EL, White	O→LED, Orange													
F→CCFL, White	G→LED, Green													
Y→LED, Yellow Green														
⑥	LCD Mode:	<table border="0"> <tr> <td>B→TN Positive, Gray</td> <td>T→FSTN Negative</td> </tr> <tr> <td>N→TN Negative,</td> <td></td> </tr> <tr> <td>G→STN Positive, Gray</td> <td></td> </tr> <tr> <td>Y→STN Positive, Yellow Green</td> <td></td> </tr> <tr> <td>M→STN Negative, Blue</td> <td></td> </tr> <tr> <td>F→FSTN Positive</td> <td></td> </tr> </table>	B→TN Positive, Gray	T→FSTN Negative	N→TN Negative,		G→STN Positive, Gray		Y→STN Positive, Yellow Green		M→STN Negative, Blue		F→FSTN Positive	
B→TN Positive, Gray	T→FSTN Negative													
N→TN Negative,														
G→STN Positive, Gray														
Y→STN Positive, Yellow Green														
M→STN Negative, Blue														
F→FSTN Positive														
⑦	LCD Polarizer Type/ Temperature range/ View direction	<table border="0"> <tr> <td>A→Reflective, N.T, 6:00</td> <td>H→Transflective, W.T,6:00</td> </tr> <tr> <td>D→Reflective, N.T, 12:00</td> <td>K→Transflective, W.T,12:00</td> </tr> <tr> <td>G→Reflective, W. T, 6:00</td> <td>C→Transmissive, N.T,6:00</td> </tr> <tr> <td>J→Reflective, W. T, 12:00</td> <td>F→Transmissive, N.T,12:00</td> </tr> <tr> <td>B→Transflective, N.T,6:00</td> <td>I→Transmissive, W. T, 6:00</td> </tr> <tr> <td>E→Transflective, N.T.12:00</td> <td>L→Transmissive, W.T,12:00</td> </tr> </table>	A→Reflective, N.T, 6:00	H→Transflective, W.T,6:00	D→Reflective, N.T, 12:00	K→Transflective, W.T,12:00	G→Reflective, W. T, 6:00	C→Transmissive, N.T,6:00	J→Reflective, W. T, 12:00	F→Transmissive, N.T,12:00	B→Transflective, N.T,6:00	I→Transmissive, W. T, 6:00	E→Transflective, N.T.12:00	L→Transmissive, W.T,12:00
A→Reflective, N.T, 6:00	H→Transflective, W.T,6:00													
D→Reflective, N.T, 12:00	K→Transflective, W.T,12:00													
G→Reflective, W. T, 6:00	C→Transmissive, N.T,6:00													
J→Reflective, W. T, 12:00	F→Transmissive, N.T,12:00													
B→Transflective, N.T,6:00	I→Transmissive, W. T, 6:00													
E→Transflective, N.T.12:00	L→Transmissive, W.T,12:00													
⑧	Special Code	T→Built in negative voltage & Temperature Compensation ; Z→IC NT7086 ; TS→4 wire analog touch screen;												

2.Precautions in use of LCD Modules

- (1) Avoid applying excessive shocks to the module or making any alterations or modifications to it.
- (2) Don't make extra holes on the printed circuit board, modify its shape or change the components of LCD module.
- (3) Don't disassemble the LCM.
- (4) Don't operate it above the absolute maximum rating.
- (5) Don't drop, bend or twist LCM.
- (6) Soldering: only to the I/O terminals.
- (7) Storage: please storage in anti-static electricity container and clean environment.

3.General Specification

Item	Dimension	Unit
Number of Characters	240 x 128	□
Module dimension	150.0 x 82.0 x 15.8(MAX)	mm
View area	114.0 x 64.0	mm
Active area	107.98 x 57.58	mm
Dot size	0.43 x 0.43	mm
Dot pitch	0.45 x 0.45	mm
LCD type	STN, Negative, Transmissive, Blue	
Duty	1/128	
View direction	6 o'clock	
Backlight Type	LED, White	

4. Absolute Maximum Ratings

Item	Symbol	Min	Typ	Max	Unit
Operating Temperature	T_{OP}	-20	□	+70	°C
Storage Temperature	T_{ST}	-30	□	+80	°C
Input Voltage	V_I	V_{SS}	□	V_{DD}	V
Supply Voltage For Logic	$V_{DD}-V_{SS}$	-0.3	□	+7	V
Supply Voltage For LCD	$V_{DD}-V_0$	0	□	27	V
Negative Voltage Output	V_{EE}	□	-22V	□	V

5. Electrical Characteristics

Item	Symbol	Condition	Min	Typ	Max	Unit
Supply Voltage For Logic	$V_{DD}-V_{SS}$	□	4.75	5.0	5.25	V
Supply Voltage For LCD	$V_{DD}-V_0$	$T_a = -20^\circ\text{C}$	□	□	20.1	V
		$T_a = 25^\circ\text{C}$	□	18.9	□	V
		$T_a = -70^\circ\text{C}$	16.3	□	□	V
Input High Volt.	V_{IH}	□	$V_{DD}-2.2$	□	V_{DD}	V
Input Low Volt.	V_{IL}	□	0	□	0.8	V
Output High Volt.	V_{OH}	□	$V_{DD}-0.3$	□	V_{DD}	V
Output Low Volt.	V_{OL}	□	0	□	0.3	V
Supply Current	I_{DD}	$V_{DD}=5V$	□	28.2	□	mA

6. Optical Characteristics

Item	Symbol	Condition	Min	Typ	Max	Unit
View Angle	(V) θ	CR \geq 5	20	\square	40	deg
	(H) ϕ	CR \geq 5	-30	\square	30	deg
Contrast Ratio	CR	\square	\square	3	\square	\square
Response Time	T rise	\square	\square	200	300	ms
	T fall	\square	\square	200	300	ms

Definition of Operation Voltage (Vop)

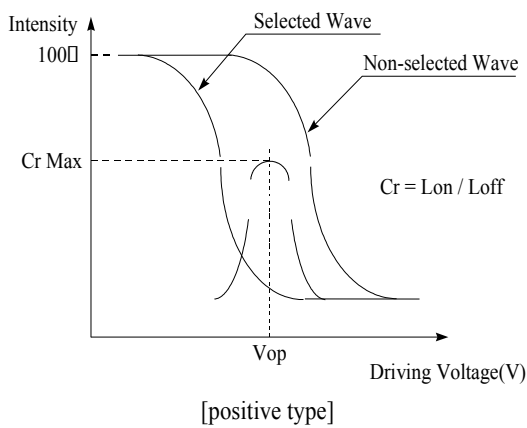

Definition of Response Time (Tr, Tf)

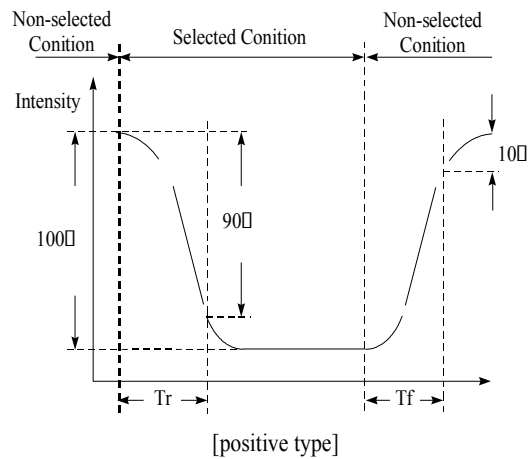

Conditions :

Operating Voltage : Vop

Viewing Angle(θ \square ϕ) : 0° \square 0°

Frame Frequency : 64 HZ Driving Waveform : 1/N duty , 1/a bias

Definition of viewing angle(CR \square 2)

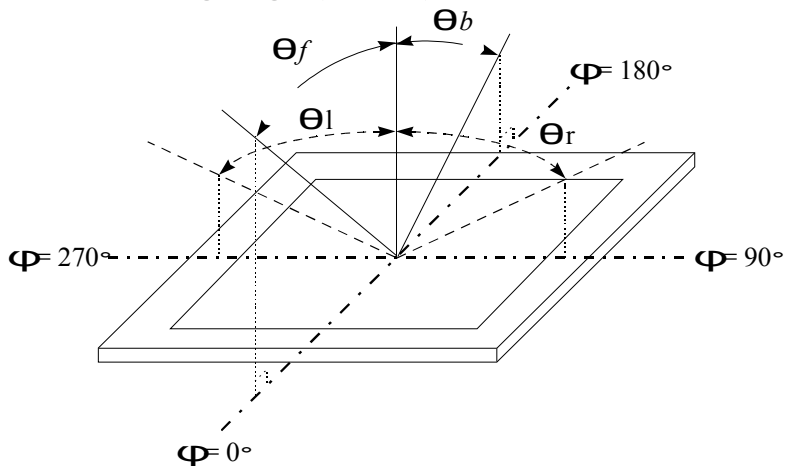

7.Interface Description

□

Pin No.	Symbol	Level	Description
1	FG	□	Frame ground (Connected to bezel)
2	Vss	□	GND
3	Vdd	□	Power supply (+5 V)
4	Vo	□	Power supply for LCD driver
5	WR	L	Data write. Write data into T6963C when WR = L
6	RD	L	Data read. Read data from T6963C when RD = L
7	CE	L	L : Chip enable
8	C/D	H / L	WR=L , C/D=H : Command Write C/D=L: Data write RD=L , C/D=H : Status Read C/D=L: Data read
9	Vee	□	Negative voltage
10	RESET	H / L	H : Normal ; L : Initialize T6963C
11	DB0	H / L	Data bus line
12	DB1	H / L	Data bus line
13	DB2	H / L	Data bus line
14	DB3	H / L	Data bus line
15	DB4	H / L	Data bus line
16	DB5	H / L	Data bus line
17	DB6	H / L	Data bus line
18	DB7	H / L	Data bus line
19	FS	MD2	Pins for selection of font; H : 6 * 8 , L : 8 * 8
20	RV	H / L	H: Reverse H: Normal

8. Contour Drawing & Block Diagram

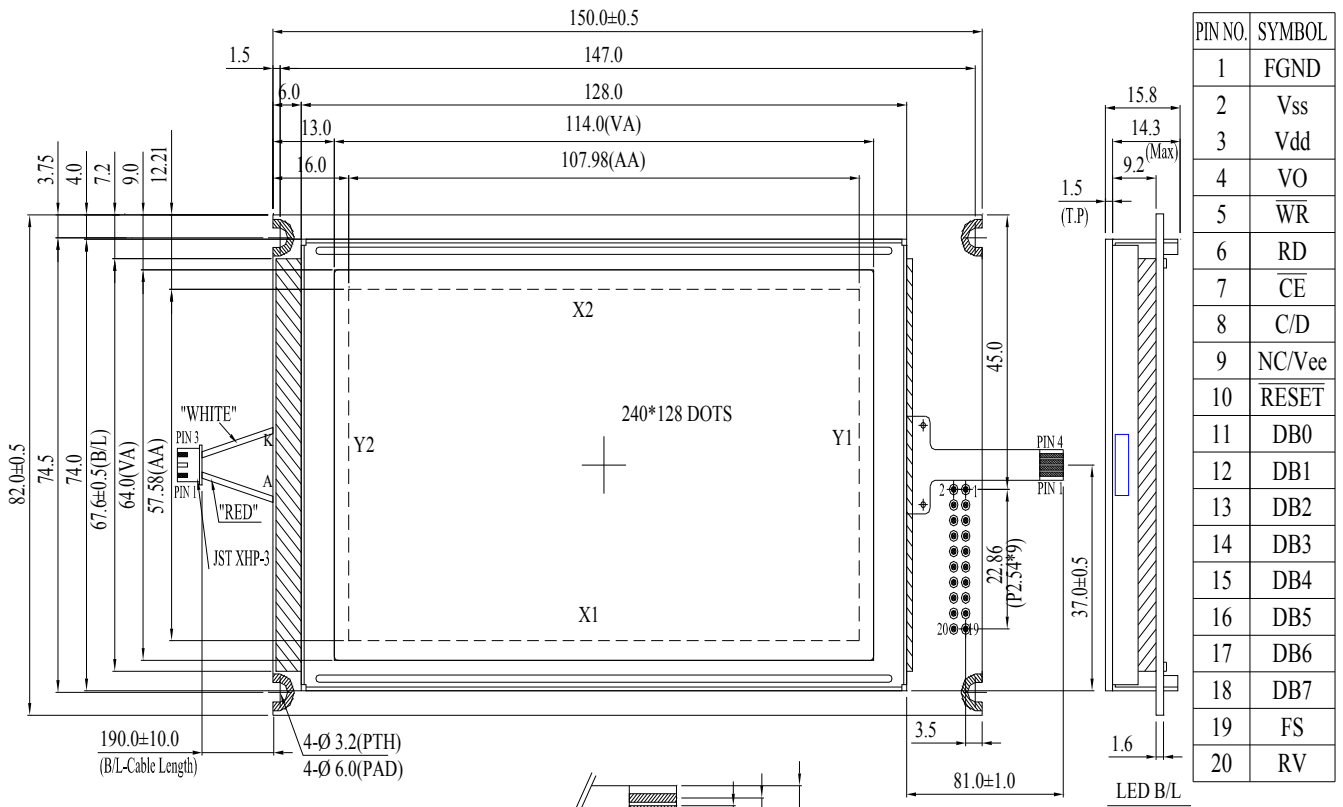

PIN NO.	SYMBOL
1	FGND
2	Vss
3	Vdd
4	VO
5	WR
6	RD
7	CE
8	C/D
9	NC/Vee
10	RESET
11	DB0
12	DB1
13	DB2
14	DB3
15	DB4
16	DB5
17	DB6
18	DB7
19	FS
20	RV

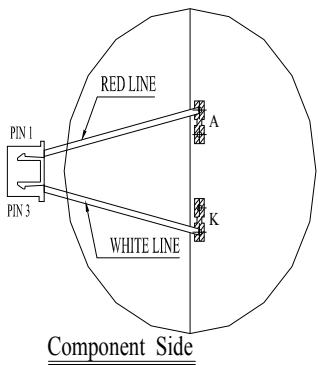

Component Side

PIN NO.	SYMBOL
1	RED
2	NC
3	WHITE

PIN NO.	Assignment
1	X1
2	Y1
3	X2
4	Y2

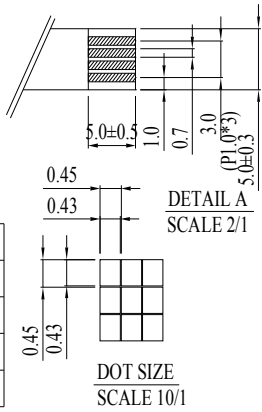

The non-specified tolerance of dimension is ±0.3mm.

9. Display control instruction

The LCD Module has built in a T6963C LSI controller, It has an 8-bit parallel data bus and control lines for writing or reading through an MPU interface, it has a 128-word character generator ROM (refer to Table 1.), which can control an external display RAM of up to 8K bytes. Allocation of text, graphics and external character generator RAM can be made easily and the display window can be moved freely within the allocated memory range.

•RAM Interface

The external RAM is used to store display data(text, graphic and external CG data). It can be freely allocated to the memory area(8 K byte max).

Recommend

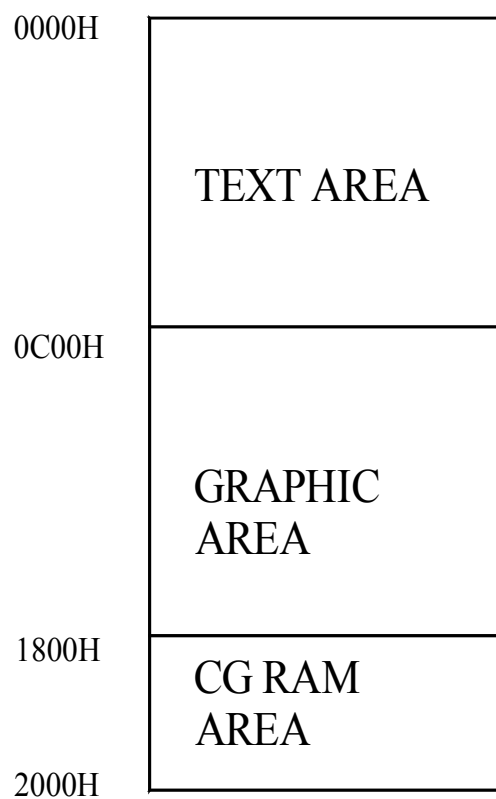

Status Checking flow

(a) □ □ □ □ □ □ □ □ □ □ □ □ □ □

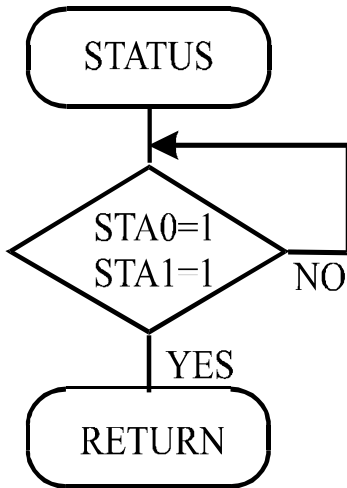

(b)

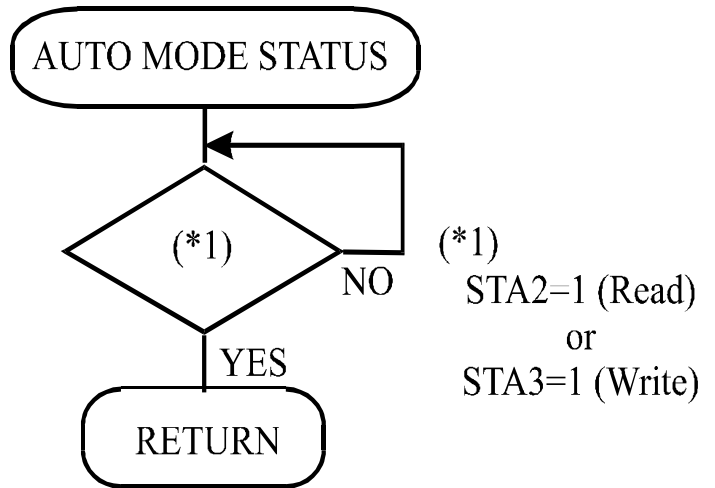

(Note 4) When using the MSB=0 command, a Status Read must be performed.

If a status check is not carried out, the T6963C cannot operate normally, even after a delay time.

The hardware interrupt occurs during the address calculation period (at the end of each line).

If a MSB=0 command is sent to the T6963C during this period, the T6963C enters Wait status.

If a status check is not carried out in this state before the next command is sent, there is the possibility that the command or data data will not be received.

(2) Setting date

When using the T6963C, first set the data, then set the command.

Procedure for sending a command

(a) The case of 1 data □ □ □ □ □ □ □

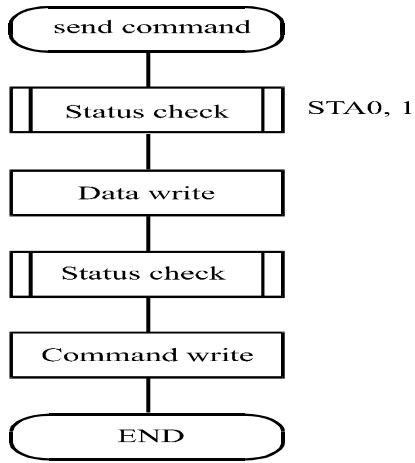

(b) The case of 2 data □ □ □ □ □ □ □

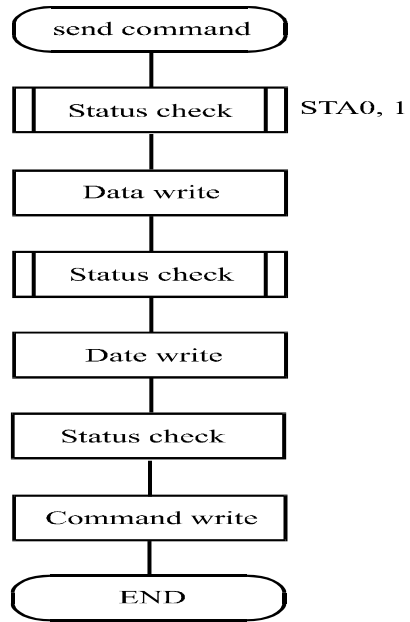

(Note) When sending more than two data, the last datum (or last two data) is valid.

□ COMMAND DEFINITIONS

COMMAND	CODE	D1	D2	FUNCTION
REGISTERS SETTING	00100001	X address	Y address	Set Cursor Pointer
	00100010	Date	00H	Set Offset Register
	00100100	Low address	High address	Set Address Pointer
SET CONTROL WORD	01000000	Low address	High address	Set Text Home Address
	01000001	Columns	00H	Set Text Area
	01000010	Low address	High address	Set Graphic Home Address
	01000011	Columns	00H	Set Graphic Area
MODE SET	1000×000	□	□	OR mode
	1000×001	□	□	EXOR mode
	1000×011	□	□	AND mode
	1000×100	□	□	Text Attribute mode
	10000×××	□	□	Internal CG ROM mode
	10001×××	□	□	External CG RAM mode
DISPLAY MODE	10010000	□	□	Display off
	1001××10	□	□	Cursor on, blink off
	1001××11	□	□	Cursor on, blink on
	100101××	□	□	Text on, graphic off
	100110××	□	□	Text off, graphic on
	100111××	□	□	Text on, graphic on
CURSOR PATTERN SELECT	10100000	□	□	1-line cursor
	10100001	□	□	2-line cursor
	10100010	□	□	3-line cursor
	10100011	□	□	4-line cursor
	10100100	□	□	5-line cursor
	10100101	□	□	6-line cursor
	10100110	□	□	7-line cursor
	10100111	□	□	8-line cursor
DATA AUTO READ/WRITE	10110000	□	□	Set Data Auto Write
	10110001	□	□	Set Data Auto Read
	10110010	□	□	Auto Reset
DATA READ/WRITE	11000000	Data	□	Data Write and Increment ADP
	11000001	□	□	Data Read and Increment ADP
	11000010	Data	□	Data Write and Decrement ADP
	11000011	□	□	Data Read and Decrement ADP Data
	11000100	Data	□	Write and Nonvariable ADP
	11000101	□	□	Data Read and Nonvariable ADP
SCREEN PEEK	11100000	□	□	Screen Peek

X : invalid

COMMAND	CODE	D1	D2	FUNCTION
SCREEN COPY	11101000	□	□	Screen Copy
BIT SET/RESET	11110×××	□	□	Bit Reset
	11111×××	□	□	Bit Set
	1111× 001	□	□	Bit 0 (LSB)
	1111× 001	□	□	Bit 1
	1111× 010	□	□	Bit 2
	1111× 011	□	□	Bit 3
	1111× 100	□	□	Bit 4
	1111× 101	□	□	Bit 5
	1111× 110	□	□	Bit 6
	1111× 110	□	□	Bit 7 (MSB)

X: invalid

Setting registers CODE	HEX.	FUNCTION	D1	D2
00100001	21H	SET CURSOR POINTER	X ADRS	Y ADRS
00100010	23H	SET OFFSET REGISTER	DATA	00H
00100100	24H	SET ADDRESS POINTER	LOW ADRS	HIGH ADRS

(1) Set Cursor Pointer

The position of the cursor is specified by X ADRS and Y ADRS. The cursor position can only be moved by this command. Data read/write from the MPU never changes the cursor pointer. X ADRS and Y ADRS are specified as follows.

X ADRS 00H to 4FH (lower 7 bits are valid)

Y ADRS 00H to 1FH (lower 5 bits are valid)

Single-Scan

X ADRS 00 to 4FH

Y ADRS 00H to 0FH

(2) Set Offset Register

The offset register is used to determine the external character generator RAM area.

The T6963C has a 16-bit address bus as follows.

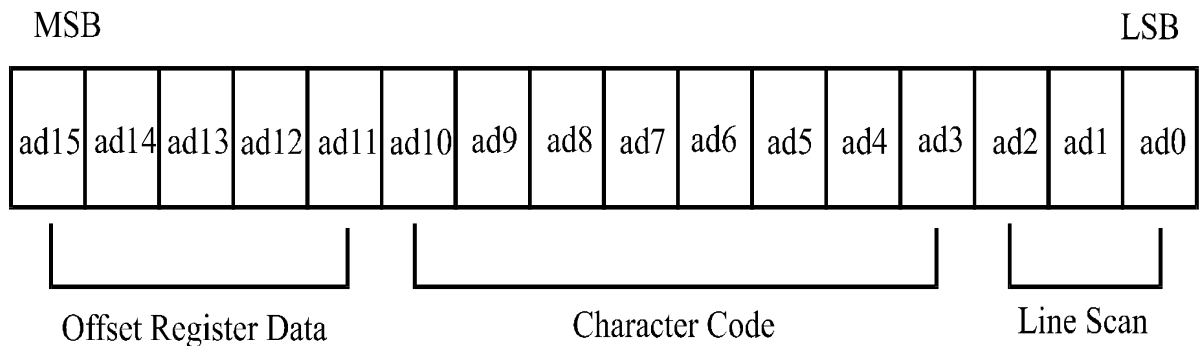

T6963C assign External character generator, when character code set 80H TO FFH in using internal character generator. Character code 00H to 80H assign External character generator, when External generator mode.









The senior five bits define the start address in external memory of the CG RAM area. The next eight bits represent the character code of the character. In internal CG ROM, character codes 00H to 7FH represent the predefined “internal” CG ROM characters, and codes 80H to FFH represent the user’s own “external” characters. In external CG ROM mode, all 256 codes from 00H to FFH can be used to represent the user’s own characters. The three least significant bits indicate one of the eight rows of eight dots that define the character’s shape.

The relationship between display RAM address and offset register

Offset register data	CG RAM hex. address (start to end)
00000	0000 to 07 FFH
00001	0800 to 0FFFH
00010	1000 to 17FFH
11100	E000 to E7FFH
11101	E800 to EFFFH
11110	F000 to F7FFH
11111	F800 to FFFFH

(Example 1)

Offset register 02H
 Character code 80H
 Character generator RAM start address 0001 0100 0000 0000
 1 4 0 0 H

	(address)	(data)
	1400H	00H
	1401H	1FH
	1402H	04H
	1403H	04H
	1404H	04H
	1405H	04H
	1406H	04H
	1407H	00H

(Example 2) The relationship between display RAM data and display characters

	(RAM DATA)	(Character)
AB γ DE ζ GHIJKLM	21H	A
⋮	22H	B
⋮	83H	γ
⋮	24H	D
⋮	25H	E
⋮	86H	ζ

Display character

γ and ζ are displayed by character generator RAM.

(3) Set Address Pointer

The Set Address Pointer command is used to indicate the start address for writing to (or reading from) external RAM.

The Flowchart for Set Address Pointer command

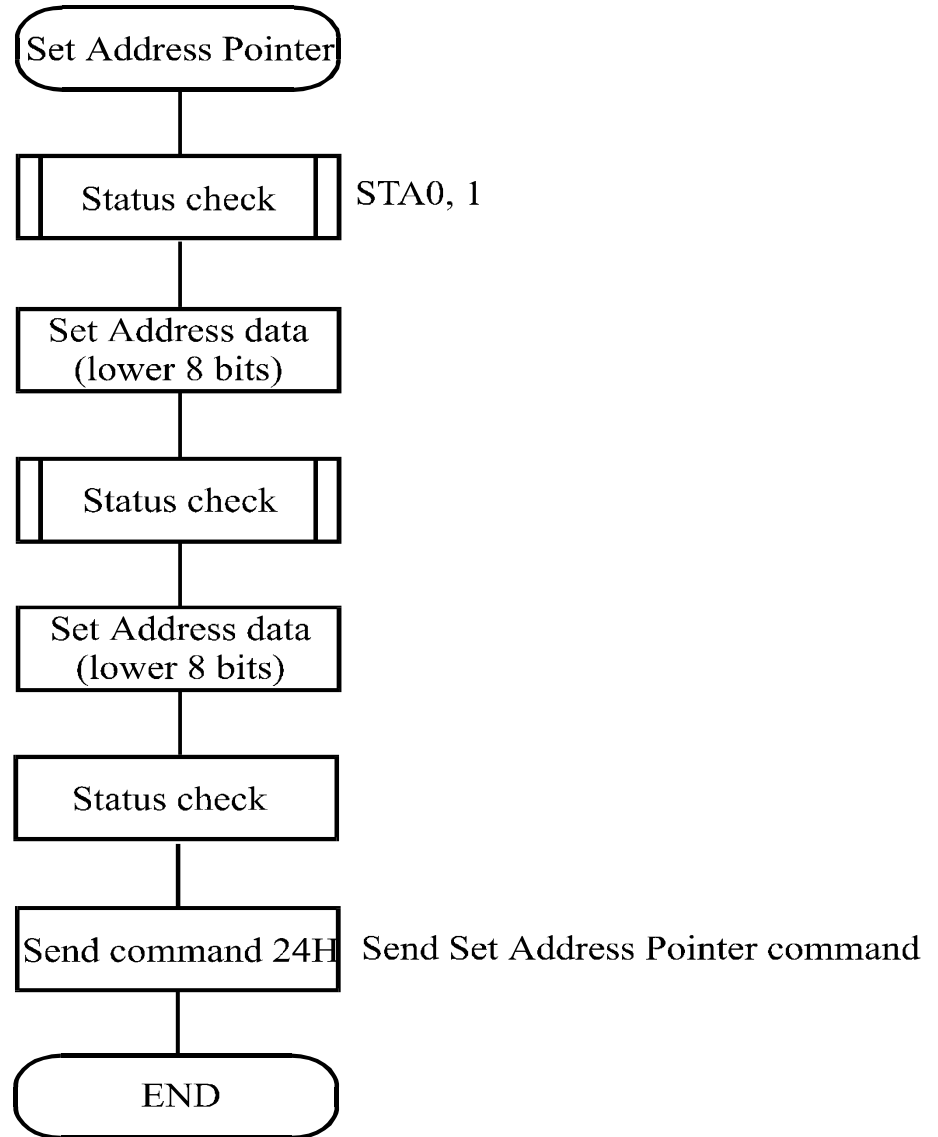

(3) Set Text Area

The display columns are defined by the hardware Setting. This command can be used to adjust the columns of the display.

(Example)

□ LCD size □ □ □ □ □ □ □ □ □ □ 20 columns, 4lines

□ Text home address □ □ □ □ □ □ □ 0000H

□ Text area □ □ □ □ □ □ □ □ □ □ 0014H

□ □ □ □ □ □ □ □ □ Set 32 columns, 4 Lines

0000	0001	0013	0014	001F
0014	0015	0027	0028	0033
0028	0029	003B	003C	0047
003C	003D	004F	0050	005B



(4) Set Graphic Area

The display columns are defined by the hardware setting. This command can be used to adjust the columns of the graphic display.

(Example)

□ LCD size □ □ □ □ □ □ □ □ □ □ 20 columns, 2lines

□ Graphic home address □ □ □ □ □ □ 0000H

□ Graphic are □ □ □ □ □ □ □ □ □ □ 0014H

0000	0001	0013	0014	001F
0014	0015	0027	0028	0033
0028	0029	003B	003C	0047
003C	003D	004F	0050	005B
0050	0051	0063	0064	006F
0064	0065	0077	0078	0083
0078	0079	008B	008C	0097
008C	008D	009F	00A0	00AB
00A0	00A1	00B3	00B4	00BF
00B4	00B5	00C7	00C8	00D3
00C8	00C9	00DB	00DC	00E7
00DC	00DD	00EF	00F0	00FD
00F0	00F1	0103	0104	011F
0104	0105	0127	0128	0123
0128	0129	013B	0013C	00147
013C	013D	014F	0150	015B

□ □ □ □ □ □

Set 32 columns, 2 Lines



If the graphic area setting is set to match the desired number of columns on the LCD, the addressing scheme will be automatically modified so that the start address of each line equals the end address of the previous line +1.

□ Mode set

CODE	FUNCTION	OPERAND
1000x000	OR Mode	□
1000x001	EXOR Mode	□
1000x011	AND Mode	□
1000x100	TEXT ATTRIBUTE Mode	□
10000xxx	Internal Character Generator Mode	□
10001xxx	External Character Generator Mode	□

X: invalid

The display mode is defined by this command. The display mode does not change until the next command is sent. The logical OR, EXOR, AND of text or graphic display can be displayed. In Internal Character Generator mode, character codes 00H to 7FH are assigned to the built-in character generator ROM. The character codes 80H to FFH are automatically assigned to the external character generator RAM.

(Example)

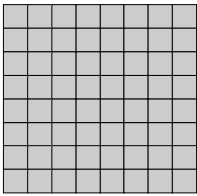

GRAPHIC

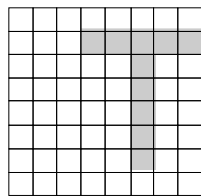

TEXT

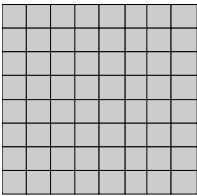

“OR”

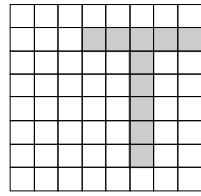

“AND”

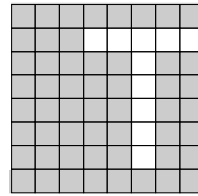

“TXOR”

(Note) Attribute functions can only be applied to text display, since the attribute data is placed in the graphic RAM area.

Attribute function

The attribute operations are Reverse display, Character blink and Inhibit. The attribute data is written into the graphic area which was defined by the Set Control Word command. Only text display is possible in Attribute Function mode; graphic display is automatically disabled. However, the Display Mode command must be used to turn both Text and Graphic on in order for the Attribute function to be available.

The attribute data for each character in the text area is written to the same address in the graphic area. The Attribute function is defined as follows.

Attribute RAM 1byte

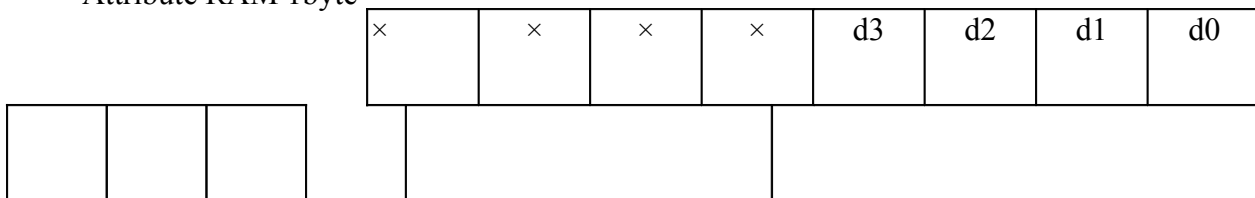

d3	d2	d1	d0	FUNCTION
0	0	0	0	Normal display
0	1	0	1	Reverse display
0	0	1	1	Inhibit display
1	0	0	0	Blink of normal display
1	1	0	1	Blink of reverse display
1	0	1	1	Blink of inhibit display

X: invalid

□ Display mode

CODE	FUNCTION	OPERAND
10010000	Display off	□
1001xx10	Cursor on, blink off	□
1001xx11	Cursor on, blink on	□
100101xx	Text on, graphic off	□
100110xx	Text off, graphic on	□
100111xx	Text on, graphic on	□

X:invalid

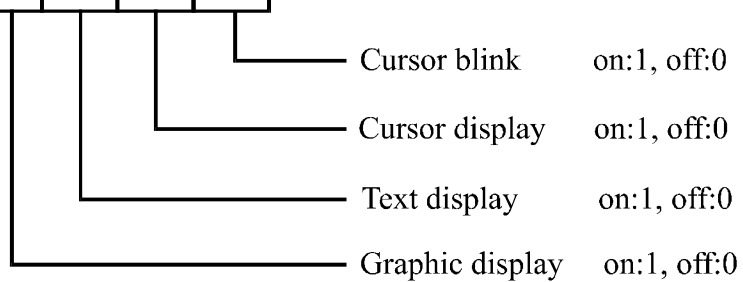
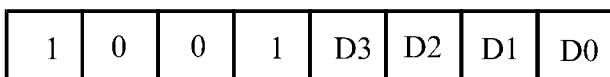

(Note) It is necessary to turn on “Text display” and “Graphic display” in the following cases.

- a) Combination of text/graphic display
- b) Attribute function

□ Cursor pattern select

CODE	FUNCTION	OPERAND
10100000	1-line cursor	□
10100001	2-line cursor	□
10100010	3-line cursor	□
10100011	4-line cursor	□
10100100	5-line cursor	□
10100101	6-line cursor	□
10100110	7-line cursor	□
10100111	8-line cursor	□

When cursor display is ON, this command selects the cursor pattern in the range 1 line to 8 lines. The cursor address is defined by the Cursor Pointer Set command.

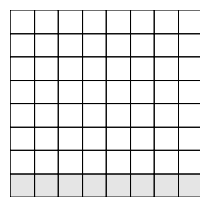

1-line cursor

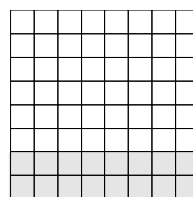

2-line cursor

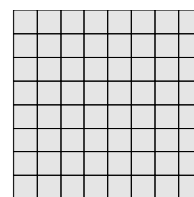

8-line cursor

□ Data Auto Read/Write

CODE	HEX.	FUNCTION	OPERAND
10110000	B0H	Set Data Auto Write	□
10110001	B1H	Set Data Auto Read	□
10110010	B2H	Auto Reset	□

The command is convenient for sending a full screen of data from the external display RAM. After setting Auto mode, a Data Write (or Read) command is need not be sent between each datum. A Data Auto Write (or Read) command must be sent after a Set Address Pointer command. After this command, the address pointer is automatically incremented by 1 after each datum. In Auto mode, the T6963C cannot accept any other commands.

The Auto Reset command must be sent to the T69963C after all data has been sent, to clear Auto mode.

(Note) A Status check for Auto mode

(STA2, STA3 should be checked between sending of each datum. Auto Reset should be performed after checking STA3=1 (STA2=1.) Refer to the following flowchart.

a) Auto Read mode

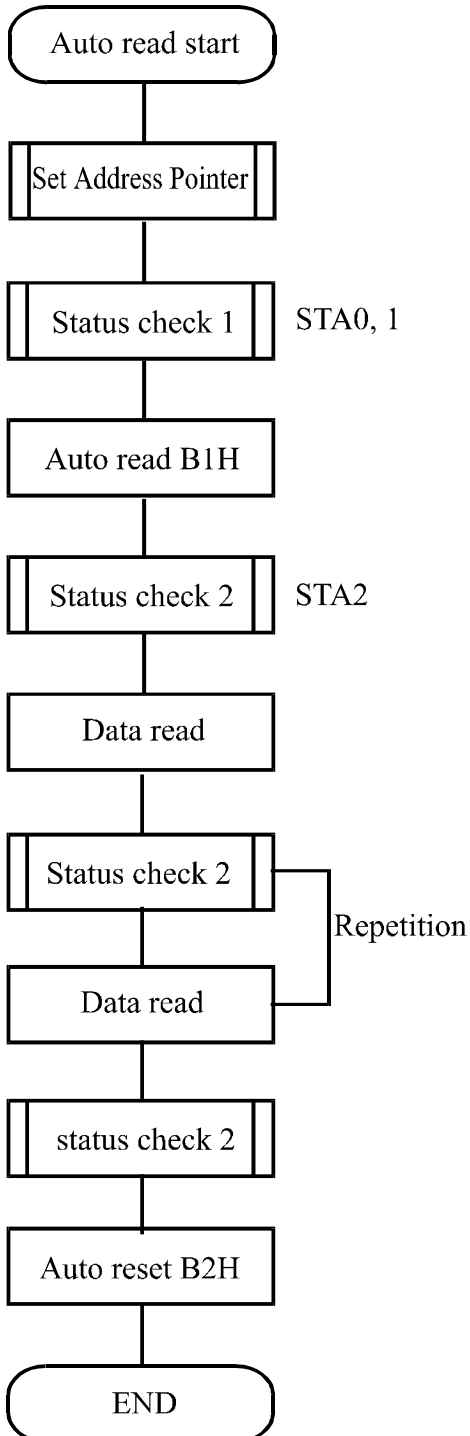

b) Auto Write mode

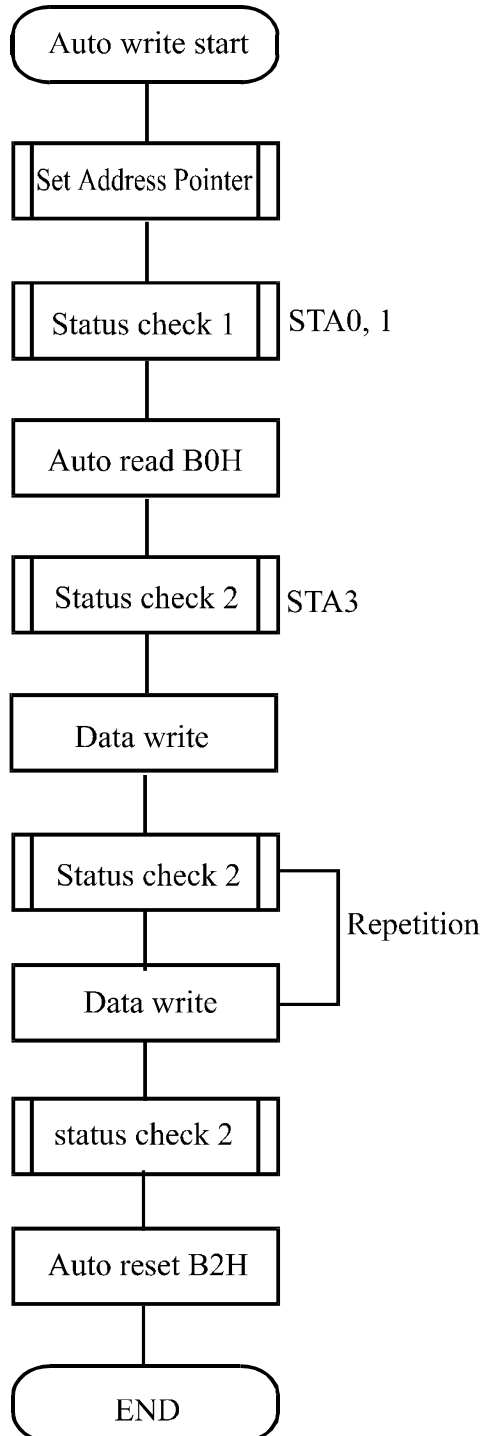

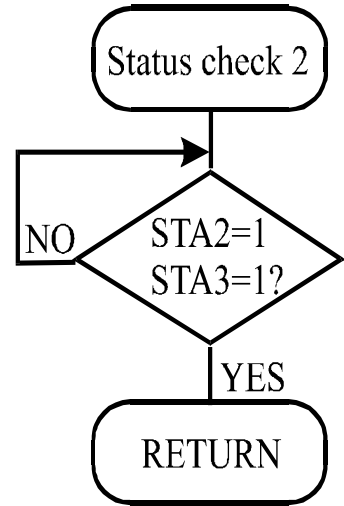
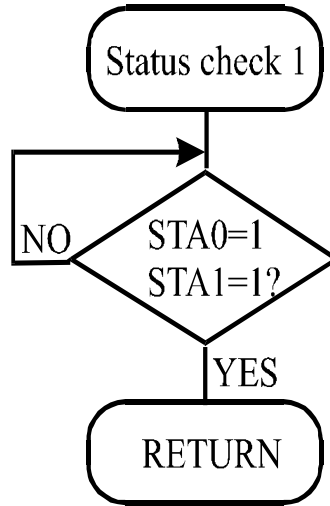
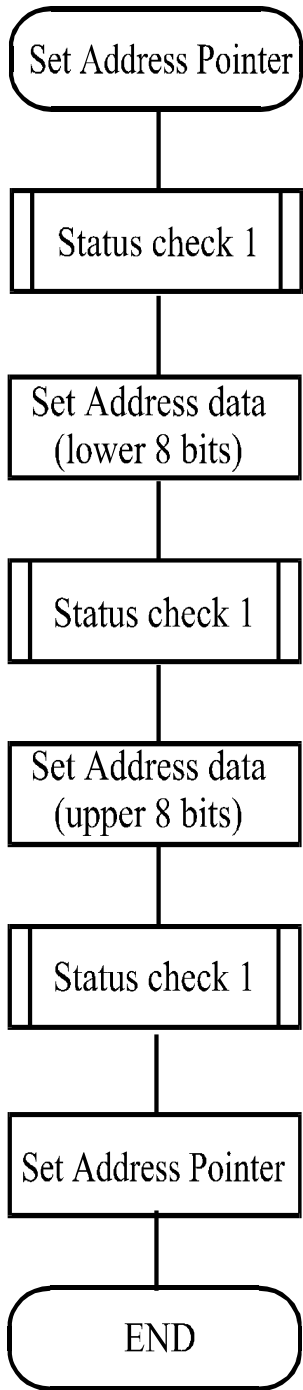

□ Date Read/Write

CODE	HEX.	FUNCTION	OPERAND
11000000	C0H	Data Write and Increment ADP	Data
11000001	C1H	Data Read and Increment ADP	□
11000010	C2H	Data Write and Decrement ADP	Data
11000011	C3H	Data Read and Decrement ADP	□
11000100	C4H	Data Write and Nonvariable ADP	Data
11000101	C5H	Data Read and Nonvariable ADP	□

This command is used for writing data from the MPU to external display RAM, and reading data from external display RAM to the MPU. Data Write/Data Read should be executed after setting address using Set Address Pointer command. The address pointer can be automatically incremented or decremented using this command.

(Note) This command is necessary for each 1-byte datum.

Refer to the following flowchart.

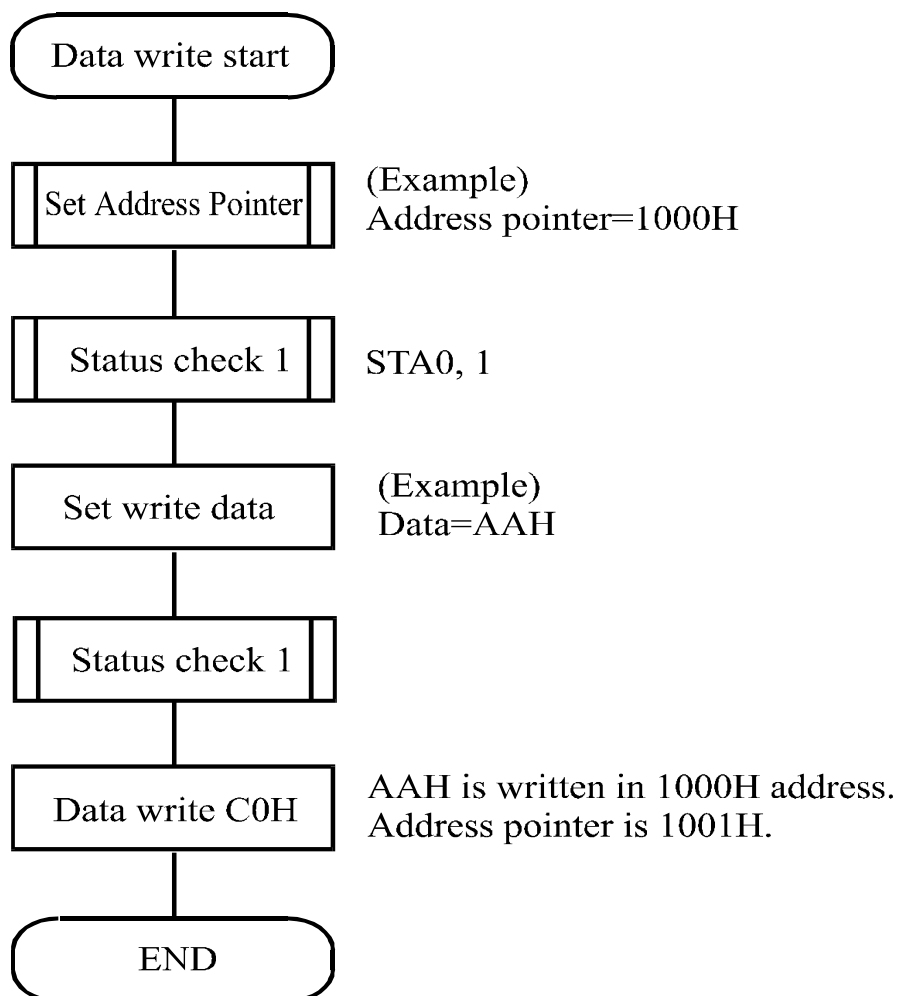

□ Screen Peek

CODE	HEX.	FUNCTION	OPERAND
11100000	E0H	Screen Peek	0e

This command is used to transfer 1 byte of displayed data to the data stack; this byte can then be read from the MPU by data access. The logical combination of text and graphic display data on the LCD screen can be read by this command.

The status (STA6) should be checked just after the Screen Peek command. If the address determined by the Set Address Pointer command is not in the graphic area, this command is ignored and a status flag (STA6) is set.

Refer to the following flowchart.

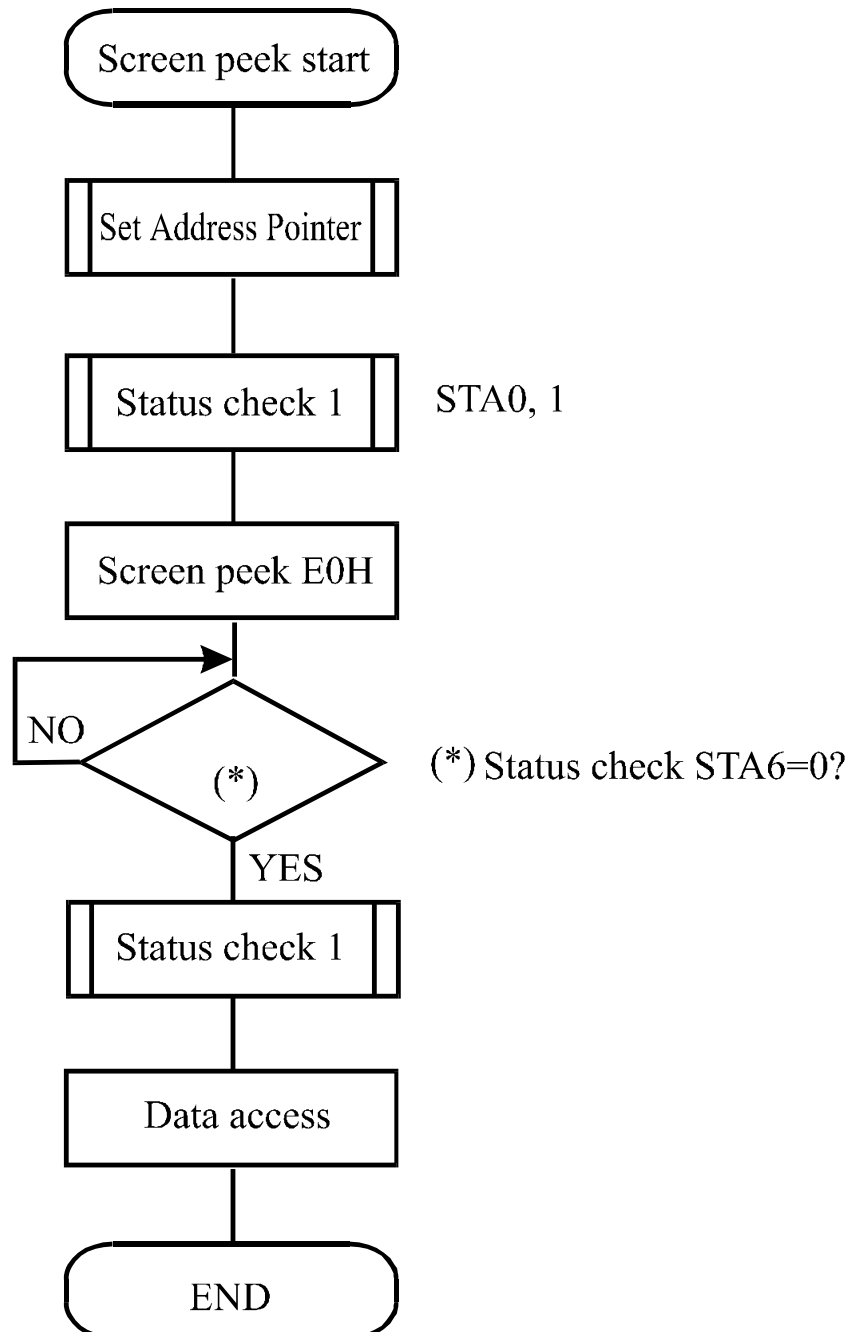

□ Screen Copy

CODE	HEX.	FUNCTION	OPERAND
11101000	E8H	Screen Copy	□

This command copies a single raster line of data to the graphic area.

The start point must be set using the Set Address Pointer command.

(Note 1) □ If the attribute function is being used, this command is not available.

□ □ □ □ (With Attribute data is graphic area data.)

Refer to the following flowchart.

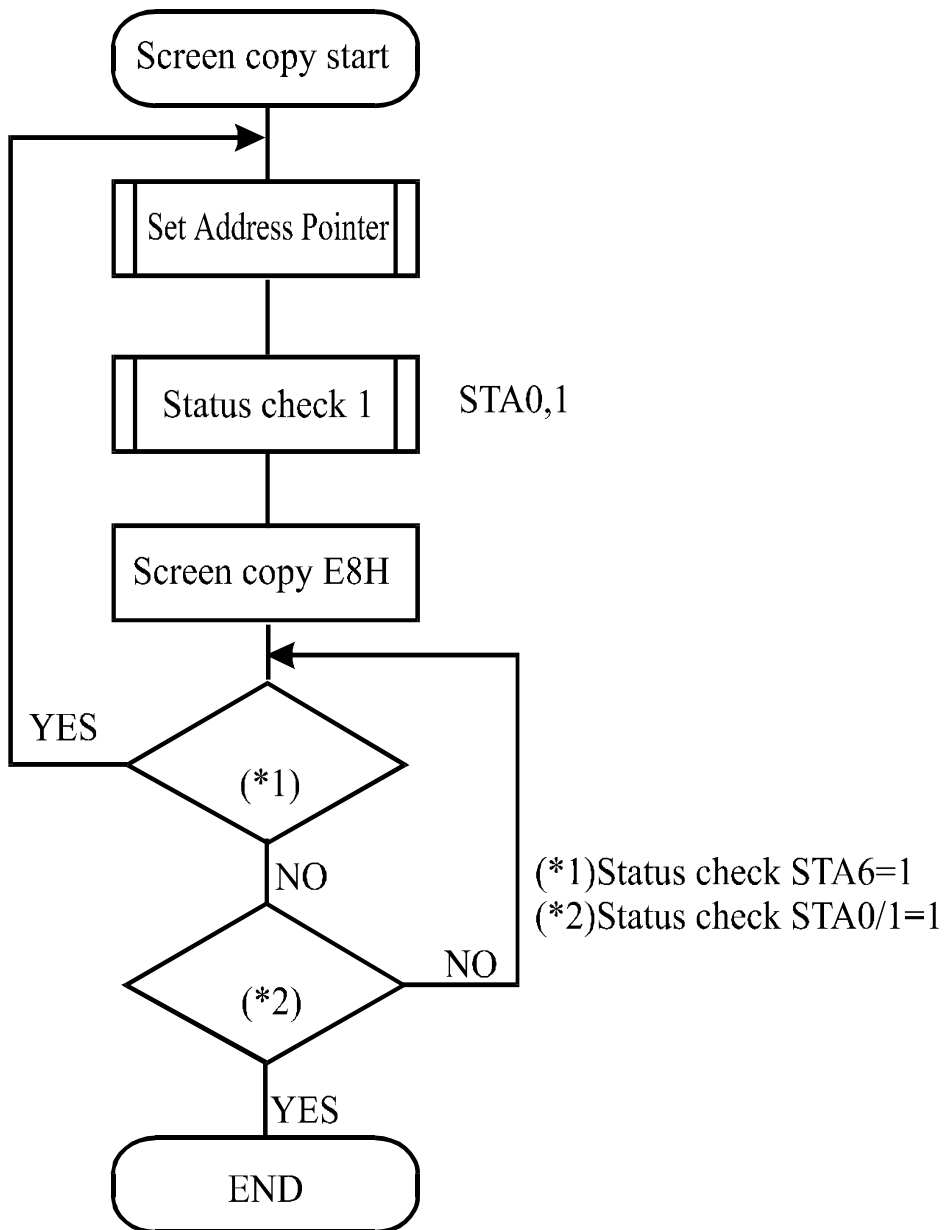

□ Bit Set/Reset

CODE	FUNCTION	OPERAND
11110xxx	Bit Reset	□
11111xxx	Bit Set	□
1111x000	Bit 0 (LSB)	□
1111x001	Bit 1	□
1111x010	Bit 2	□
1111x011	Bit 3	□
1111x100	Bit 4	□
1111x101	Bit 5	□
1111x110	Bit 6	□
1111x111	Bit 7 (MSB)	□

X: invalid

This command use to set or reset a bit of the byte specified by the address pointer.

Only one bit can be set/reset at a time.

Refer to the following flowchart.

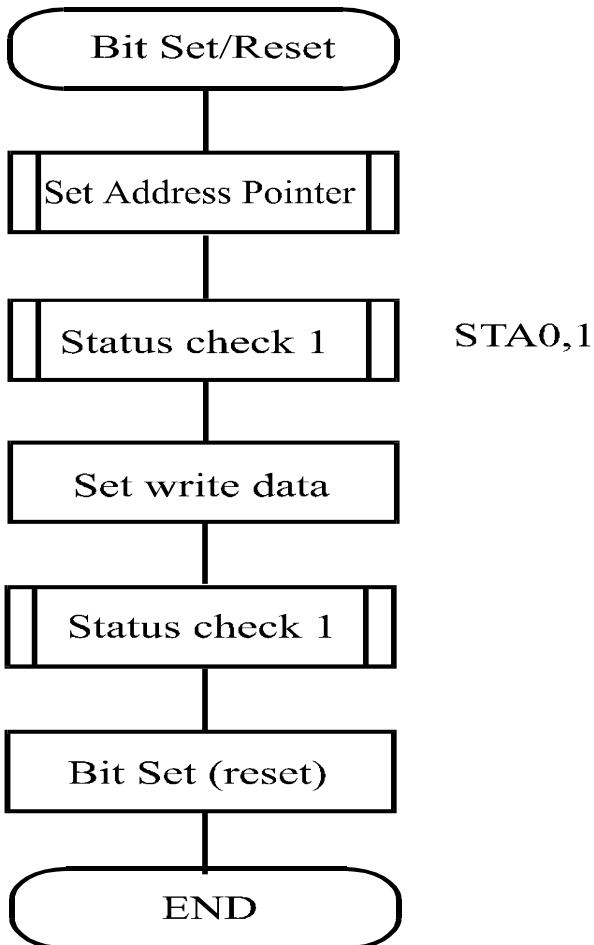

Upper 4 bit Lower 4 bit	LLLL	LLLH	LLHL	LLHH	LHLL	LHLH	LHHL	LHHH
LLLL		0	1	2	3	4	5	6
LLLH	7	8	9	A	B	C	D	E
LLHL	F	10	11	12	13	14	15	16
LLHH	17	18	19	1A	1B	1C	1D	1E
LHLL	1F	20	21	22	23	24	25	26
LHLH	27	28	29	2A	2B	2C	2D	2E
LHHL	2F	30	31	32	33	34	35	36
LHHH	37	38	39	3A	3B	3C	3D	3E
HLLL	3F	40	41	42	43	44	45	46
HLLH	47	48	49	4A	4B	4C	4D	4E
HLHL	4F	50	51	52	53	54	55	56
HLHH	57	58	59	5A	5B	5C	5D	5E
HHLL	5F	60	61	62	63	64	65	66
HHLH	67	68	69	6A	6B	6C	6D	6E
HHHL	6F	70	71	72	73	74	75	76
HHHH	77	78	79	7A	7B	7C	7D	7E

10. Timing Characteristics

Bus Timing

($V_{SS} = 0\text{ V}$, $V_{DD} = 5\text{ V}$)

Item	Symbol	Min	Typ	Max	Unit
C/D Set-up Time	t_{CDS}	100	□	□	ns
C/D Hold Time	t_{CDH}	10	□	□	ns
CE, RD, WR Pulse Width	t_{CDS} , t_{RD} , t_{WR}	80	□	□	ns
Data Set-up Time	t_{DS}	80	□	□	ns
Data Hold Time	t_{DH}	40	□	□	ns
Access Time	t_{ACC}	□	□	150	ns
Output Hold Time	t_{OH}	10	□	50	ns

11. Reliability

Content of Reliability Test (wide temperature, -20°C~70°C)

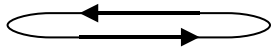
Environmental Test			
Test Item	Content of Test	Test Condition	Note
High Temperature storage	Endurance test applying the high storage temperature for a long time.	80°C 200hrs	2
Low Temperature storage	Endurance test applying the high storage temperature for a long time.	-30°C 200hrs	1,2
High Temperature Operation	Endurance test applying the electric stress (Voltage & Current) and the thermal stress to the element for a long time.	70°C 200hrs	—
Low Temperature Operation	Endurance test applying the electric stress under low temperature for a long time.	-20°C 200hrs	1
High Temperature/ Humidity Operation	The module should be allowed to stand at 60□,90%RH max For 96hrs under no-load condition excluding the polarizer, Then taking it out and drying it at normal temperature.	60°C,90%RH 96hrs	1,2
Thermal shock resistance	The sample should be allowed stand the following 10 cycles of operation -20°C 25°C 70°C  30min 5min 30min 1 cycle	-20°C/70°C 10 cycles	—
Vibration test	Endurance test applying the vibration during transportation and using.	Total fixed amplitude : 1.5mm Vibration Frequency : 10~55Hz One cycle 60 seconds to 3 directions of X,Y,Z for Each 15 minutes	3
Static electricity test	Endurance test applying the electric stress to the terminal.	VS=800V,RS=1.5kΩ CS=100pF 1 time	—

Note1: No dew condensation to be observed.

Note2: The function test shall be conducted after 4 hours storage at the normal Temperature and humidity after remove from the test chamber.

Note3: Vibration test will be conducted to the product itself without putting it in a container.

12. Touch panel Information

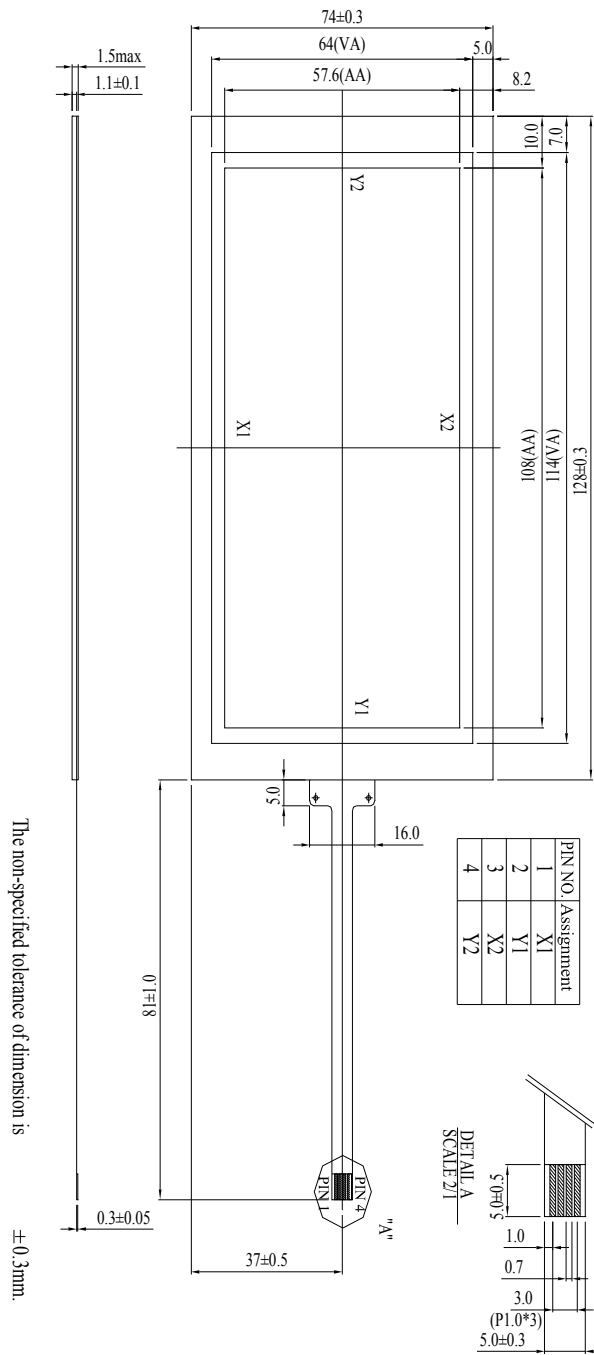

ELECTRICAL SPECIFICATIONS

ITEM	SPECIFICATION	CONDITION
ON RESISTANCE	250Ω ~ 750Ω	DIRECTION:X
	250Ω ~ 800Ω	DIRECTION:Y
INSULATION RESISTANCE	MORE THAN 20MΩ	DC 25V
CHATTERING TIME	LESS THAN 10 msec	100KΩ PULL-UP
LINEARITY	±1.0%	X AXIS
	±1.0%	Y AXIS

MACHINE SPECIFICATIONS

ITEM	SPECIFICATION	CONDITION
OPERATING FORCE	LESS THAN 80g	R8.0 HS 40 ° SILICON RUBBER OR R0.8 POLYACETAL PEN
SURFACE HARDNESS	MORE THAN 2H	PENCIL TEST
LIGHT TRANSMISSION	MORE THAN 80 %	@550nm HITACHI U3300
DURABILITY FOR PEN SELECTIONS	MORE THAN 1,200,000 TIMES	FORCE:250g SPEED:2cm/sec

13. Backlight Information

Specification

PARAMETER	SYMBOL	MIN	TYP	MAX	UNIT	TEST CONDITION
Supply Current	I _{LED}	140	180	270	mA	V=3.5V
Supply Voltage	V	3.4	3.5	3.6	V	□
Reverse Voltage	V _R	□	□	5	V	□
Luminous Intensity	I _V	160	170	□	CD/M ²	I _{LED} =180mA
Life Time	□	□	10K	□	Hr.	I _{LED} =180mA
Color	White					

Note: The LED of B/L is drive by current only, drive voltage is for reference only. drive voltage can make driving current under safety area (current between minimum and maximum).

Backlight connector is JST XHP-3. Please see appendix for details.

LED B\L Drive Method

1. Drive from A , K

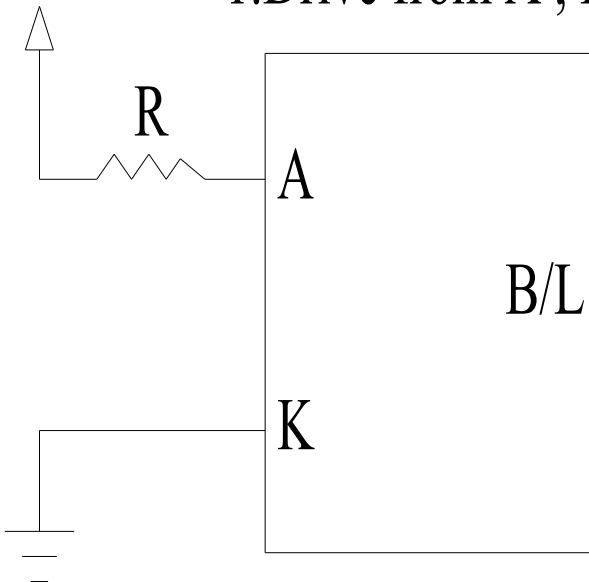

14.13. Material List of Components for RoHS

1. Crystalfontz America, Inc. hereby declares that all of or part of products (with the mark “#”in code), including, but not limited to, the LCM, accessories or packages, manufactured and/or delivered to your company (including your subsidiaries and affiliated company) directly or indirectly by our company (including our subsidiaries or affiliated companies) do not intentionally contain any of the substances listed in all applicable EU directives and regulations, including the following substances.

Exhibit A:The Harmful Material List

Material	(Cd)	(Pb)	(Hg)	(Cr6+)	PBBs	PBDEs
Limited Value	100 ppm	1000 ppm	1000 ppm	1000 ppm	1000 ppm	1000 ppm
Above limited value is set up according to RoHS.						

2.Process for RoHS requirement:

(1) Use the Sn/Ag/Cu soldering surface □ the surface of Pb-free solder is rougher than we used before.

(2) Heat-resistance temp.

Reflow: 250°C,30 seconds Max.

Connector soldering wave or hand soldering: 320°C, 10 seconds max.

(3) Temp. curve of reflow, max. Temp.: 235±5°C

Recommended customer’s soldering temp. of connector: 280°C, 3 seconds.

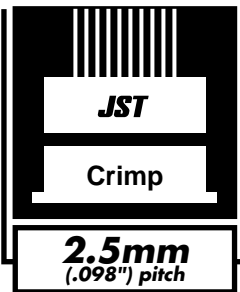

Crystalfontz America, Inc.

This is the JST data sheet for the module's backlight connector. The connector and its mating parts are highlighted in yellow.

XH CONNECTOR

Disconnectable Crimp style connectors

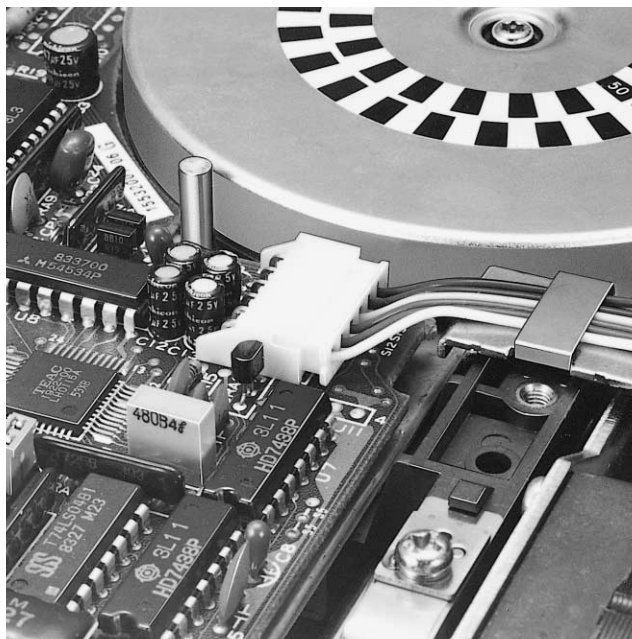
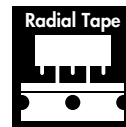

The XH connector was developed based on the high reliability and versatility of our NH series connectors. The connector is very small with a mounting height of 9.8mm (.386"). Yet it meets the needs for high-density mounting and miniaturization of electronic equipment, including VCRs, radio-cassette players, and car stereo systems.

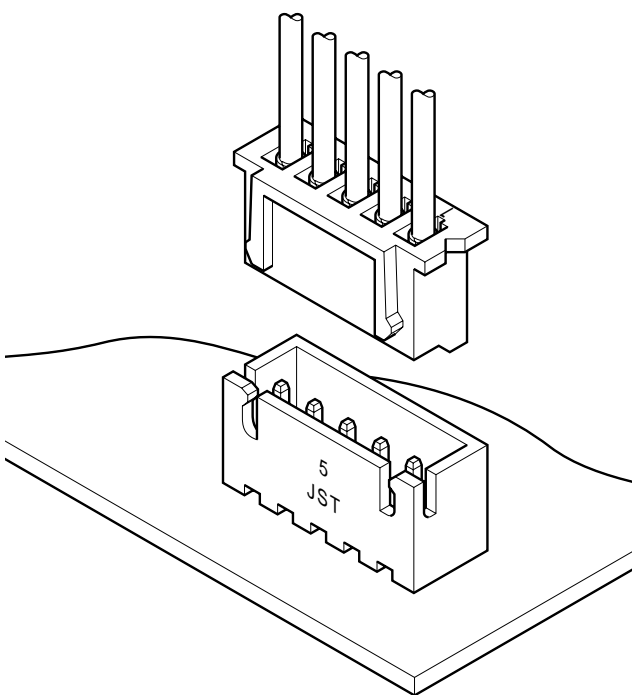

Features

• Original folded beam contact

The protected, folded beam contact in this connector provides high contact pressure with an over-stress stop feature. This ensures dependable continuity when used with low voltage, low current carrying circuits (dry circuits). The wire crimp section is mechanically decoupled from the post insertion section which, in turn, prevents the mating area from being adversely affected by crimping.

• Box-shaped shrouded header

The four-sided, box-shaped shroud prevents the receptacle from being misinserted or pried during insertion and removal. The shroud also prevents foreign matter from reaching the posts and resists contact deformation due to handling and shipping. Furthermore, a serrated, oversized square post is pressure-fit into each square hole to completely protect the post against heat and to prevent flux from entering during dip soldering.

• Header with a boss

This header has a boss (projection) on the bottom of the housing to prevent improper insertion in printed circuit boards.

• Interchangeability

This header is interchangeable with those of 2.5mm (.098") pitch insulation displacement NR and NRD connectors and board-to-board JQ connectors.

• Conforming to the HA terminal

The 4-circuit XH connector conforms to the HA terminal specified in JEM 1427 (Japanese Electric Machine Industry Association Standards).

Specifications

- Current rating: 3A AC, DC (AWG#22)
- Voltage rating: 250V AC, DC
- Temperature range: -25°C to +85°C
(including temperature rise in applying electrical current)
- Contact resistance: Initial value/10m Ω max.
After environmental testing/20m Ω max.
- Insulation resistance: 1,000M Ω min.
- Withstanding voltage: 1,000V AC/minute
- Applicable wire: AWG #30 to #22
- Applicable PC board thickness: 1.6mm(.063")
- * Contact JST if Lead-Free product is required.
- * Refer to "General Instruction and Notice when using Terminals and Connectors" at the end of this catalog.
- * Contact JST for details.

Standards

Recognized E60389

Certified LR20812

J50014297

XH CONNECTOR

Contact

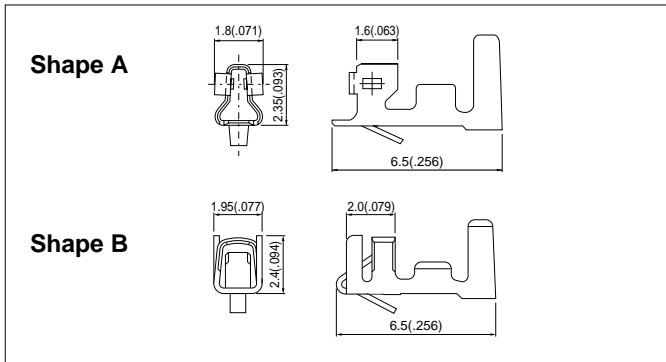

Model No.	Shape	Applicable Wire			Q'ty / reel
		mm ²	AWG#	Insulation O.D mm(in.)	
SXH-001T-P0.6N	A	0.13 to 0.33	26 to 22	1.3 to 1.9(.051 to .075)	5,000
SXH-001T-P0.6	B	0.08 to 0.33	28 to 22	1.2 to 1.9(.047 to .075)	8,000
SXH-002T-P0.6		0.05 to 0.13	30 to 26	0.9 to 1.3(.035 to .051)	

Material and Finish

Phosphor bronze, tin-plated

Note:

- Contact JST if you require gold-plated contacts or contacts made of brass.
- Contact JST also if you require shielded wires, thin wires or other special wires.
- SXH-001T-P0.6N is low-insertion force type contact, for easier insertion/withdrawal, which would be less resistant to the vibration.

Housing

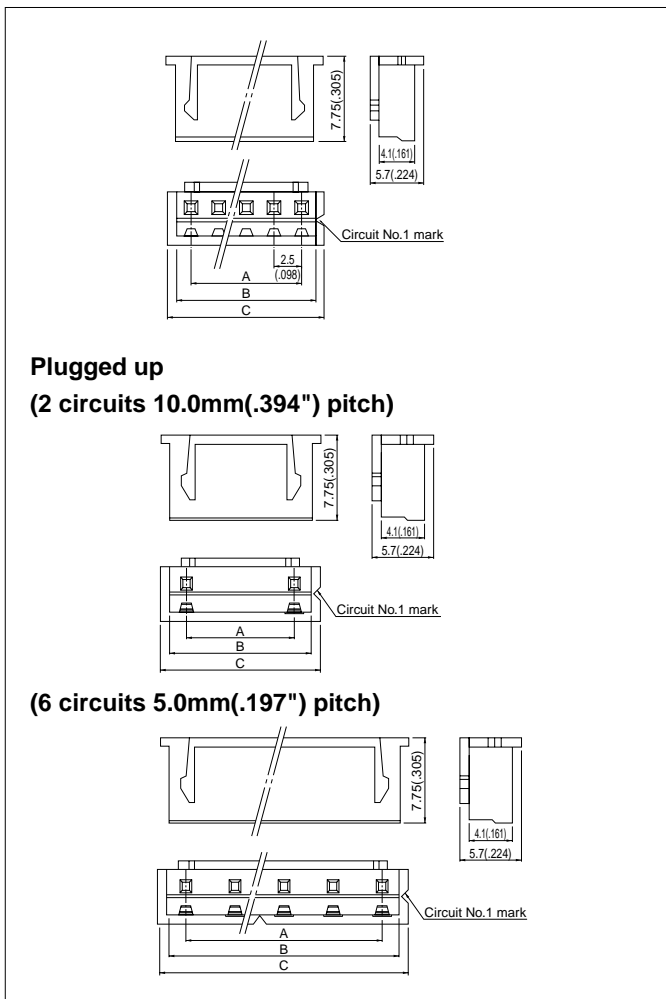

Circuits	Model No.	Dimensions mm(in.)			Q'ty / bag
		A	B	C	
1	XHP- 1	—	3.2(.126)	4.8(.189)	1,000
2	XHP- 2	2.5(.098)	5.7(.224)	7.3(.287)	1,000
2	XHP- 2(10.0)-U	10.0(.394)	13.2(.520)	14.8(.583)	1,000
3	XHP- 3	5.0(.197)	8.2(.323)	9.8(.386)	1,000
4	XHP- 4	7.5(.295)	10.7(.421)	12.3(.484)	1,000
5	XHP- 5	10.0(.394)	13.2(.520)	14.8(.583)	1,000
6	XHP- 6	12.5(.492)	15.7(.618)	17.3(.681)	1,000
6	XHP- 6(5.0)-U	25.0(.984)	28.2(1.110)	29.8(1.173)	1,000
7	XHP- 7	15.0(.591)	18.2(.717)	19.8(.780)	1,000
8	XHP- 8	17.5(.689)	20.7(.815)	22.3(.878)	1,000
9	XHP- 9	20.0(.787)	23.2(.913)	24.8(.976)	1,000
10	XHP-10	22.5(.886)	25.7(1.012)	27.3(1.075)	1,000
11	XHP-11	25.0(.984)	28.2(1.110)	29.8(1.173)	1,000
12	XHP-12	27.5(1.083)	30.7(1.209)	32.3(1.272)	1,000
13	XHP-13	30.0(1.181)	33.2(1.307)	34.8(1.370)	1,000
14	XHP-14	32.5(1.280)	35.7(1.406)	37.3(1.469)	1,000
15	XHP-15	35.0(1.378)	38.2(1.504)	39.8(1.567)	1,000
16	XHP-16	37.5(1.476)	40.7(1.602)	42.3(1.665)	1,000
20	XHP-20	47.5(1.870)	50.7(1.996)	52.3(2.059)	500

Material

Nylon 6, UL94V-0, natural (white)

Note:

- XHP-2(10.0)-U is 2 circuits 10.0mm(.394") pitch plugged up. Not UL/CSA/TUV approved.
- XHP-6(5.0)-U is 6 circuits 5.0mm(.197") pitch plugged up. Not UL/CSA/TUV approved.

<For reference> As the color identification, the following alphabet shall be put in the underlined part. For availability, delivery and minimum order quantity, contact JST.

ex. **XHP-1-oo**
(blank)...natural (white)
BK...black R...red E...blue Y...yellow L...lemon yellow
M...green D...orange N...brown FY...vivid yellow

<Plugged up type>

ex. **XHP-2(10.0)-U-oo**
(blank)...natural (white)
R...red E...blue

Through-hole type shrouded header

The shrouded headers are interchangeable with those of the BR, NR and NRD insulation displacement connectors, and JQ board-to-board connectors.

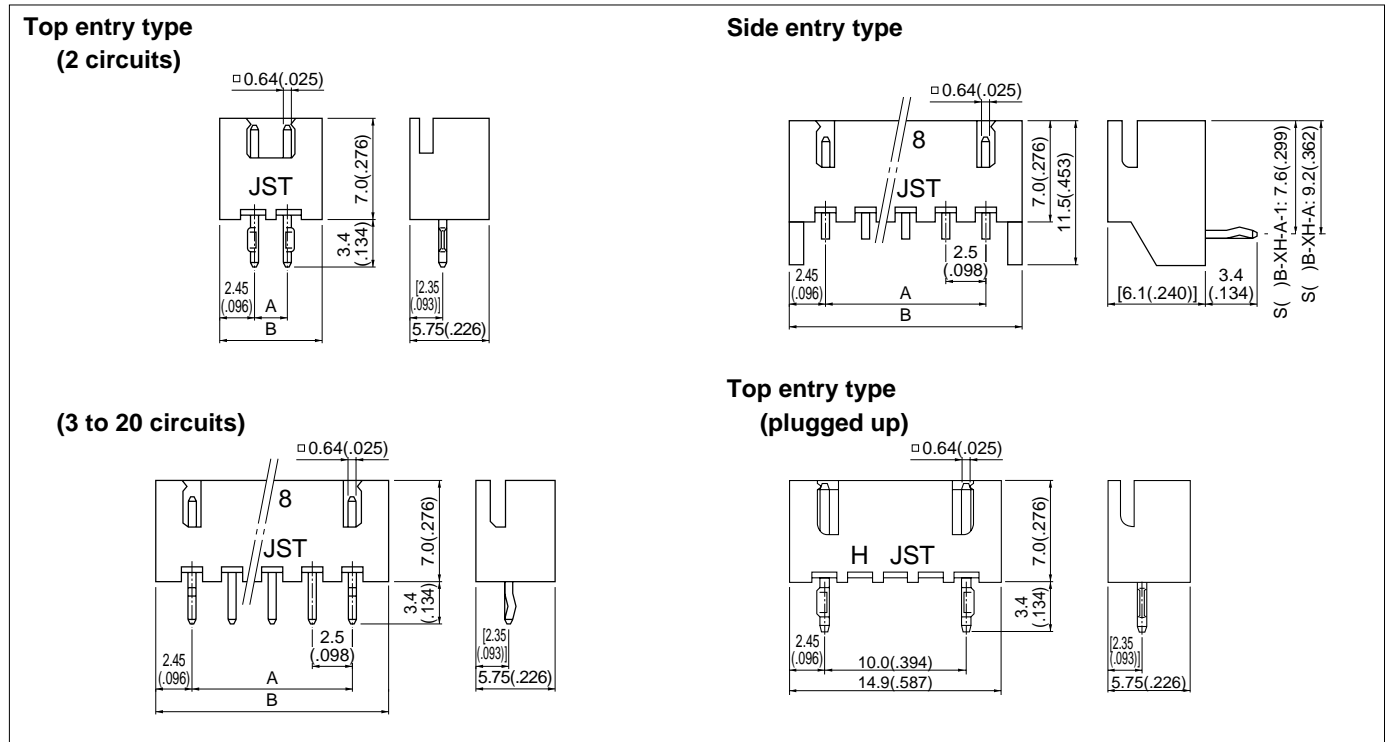

Circuits	Model No.		Dimensions mm(in.)		Q'ty / box	
	Top entry type	Side entry type	A	B	Top entry type	Side entry type
2	B 2B-XH-A	—	2.5(.098)	7.4(.291)	1,000	1,000
2	B2 (10.0)B-XH-A-U	—	10.0(.394)	14.9(.587)	1,000	1,000
3	B 3B-XH-A	S 3B-XH-A-1	5.0(.197)	9.9(.390)	1,000	1,000
4	B 4B-XH-A	S 4B-XH-A-1	7.5(.295)	12.4(.488)	500	500
5	B 5B-XH-A	S 5B-XH-A-1	10.0(.394)	14.9(.587)	500	500
6	B 6B-XH-A	S 6B-XH-A-1	12.5(.492)	17.4(.685)	500	500
7	B 7B-XH-A	S 7B-XH-A-1	15.0(.591)	19.9(.783)	500	250
8	B 8B-XH-A	S 8B-XH-A-1	17.5(.689)	22.4(.882)	500	250
9	B 9B-XH-A	S 9B-XH-A-1	20.0(.787)	24.9(.980)	500	250
10	B10B-XH-A	S10B-XH-A-1	22.5(.886)	27.4(1.079)	250	250
11	B11B-XH-A	S11B-XH-A-1	25.0(.984)	29.9(1.177)	250	250
12	B12B-XH-A	S12B-XH-A-1	27.5(1.083)	32.4(1.276)	250	200
13	B13B-XH-A	S13B-XH-A-1	30.0(1.181)	34.9(1.374)	250	200
14	B14B-XH-A	S14B-XH-A-1	32.5(1.280)	37.4(1.472)	250	200
15	B15B-XH-A	S15B-XH-A-1	35.0(1.378)	39.9(1.571)	250	100
16	B16B-XH-A	—	37.5(1.476)	42.4(1.669)	200	100
20	B20B-XH-A	—	47.5(1.870)	52.4(2.063)	100	—

Material and Finish

Post: Brass, copper-undercoated, tin/lead-plated
Wafer: Nylon 66, UL94V-0, natural (white)

Note: B2(10.0)B-XH-A-U is 2 circuits 10.0mm(.394") pitch plugged up. Not UL/CSA/TÜV approved.

<For reference> As the color identification, the following alphabet shall be put in the underlined part. For availability, delivery and minimum order quantity, contact JST.

ex. **S3B-XH-A(1)-oo**

(blank)...natural (white)

BK...black R...red E...blue Y...yellow L...lemon yellow M...green D...orange N...brown FY...vivid yellow

XH CONNECTOR

Through-hole type shrouded header

Top entry type of glass-filled nylon

(2 circuits)

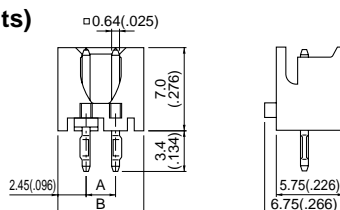

(3 to 8 circuits)

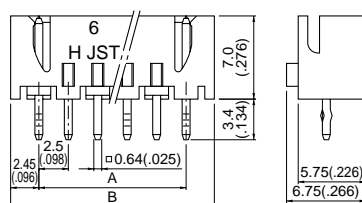

(9 to 15 circuits)

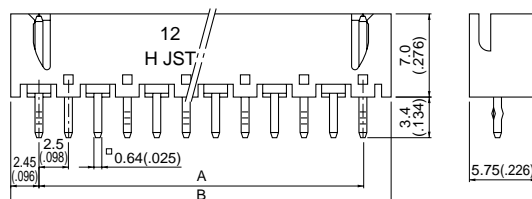

Circuits	Model No.	Dimensions mm(in.)		Q'ty / box
		A	B	
2	B 2B-XH-2	2.5(.098)	7.4(.291)	1,000
3	B 3B-XH-2	5.0(.197)	9.9(.390)	1,000
4	B 4B-XH-2	7.5(.295)	12.4(.488)	500
5	B 5B-XH-2	10.0(.394)	14.9(.587)	500
6	B 6B-XH-2	12.5(.492)	17.4(.685)	500
7	B 7B-XH-2	15.0(.591)	19.9(.783)	500
8	B 8B-XH-2	17.5(.689)	22.4(.882)	250
9	B 9B-XH-2	20.0(.787)	24.9(.980)	250
10	B10B-XH-2	22.5(.886)	27.4(1.079)	250
11	B11B-XH-2	25.0(.984)	29.9(1.177)	250
12	B12B-XH-2	27.5(1.083)	32.4(1.276)	250
13	B13B-XH-2	30.0(1.181)	34.9(1.374)	250
14	B14B-XH-2	32.5(1.280)	37.4(1.472)	250
15	B15B-XH-2	35.0(1.378)	39.9(1.571)	250

Material and Finish

Post: Brass, copper-undercoated, tin/lead-plated
 Wafer: Glass-filled nylon 66, UL94V-0, natural (ivory)

<For reference> As the color identification,
 the following alphabet shall be put in the underlined part.
 For availability, delivery and minimum order quantity, contact JST.

ex. **B2B-XH-2-oo**

(blank)...natural (ivory)

C...black R...red E...blue Y...yellow M...green

Through-hole type shrouded header

The shrouded headers are interchangeable with those of the NR, NRD and BR insulation displacement connectors, and JQ board-to-board connectors.

Top entry type with a boss

(1 circuit)

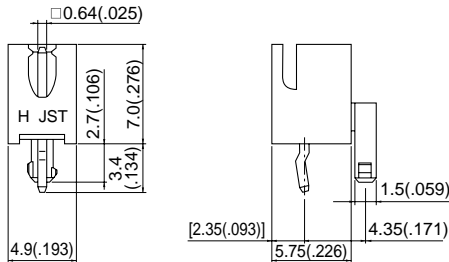

(2 circuits)

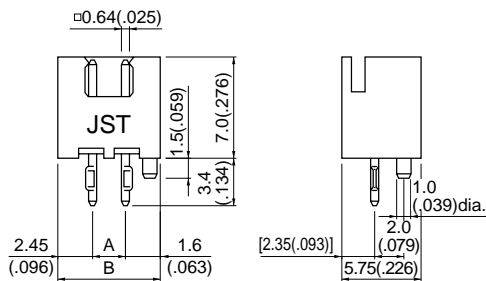

(3 to 12 circuits)

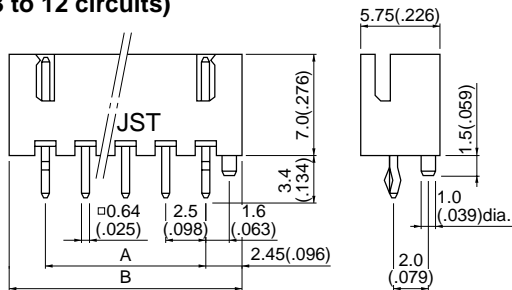

Circuits	Model No.	Dimensions mm(in.)		Q'ty / box
		A	B	
1	B 1B-XH-AM	—	—	1,000
2	B 2B-XH-AM	2.5(.098)	7.4(.291)	1,000
3	B 3B-XH-AM	5.0(.197)	9.9(.390)	1,000
4	B 4B-XH-AM	7.5(.295)	12.4(.488)	500
5	B 5B-XH-AM	10.0(.394)	14.9(.587)	500
6	B 6B-XH-AM	12.5(.492)	17.4(.685)	500
7	B 7B-XH-AM	15.0(.591)	19.9(.783)	500
8	B 8B-XH-AM	17.5(.689)	22.4(.882)	250
9	B 9B-XH-AM	20.0(.787)	24.9(.980)	250
10	B10B-XH-AM	22.5(.886)	27.4(1.079)	250
12	B12B-XH-AM	27.5(1.083)	32.4(1.276)	250

Material and Finish

Post: Brass, copper-undercoated, tin/lead-plated
Wafer: Nylon 66, UL94V-0, natural (white)

Note: B1B-XH-AM is not UL/CSA/TÜV approved.

<For reference> As the color identification, the following alphabet shall be put in the underlined part. For availability, delivery and minimum order quantity, contact JST.

ex. **B1B-XH-AM-oo**

(blank)...natural (white)

BK...black R...red E...blue Y...yellow L...lemon yellow

M...green

XH CONNECTOR

Through-hole type shrouded header on radial-tape

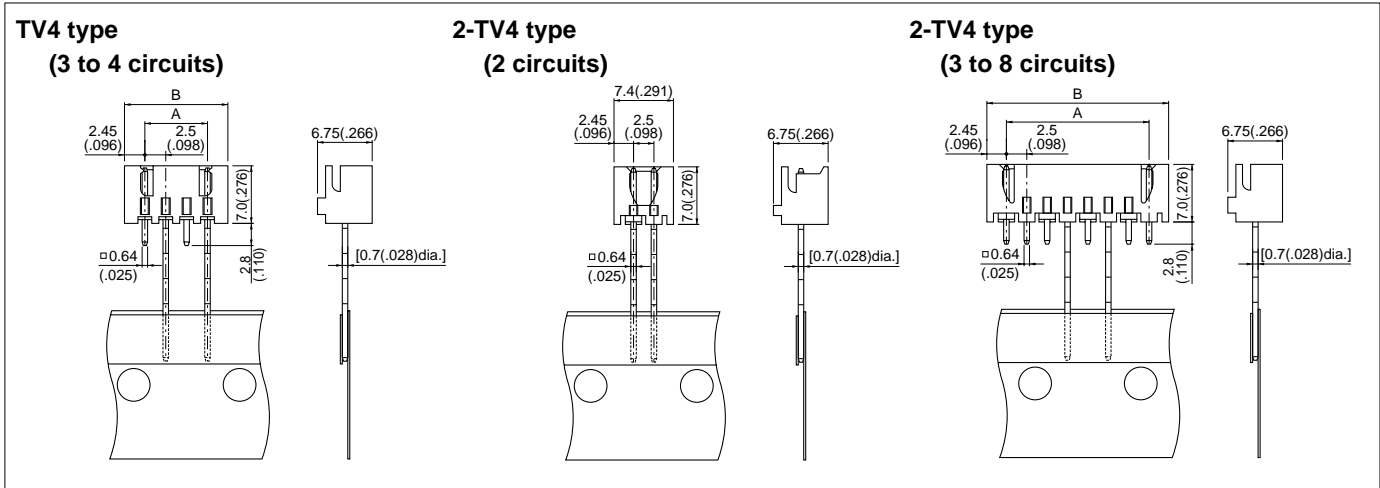

Circuits	Model No.		Dimensions mm(in.)		Q'ty / box
	A	B	A	B	
2	—	B2B-XH-2-TV4	—	—	1,000
3	B3B-XH-TV4	B3B-XH-2-TV4	5.0(.197)	9.9(.390)	1,000
4	B4B-XH-TV4	B4B-XH-2-TV4	7.5(.295)	12.4(.488)	500
5	—	B5B-XH-2-TV4	10.0(.394)	14.9(.587)	500
6	—	B6B-XH-2-TV4	12.5(.492)	17.4(.685)	500
7	—	B7B-XH-2-TV4	15.0(.591)	19.9(.783)	500
8	—	B8B-XH-2-TV4	17.5(.689)	22.4(.882)	500

Material and Finish

Post: Copper alloy, copper-undercoated, tin/lead-plated

Wafer: TV4 type/ Nylon 66, UL94V-0

2-TV4 type/ Glass-filled nylon 66, UL94V-0

<For reference> As the color identification, the following alphabet shall be put in the underlined part. For availability, delivery and minimum order quantity, contact JST.

ex. **B2B-XH-2-TV4-oo**
 (blank)...natural (ivory)
 C...black (glass-filled) BK...black R...red E...blue Y...yellow
 M...green

Taping specification of through-hole type shrouded header

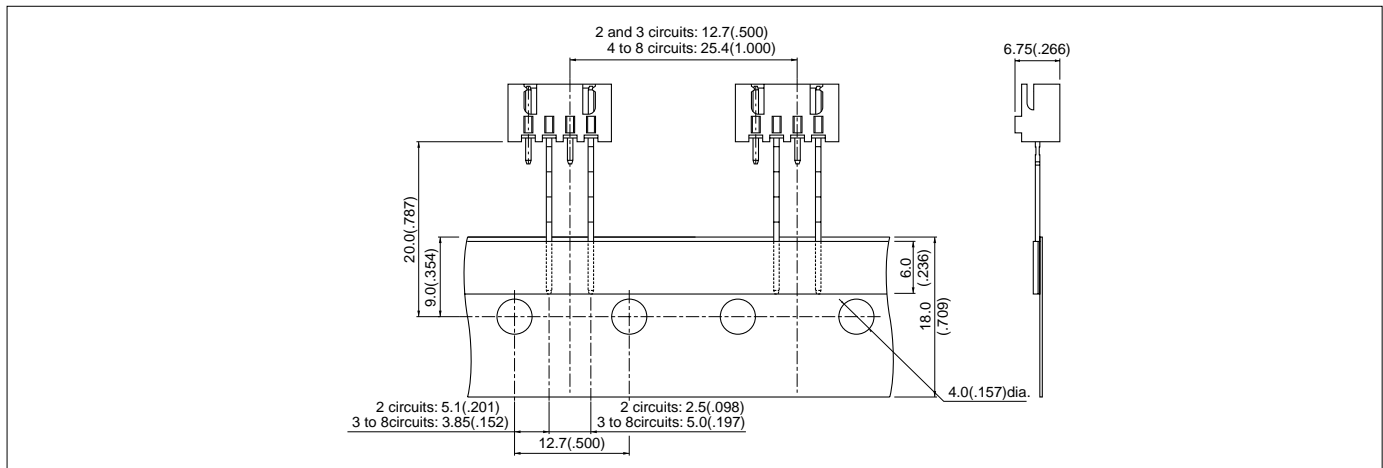

Note: Conforms to JIS C 0806.

Packaging specifications of through-hole type shrouded header

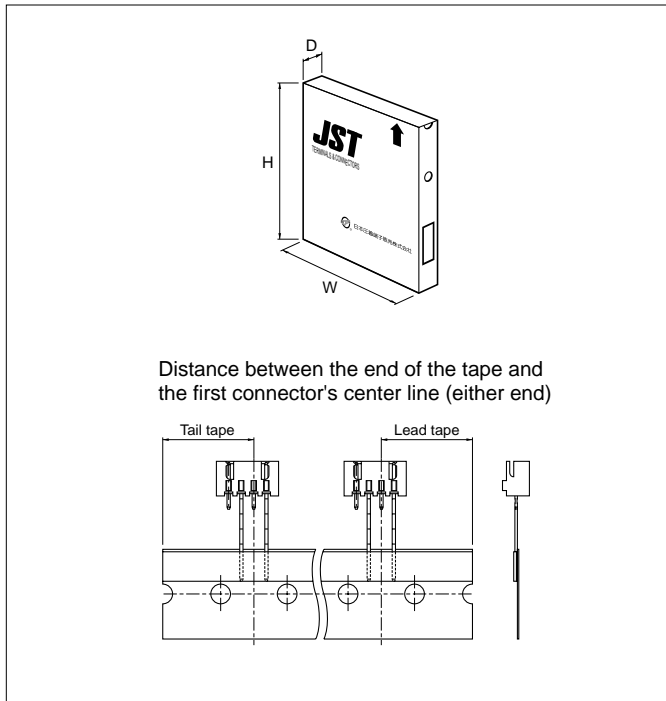

Package type	Flat pack (zig zag folded)
Distance between folds	24 indexing holes perfold (304.8mm/12")
Box size	(316x45x330mm)12.4"(W)x1.8"(D)x13.0"(H)
Distance between the end of the tape and the first connector's center line (either end)	19.05mm(.750")

Products of different packaging specifications are also available. Contact JST for details.

Through-hole type PC board layout (viewed from soldering side) and Assembly layout

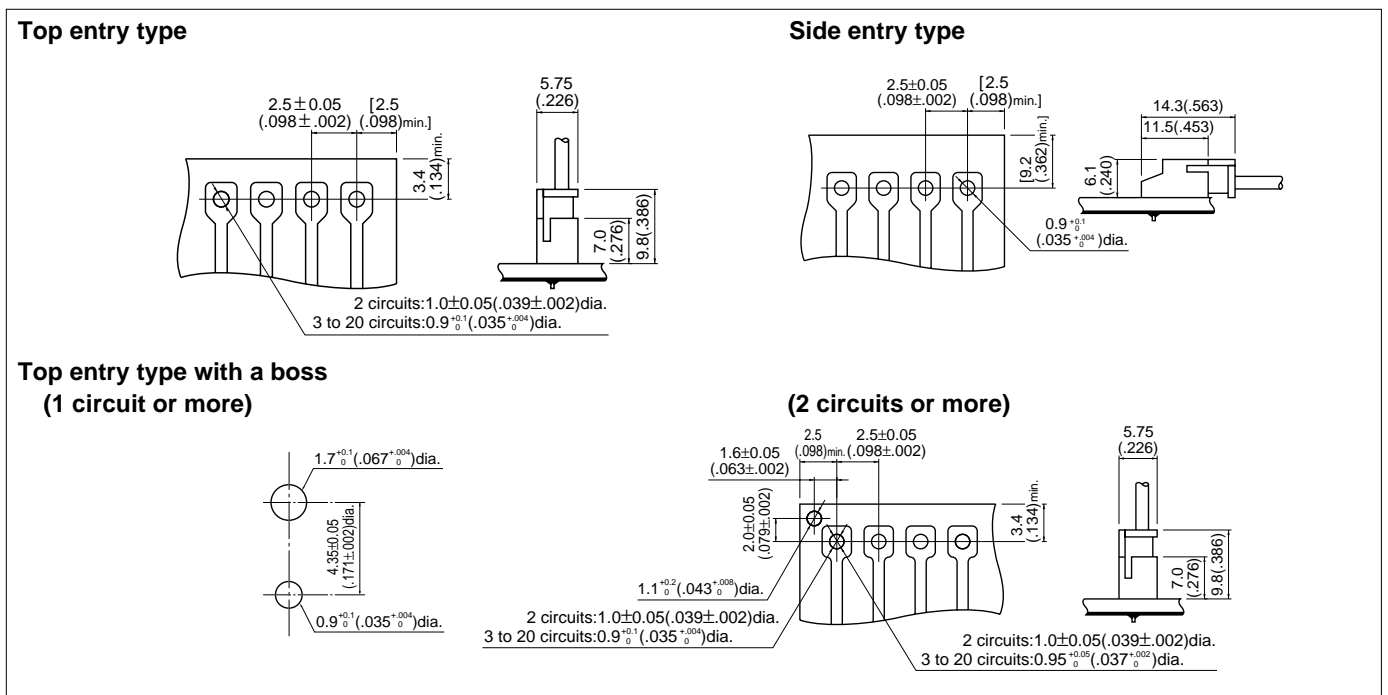

Note:

1. Tolerances are non-cumulative: ±0.05mm(±.002") for all centers.
2. Hole dimensions differ according to the kind of PC board and piercing method. If printed circuit boards made of hard material are used, the hole dimensions should be larger. The dimensions above should serve as a guideline. Contact JST for details.

XH CONNECTOR

SMT type shrouded header

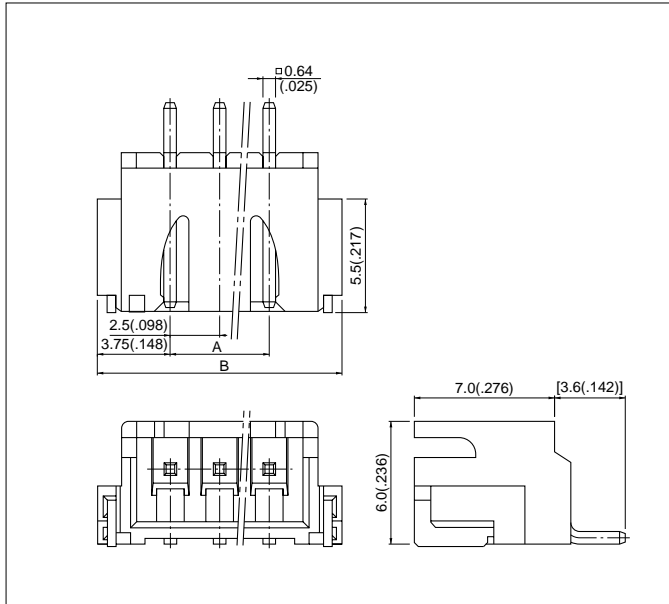

Circuits	Model No.	Dimensions mm(in.)		Q'ty / reel
		A	B	
3	S3B-XH-SM3-TB	5.0(.197)	12.5(.492)	500
4	S4B-XH-SM3-TB	7.5(.295)	15.0(.591)	500
6	S6B-XH-SM3-TB	12.5(.492)	20.0(.787)	500

Material and Finish	
Pin:	Copper alloy, copper-undercoated, tin/lead-plated
Wafer:	Nylon 46, UL94V-0, natural (white)
Solder tab:	Brass, copper-undercoated, tin/lead-plated

Note: The products listed above are supplied on embossed-tape.

<For reference> As the color identification, the following alphabet shall be put in the underlined part. For availability, delivery and minimum order quantity, contact JST.

ex. **S3B-XH-SM3-oo-TB**
 (blank)...natural (white)
 M...green R...red E...blue L...lemon yellow

Taping specifications of SMT type shrouded header

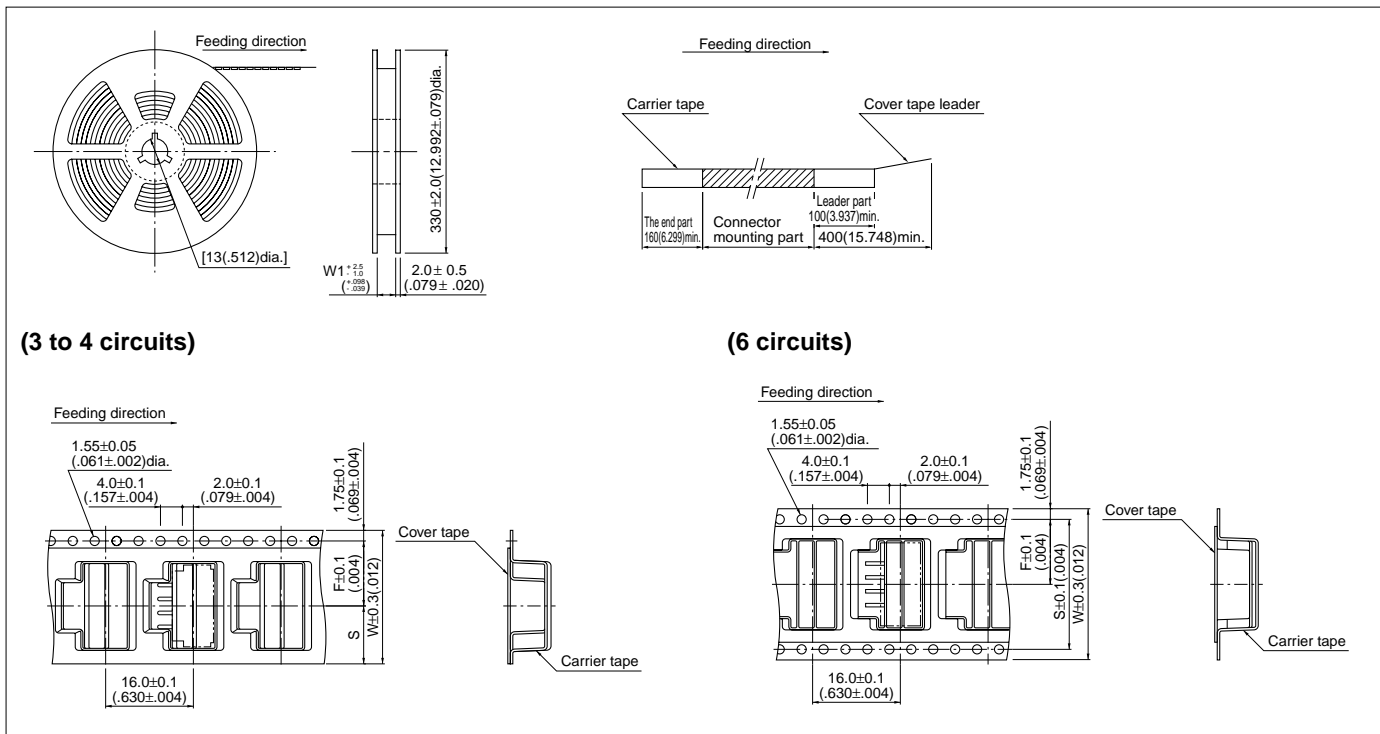

(3 to 4 circuits)

(6 circuits)

Circuits	Taping dimensions mm(in.)			Reel dimensions mm(in.)	Q'ty / reel
	F	S	W		
3, 4	11.5(.453)	—	24.0(.945)	25.5(1.004)	500
6	14.2(.559)	28.4 (1.118)	32.0(1.260)	33.5(1.319)	500

Note:

- Specifications conform to JIS C 0806. The tape width, connector recess dimensions, etc. are determined by the number of circuits and external shape of the connector to be loaded.
- Specifications are subject to change without prior notice.

SMT type PC board layout (viewed from component side)

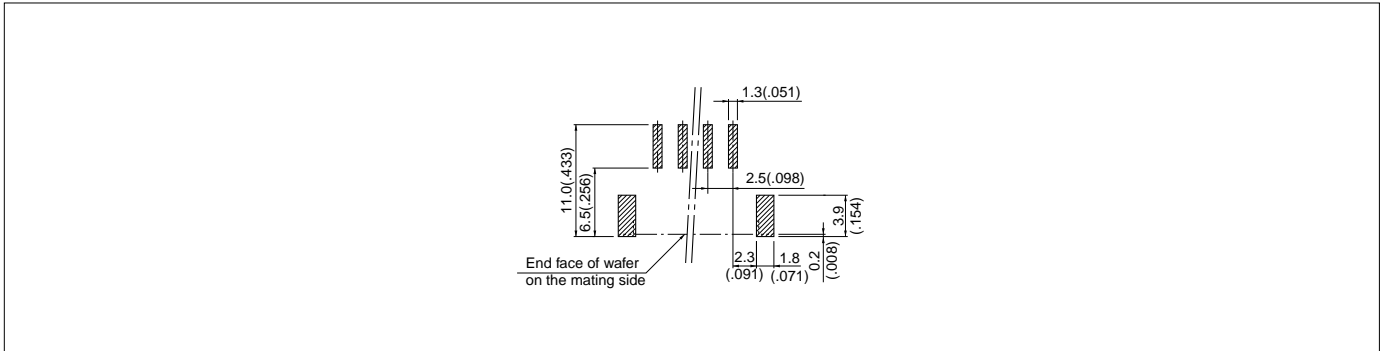

Note:

1. Tolerances are non-cumulative: $\pm 0.05\text{mm} (\pm .002")$ for all centers.
2. The dimensions above should serve as a guideline. Contact JST for details.

Applicator for the semi-automatic press AP-K2N

Contact	Crimp applicator MKS-L		Compact crimp applicator MKS-LS		Strip-crimp applicator MKS-SC
	with safety cover	without safety cover	with safety cover	without safety cover	with safety cover
SXH-001T-P0.6N	APLMK SXH001-06N	APLNC SXH001-06N	APLMKLS SXH001-06N	APLLSNC SXH001-06N	APLSC SXH001-06N
SXH-001T-P0.6	APLMK SXH001-06	APLNC SXH001-06	APLMKLS SXH001-06	APLLSNC SXH001-06	APLSC SXH001-06
SXH-002T-P0.6	APLMK SXH002-06	APLNC SXH002-06	APLMKLS SXH002-06	APLLSNC SXH002-06	APLSC SXH002-06