



## CFAF240400C0-030SC IPS TFT DISPLAY MODULE DATASHEET



Datasheet Release Date 2019-06-03  
for  
**CFAF240400C0-030SC**

### **Crystalfontz America, Inc.**

12412 East Saltese Avenue  
Spokane Valley, WA 99216-0357  
Phone: 888-206-9720  
Fax: 509-892-1203  
Email: [support@crystalfontz.com](mailto:support@crystalfontz.com)  
URL: [www.crystalfontz.com](http://www.crystalfontz.com)



## **CONTENTS**

1. General Information .....	3
2. Module Description .....	4
3. Features .....	4
4. Mechanical Data .....	4
5. Mechanical Drawing .....	5
6. Display Pin Table .....	7
7. Interface Table .....	7
8. Capacitive Touch Pin Table .....	8
9. Absolute Maximum Ratings .....	8
10. Electrical Characteristics .....	8
11. Optical Characteristics .....	8
12. Backlight Characteristics .....	9
13. LCD Module Precautions .....	10
13.1. Modules .....	10
13.2. Handling Precautions .....	10
13.3. Storage Precautions .....	11
13.4. Designing Precautions .....	11
13.5. Disposing Precautions .....	11
13.6. Other Precautions .....	11



## 1. General Information

### Datasheet Revision History

Datasheet Release: **2019-06-03**  
Datasheet for the CFAF240400C0-030SC TFT graphic display module.

### Product Change Notifications

You can check for or subscribe to [Part Change Notices](#) for this display module on our website.

### Variations

Slight variations between lots are normal (e.g., contrast, color, or intensity).

### Volatility

This display module has volatile memory.

### Disclaimer

Certain applications using CrystalFontz America, Inc. products may involve potential risks of death, personal injury, or severe property or environmental damage ("Critical Applications"). CRYSTALFONTZ AMERICA, INC. PRODUCTS ARE NOT DESIGNED, INTENDED, AUTHORIZED, OR WARRANTED TO BE SUITABLE FOR USE IN LIFE-SUPPORT APPLICATIONS, DEVICES OR SYSTEMS OR OTHER CRITICAL APPLICATIONS. Inclusion of CrystalFontz America, Inc. products in such applications is understood to be fully at the risk of the customer. In order to minimize risks associated with customer applications, adequate design and operating safeguards should be provided by the customer to minimize inherent or procedural hazard. Please contact us if you have any questions concerning potential risk applications.

CrystalFontz America, Inc. assumes no liability for applications assistance, customer product design, software performance, or infringements of patents or services described herein. Nor does CrystalFontz America, Inc. warrant or represent that any license, either express or implied, is granted under any patent right, copyright, or other intellectual property right of CrystalFontz America, Inc. covering or relating to any combination, machine, or process in which our products or services might be or are used.

All specifications in datasheets on our website are, to the best of our knowledge, accurate but not guaranteed. Corrections to specifications are made as any inaccuracies are discovered.

Company and product names mentioned in this publication are trademarks or registered trademarks of their respective owners.

Copyright © 2018 by CrystalFontz America, Inc., 12412 East Saltese Avenue, Spokane Valley, WA 99216 U.S.A.



## 2. Module Description

This is a full color IPS TFT graphic display module with a bright white LED backlight and built in capacitive touch screen. This display is also designed with a ZIF tail for easy PCA integration.

This display has a selectable color resolution between an 8 color span, a 65k color span, and a 262k color span.

This display has a built-in ILITEK ILI9327 controller; see the [ILITEK ILI9327 controller datasheet](#) for further reference including controller command sets and settings descriptions.

## 3. Features

- 240\*400 Dot Matrix
- High Brightness LED Backlight
- Any Angle Viewing Direction
- Built-in Controller: ILITEK ILI9327
- Operating Temperature: -20°C ~+70°C
- Storage Temperature: -30°C~+80°C
- +3.3V Power Supply
- Interface: 8/9/16/18-bit Parallel , RGB, SPI

## 4. Mechanical Data

Item	Specification (mm)	Specification (inch, reference)
Overall Width and Height	45.04 (W) x 77.00 (H) x 3.85 (D)	1.7732 (W) x 3.0315 (H) x .1516 (D)
Viewing Area	39.54 (W) x 66.00 (H)	1.5567 (W) x 2.5984 (H)
Active Area	39.24 (W) x 65.40 (H)	1.5449 (W) x 2.5748 (H)
Dot Pitch	0.1635 (W) x 0.1635 (H)	0.0064 (W) x 0.0064 (H)
Weight (Typical)	19.6 grams	0.69 ounces

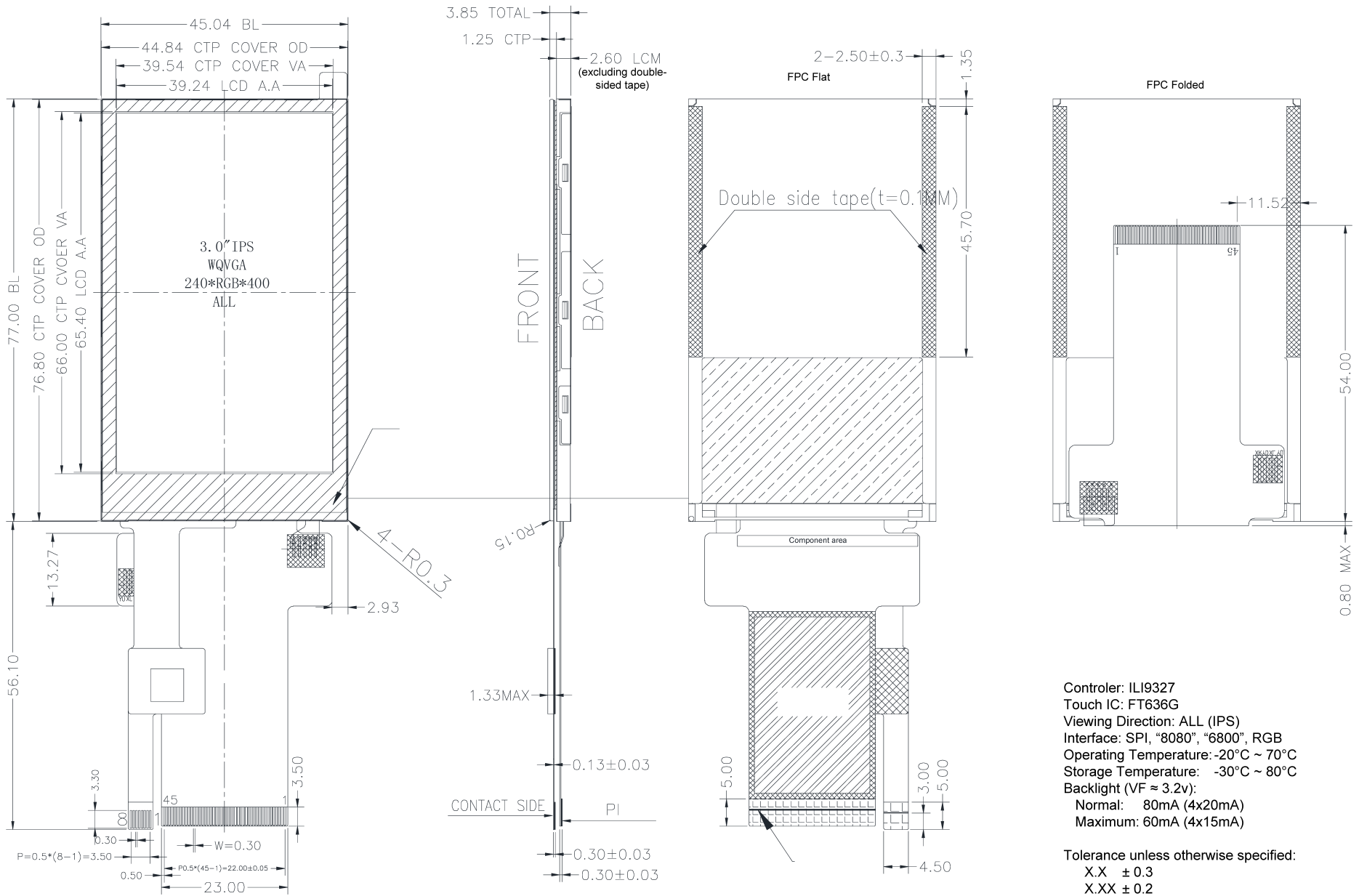

Controller: ILI9327  
 Touch IC: FT636G  
 Viewing Direction: ALL (IPS)  
 Interface: SPI, "8080", "6800", RGB  
 Operating Temperature: -20°C ~ 70°C  
 Storage Temperature: -30°C ~ 80°C  
 Backlight (VF ≈ 3.2v):  
 Normal: 80mA (4x20mA)  
 Maximum: 60mA (4x15mA)

Tolerance unless otherwise specified:  
 X.X ± 0.3  
 X.XX ± 0.2



CrystalFontz

© 2019 CrystalFontz America, Inc.

Part Number:

**CFAF240400C0-030SC**

Date:

2019-03-06

Filename:

CFAF240400C0-030SC\_Mechanical.pdf

Revision:

-

Web:

<https://www.crystallfontz.com/product/cfaf240400c0030sc>

Sheet:

1 of 2

**EXAMPLE BACKLIGHT DRIVING CIRCUIT**  
 For optimal backlight longevity and performance, we strongly recommend using a constant-current LED driver. ON Semiconductor CAT3604VHV4-GT2 or similar.

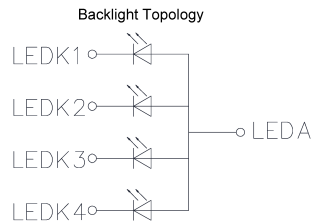
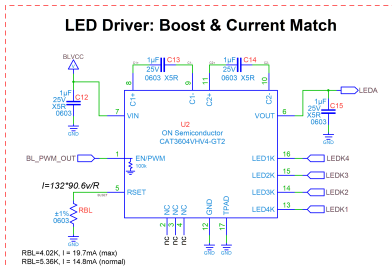

**CFAF240400C0-030TSC Interface Selection (IL19327)**

IM2	IM1	IM0	Interface (pins used)
low	low	low	MCU 18-bit (D/C, RD, WR, DB[17:0])
low	low	HIGH	MCU 9-bit (D/C, RD, WR, DB[8:0])
low	HIGH	low	MCU 16-bit (D/C, RD, WR, DB[15:0])
low	HIGH	HIGH	MCU 8-bit (D/C, RD, WR, DB[7:0])
HIGH	low	low	reserved
HIGH	low	HIGH	9-bit SPI (CS, SCK, DATA or MOSI&MISO)*
HIGH	HIGH	low	reserved
HIGH	HIGH	HIGH	8-bit SPI (CS, D/C, SCK, DATA or MOSI&MISO)*

\*Interface control register (C8h) SDA\_EN:  
 0: DIN/SDA pin is uni-direction (DIN) and DOUT is active  
 1: DIN/SDA pin is bi-direction (SDA) and DOUT is unused

CTP	
NO.	Pin Name
1	GND
2	VDDIO
3	VDD
4	SCL
5	SDA
6	INT
7	RST
8	GND

NO.	Pin Name
1	IM0
2	IM1
3	IM2
4	nRESET
5	VSYNC
6	HSYNC
7	PCLK
8	DE
9	DB17/R7
10	DB16/R6
11	DB15/R5
12	DB14/R4
13	DB13/R3
14	DB13/R2
15	DB11/G7
16	DB10/G6
17	DB9/G5
18	DB8/G4
19	DB7/G3
20	DB6/G2
21	DB5/B7
22	DB4/B6
23	DB3/B5
24	DB2/B4
25	DB1/B3
26	DB0/B2
27	MISO (DOUT/SDO)
28	MOSI (DIN/SDA)
29	nRD
30	SCK (nWR/SCL)
31	D/nC (RS/A0)
32	nCS
33	VCC
34	VCC
35	GND
36	GND
37	LEDK4
38	LEDK3
39	LEDK2
40	LEDK1
41	LEDA
42	X+(XR)
43	Y-(YD)
44	X-(XL)
45	Y+(YU)



Crystalfontz

© 2019 Crystalfontz America, Inc.

Part Number:

**CFAF240400C0-030SC**

Date:

2019-03-06

Filename:

CFAF240400C0-030SC\_Mechanical.pdf

Revision:

-

Web:

<https://www.crystalfontz.com/product/cfaf240400c0030sc>

Sheet:

2 of 2



## 6. Display Pin Table

PIN No.	Symbol	Function
1	IM0	Interface Select
2	IM1	Interface Select
3	IM2	Interface Select
4	RESET	Active LOW Reset
5	VSYNC	Vertical Sync. Used in RGB mode. If not used, set to GND
6	HSYNC	Horizontal Sync. Used in RGB mode. If not used, set to GND
7	PCLK	Pixel Clock. Used in RGB mode. If not used, set to GND
8	DE	Data Enable. Used in RGB mode. If MDDI mode is set and this pin is not in use, leave open. Otherwise if not being used, set to GND
9-26	DB17- DB00	Data bus pins. If MDDI mode is set and these pins are not in use, leave open. Otherwise if not being used, set to GND
27	SD0	Serial Data Output
28	DIN/SDA	Serial Data Input
29	RD	Read Select
30	WR/SCL	Write Select/Serial Clock.
31	RS	Register Select (Data/Command select) 1 = Data, 0 = Command
32	CS	Chip Select Active LOW
33-34	VCC	Supply Voltage 2.5V-3.6V
35-36	GND	Ground
37	LEDK4	LED 4 Cathode
38	LEDK3	LED 3 Cathode
39	LEDK2	LED 2 Cathode
40	LEDK1	LED 1 Cathode
41	LEDA	LED Anode
42	XR	NC
43	YD	NC
44	XL	NC
45	YU	NC

## 7. Interface Table

IM0	IM1	IM2	Function
0	0	0	18-bit interface
0	0	1	9-bit interface, MDDI
0	1	0	16-bit interface
0	1	1	8-bit interface
1	0	1	3-Wire SPI
1	1	1	4-Wire SPI

Notes:

(1) RGB can be used in conjunction with SPI. See Appendix for detailed pinouts.



## 8. Capacitive Touch Pin Table

PIN No.	Symbol	Function
1	GND	Ground
2	VDDIO	I/O Power Supply Voltage
3	VDD	Supply Voltage
4	SCL	I2C Clock
5	SDA	I2C Data Input/Output
6	INT	Interrupt to the Host
7	RESET	Reset Active LOW
8	GND	Ground

## 9. Absolute Maximum Ratings

Parameter	Symbol	Min	Max	Unit	Notes
Supply Voltage	V <sub>CC</sub>	-0.3	4.6	V	(1)(2)(3)
Operating Temperature	T <sub>OP</sub>	-20	+70	°C	-
Storage Temperature	T <sub>STG</sub>	-30	+80	°C	-

Notes:

- (2) These are stress ratings only. Extended exposure to the absolute maximum ratings listed above may affect device reliability or cause permanent damage.  
 (3) Functional operation should be restricted to the limits in the Electrical Characteristics table below.

## 10. Electrical Characteristics

Item	Symbol	Condition	Min	Typ	Max	Unit
Supply Voltage	V <sub>CC</sub>	-	2.4	3.3	3.6	V
High-level Input	V <sub>IH</sub>	-	0.7 x V <sub>CC</sub>	-	V <sub>CC</sub>	V
Low-level Input	V <sub>IL</sub>	-	GND	-	0.3 x V <sub>CC</sub>	V
High-level Output	V <sub>OH</sub>	-	0.8 x V <sub>CC</sub>	-	V <sub>CC</sub>	V
Low-level Output	V <sub>OL</sub>	-	GND	-	0.2 x V <sub>CC</sub>	V
50% Check Board Operating Current	I <sub>CDD</sub>	V <sub>CC</sub> = 3.0V	-	8	-	mA

## 11. Optical Characteristics

Item	Symbol	Condition	Min	Typ	Max	Unit
View Angle	Horizontal	CR>10	-	160	-	deg
	Left		-	80	-	deg
	Right		-	80	-	deg
	Vertical		-	160	-	deg
	Top		-	80	-	deg
	Bottom		-	80	-	deg
Contrast Ratio	CR	Θ=0	400:1	500:1	-	-
Response Time	T <sub>rise</sub> + T <sub>fall</sub>		-	35	50	ms





## 12. Backlight Characteristics

Item	Condition	Symbol	Min	Typ	Max	Unit
Supply Current	V=3.2v	I	60	80	-	mA
Supply Voltage	I <sub>F</sub> =80mA	V	-	3.2	-	V
Luminous Intensity for LCM		I <sub>v</sub>	340	-	-	cd/m <sup>2</sup>
LED Lifetime		-	50K	-	-	Hr.
Color	White					

**Notes:**

- (1) Supply current minimum value is only for reference since the LED brightness efficiency keeps enhancing. Current consumption becomes less and less to achieve the same luminance.
- (2) Lifetime is defined as the amount of time when the luminance has decayed to <50% of the initial value (50K hours is an estimate for reference only).



## 13. LCD Module Precautions

The precautions below should be followed when using LCD modules to help ensure personal safety, module performance, and compliance of environmental regulations.

### 13.1. Modules

- Avoid applying excessive shocks to module or making any alterations or modifications to it.
- Do not make extra holes on the printed circuit board, modify its shape or change the components of LCD display module.
- Do not disassemble the LCD display module.
- Do not operate the LCD display module above the absolute maximum rating.
- Do not drop, bend or twist the LCD display module.
- Store in an anti-static electricity container and clean environment.
- It is common to use the "screen saver" to extend the lifetime of the LCD display module.
  - Do not use the fixed information for long periods of time in real application.
  - Do not use fixed information in LCD panel for long periods of time to extend "screen burn" effect time.
- Crystalfontz has the right to change the passive components (Resistors, capacitors and other passive components will have different appearance and color caused by the different supplier.)
- Crystalfontz have the right to change the PCB Rev. (In order to satisfy the supplying stability, management optimization and the best product performance, etc., under the premise of not affecting the electrical characteristics and external dimensions, Crystalfontz has the right to modify the version.)

### 13.2. Handling Precautions

- Do not apply mechanical impacts such as dropping from a high position.
- If the display panel is accidentally broken, and the internal organic substance leaks out, be careful not to inhale or touch the organic substance.
- If pressure is applied to the display surface or its neighborhood of the LCD display module, the cell structure may be damaged, so be careful not to apply pressure to these sections.
- The polarizer covering the surface of the LCD display module is soft and can be easily scratched. Please be careful when handling the LCD display module.
- Clean the surface of the polarizer covering the LCD display module if it becomes soiled using following adhesion tape.
  - Scotch Mending Tape No. 810 or an equivalent
  - Never breathe the soiled surface or wipe the surface using a cloth containing solvent such as ethyl alcohol, since the surface of the polarizer will become cloudy.
  - The following liquids/solvents may spoil the polarizer:
    - Water
    - Ketone
    - Aromatic Solvents
- Hold the LCD display module very carefully when placing the LCD display module into the system housing.
- Do not apply excessive stress or pressure to the LCD display module. And, do not over bend the film with electrode pattern layouts. These stresses will influence the display performance. Also, be sure to secure the sufficient rigidity for the outer cases.

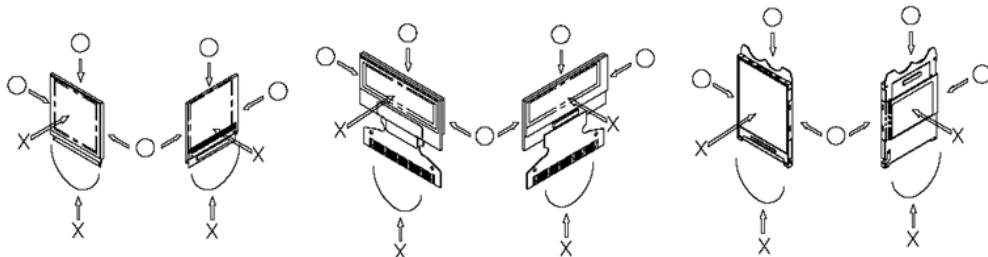



- Do not apply stress to the LSI chips and the surrounding molded sections.
- Do not disassemble or modify the LCD display module.
- Do not apply input signals while the logic power is off.
- Pay sufficient attention to the working environments when handing the LCD display module to prevent occurrence of element breakage accidents by static electricity.
  - Be sure to make human body grounding when handling LCD display modules.
  - Be sure to ground tools to use for assembly such as soldering irons.
  - To suppress generation of static electricity, avoid carrying out assembly work under dry environments.
  - Protective film is being applied to the surface of the display panel of the LCD display module. Be careful since static electricity may be generated when exfoliating the protective film.
- Protection film is being applied to the surface of the display panel and removes the protection film before assembling it. At this time, if the LCD display module has been stored for a long period of time, residue adhesive material of the protection film may remain on the surface of the display panel after the film has been removed. In such a case, remove the residue material by the method discussed above.
- If electric current is applied when the LCD display module is being dewed or when it is placed under high humidity environments, the electrodes may become corroded. If this happens proceed with caution when handling the LCD display module.

### 13.3. Storage Precautions

- When storing the LCD display modules put them in static electricity preventive bags to avoid exposure to direct sunlight and fluorescent lamps. Also avoid high temperature and high humidity environments and low temperatures (less than 0°C) environments. (We recommend you store these modules in the packaged state when they were shipped from Crystalfontz). Be careful not to let water drops adhere to the packages or bags, and do not let dew gather on them.
- If electric current is applied when water drops are adhering to the surface of the LCD display module the LCD display module may have become dewed. If a dewed LCD display module is placed under high humidity environments it may cause the electrodes to become corroded. If this happens proceed with caution when handling the LCD display module.

### 13.4. Designing Precautions

- The absolute maximum ratings are the ratings that cannot be exceeded for LCD display module. If these values are exceeded, panel damage may happen.
- To prevent occurrence of malfunctioning by noise pay attention to satisfy the  $V_{IL}$  and  $V_{IH}$  specifications and, at the same time, to make the signal line cable as short as possible.
- We recommend that you install excess current preventive unit (fuses, etc.) to the power circuit ( $V_{DD}$ ). (Recommend value: 0.5A)
- Pay sufficient attention to avoid occurrence of mutual noise interference with the neighboring devices.
- As for EMI, take necessary measures on the equipment side.
- When fastening the LCD display module, fasten the external plastic housing section.
- If the power supply to the LCD display module is forcibly shut down, by such errors as taking out the main battery while the LCD display panel is in operation, we cannot guarantee the quality of this LCD display module.
  - Connection (contact) to any other potential than the above may lead to rupture of the IC.

### 13.5. Disposing Precautions

- Request the qualified companies to handle the industrial wastes when disposing of the LCD display modules. Or, when burning them, be sure to observe the environmental and hygienic laws and regulations.

### 13.6. Other Precautions

- When an LCD display module is operated for a long period of time with a fixed pattern, the fixed pattern may remain as an after image or a slight contrast deviation may occur.
  - If the operation is interrupted and left unused for a while, normal state can be restored.



- This will not cause a problem in the reliability of the module.
- To protect the LCD display module from performance drops by static electricity rapture, etc., do not touch the following sections whenever possible while handling the LCD display modules.
  - Pins and electrodes
  - Pattern layouts such as the TCP & FPC
- Although this LCD display module stores the operation state data by the commands and the indication data, when excessive external noise, etc. enters into the module, the internal status may be changed. Therefore, it is necessary to take appropriate measures to suppress noise generation or to protect from influences of noise on the system design.
- We recommend that you construct its software to make periodical refreshment of the operation statuses (re-setting of the commands and re-transference of the display data), to cope with catastrophic noise.
- Resistors, capacitors, and other passive components will have different appearance and color caused by the different supplier.
- Crystalfontz has the right to upgrade and modify the product function.



Appendix A: 8-bit Interface

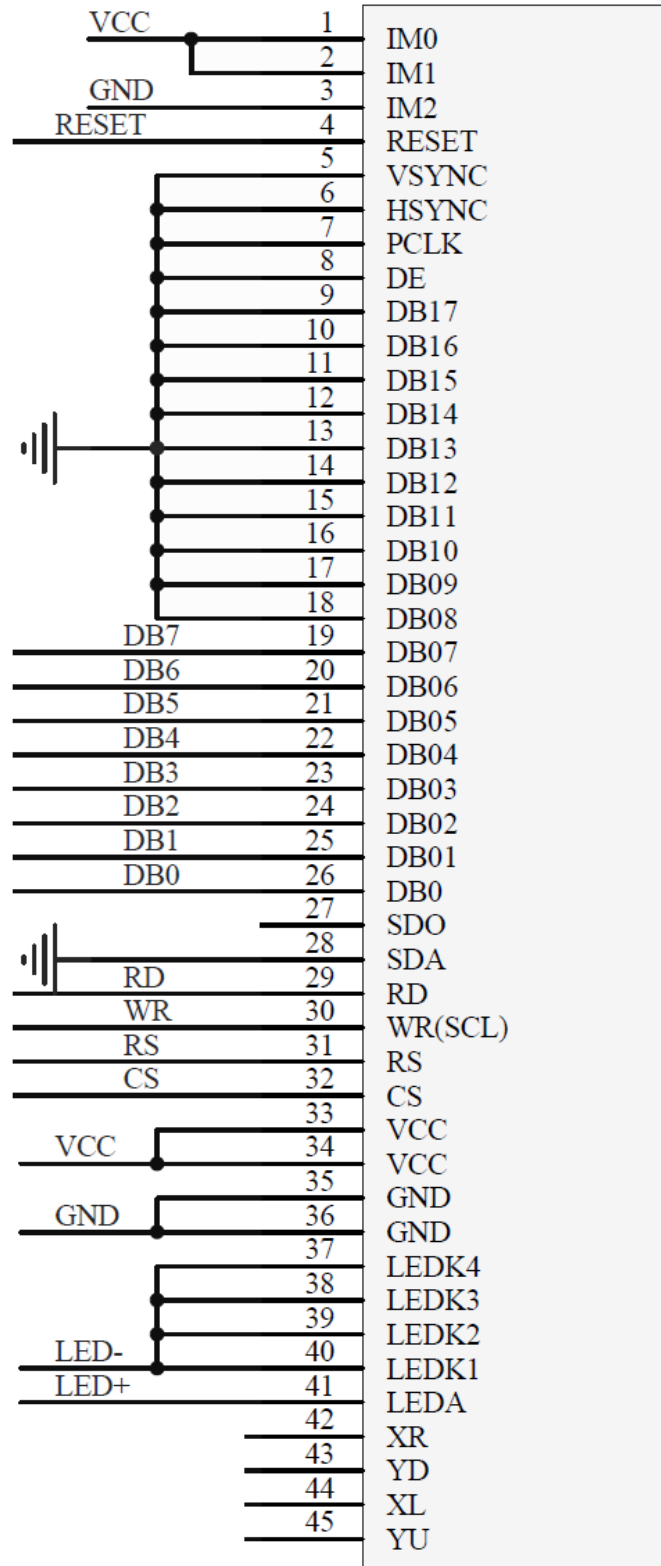



Appendix B: 9-bit Interface

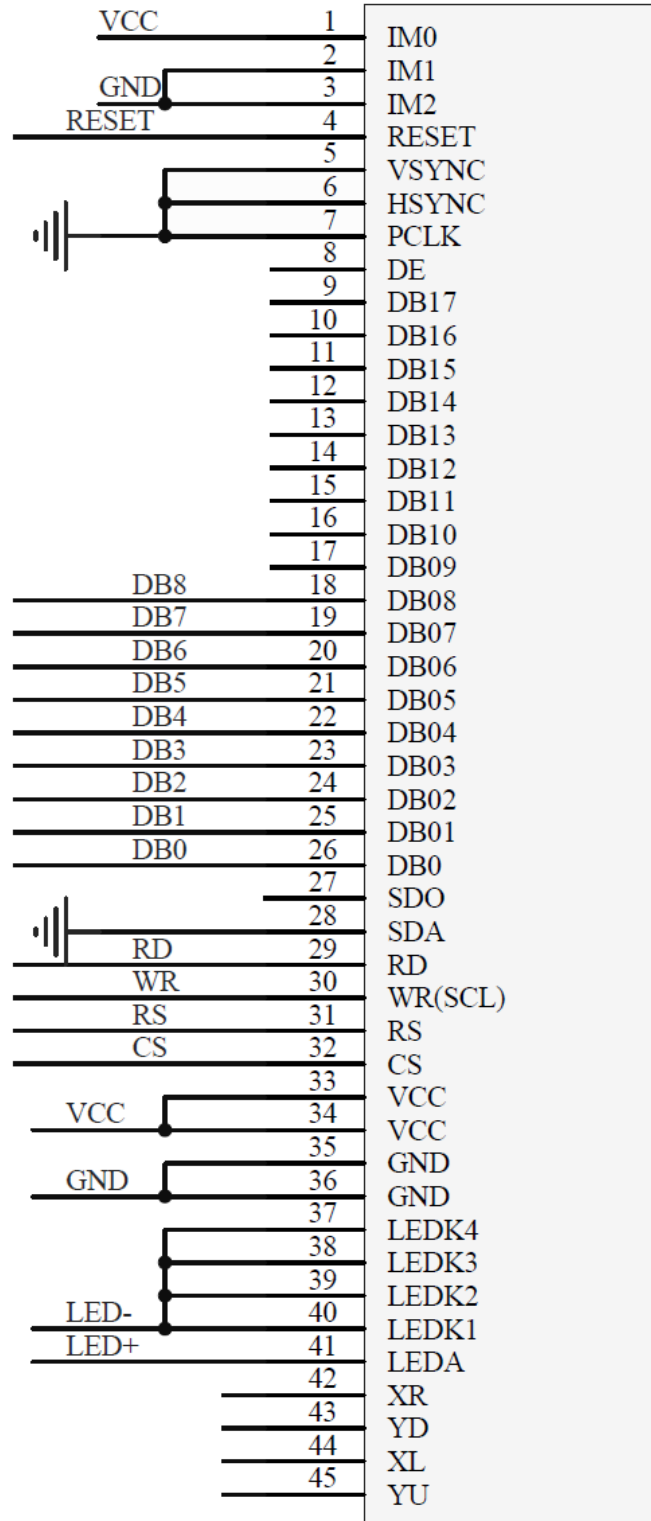



Appendix C: 16-bit Interface

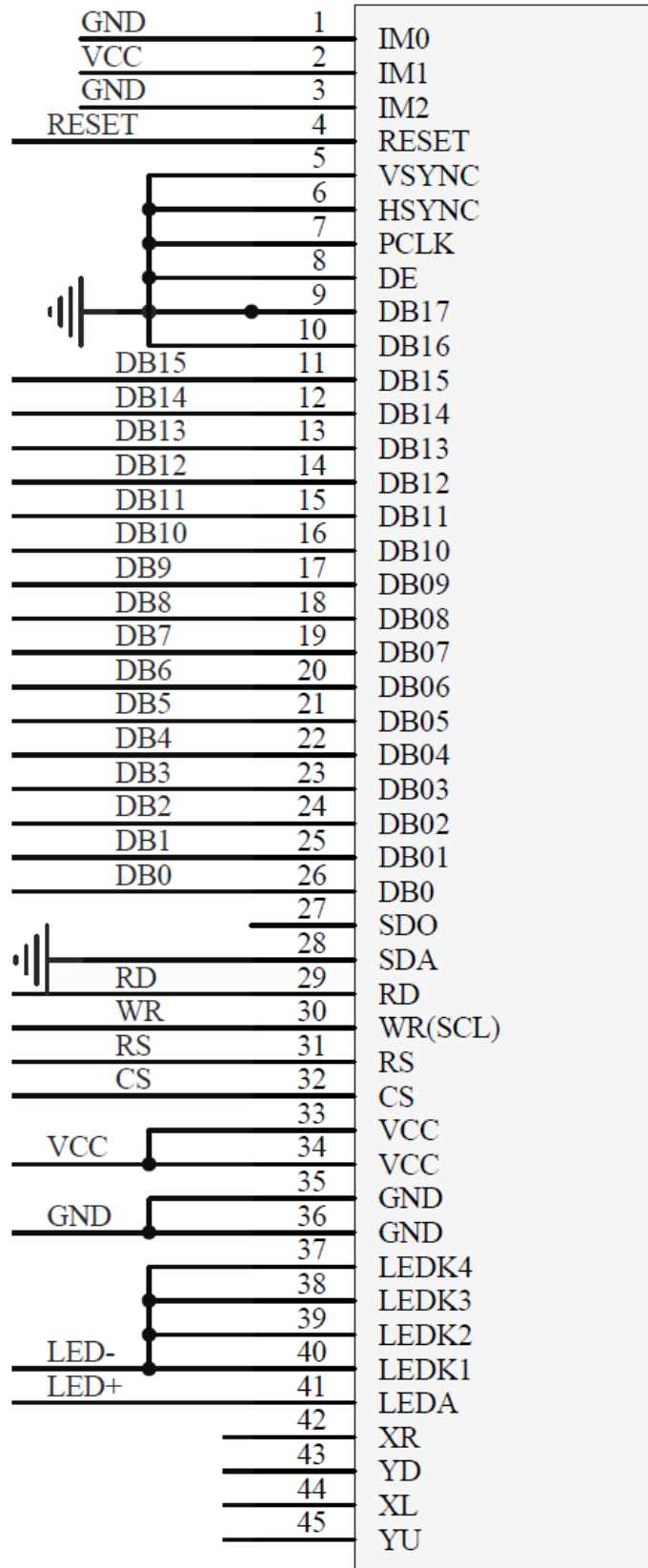



Appendix D: 18-bit Interface

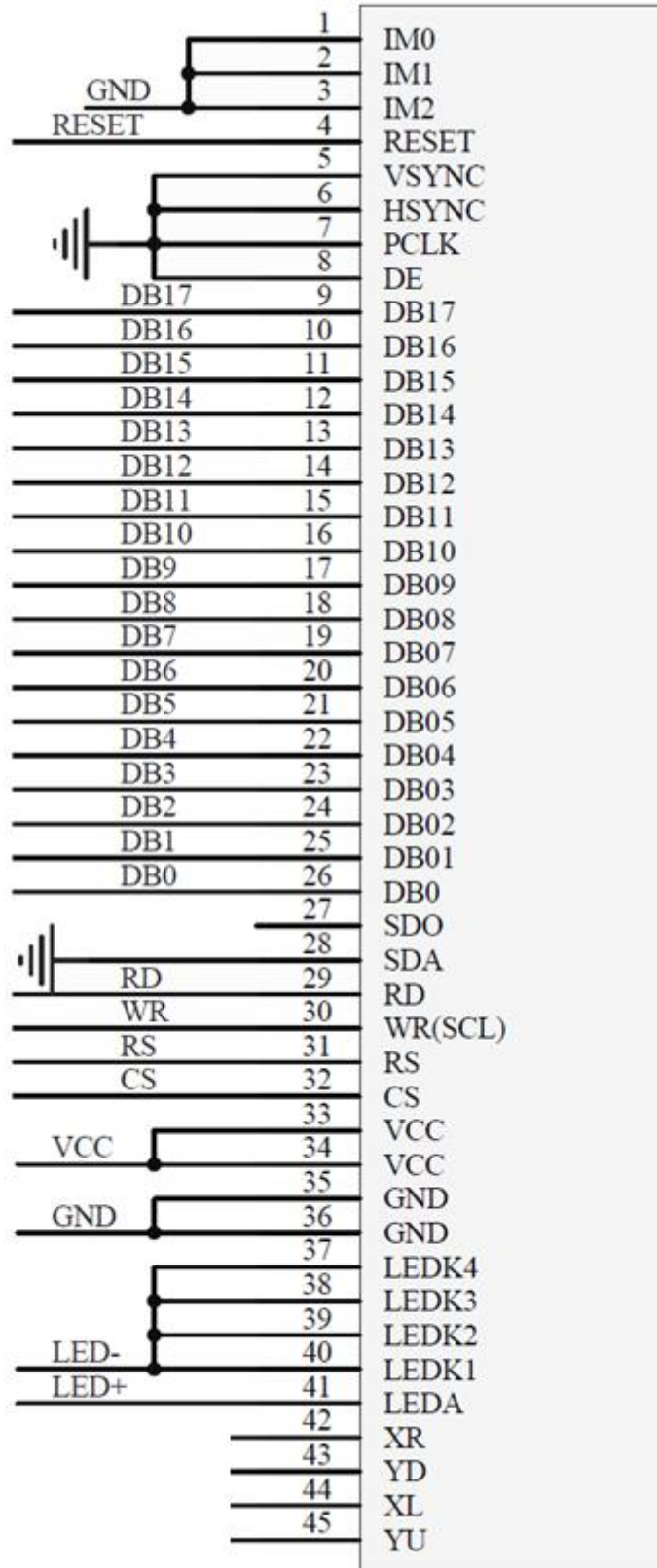





Appendix E: 3-Wire SPI + 16-bit Interface

VCC	1	IM0
GND	2	IM1
VCC	3	IM2
RESET	4	RESET
VSYNC	5	VSYNC
HSYNC	6	HSYNC
DOTCLK	7	PCLK
DEN	8	DE
R4	9	DB17
R3	10	DB16
R2	11	DB15
R1	12	DB14
R0	13	DB13
	14	DB12
G5	15	DB11
G4	16	DB10
G3	17	DB09
G2	18	DB08
G1	19	DB07
G0	20	DB06
B4	21	DB05
B3	22	DB04
B2	23	DB03
B1	24	DB02
B0	25	DB01
	26	DB0
SDA	27	SDO
	28	SDA
SCL	29	RD
	30	WR(SCL)
CS	31	RS
	32	CS
VCC	33	VCC
	34	VCC
GND	35	GND
	36	GND
	37	LEDK4
	38	LEDK3
	39	LEDK2
LED-	40	LEDK1
LED+	41	LEDA
	42	
	43	XR
	44	YD
	45	XL
		YU



Appendix F: 3-Wire SPI + 18-bit Interface

VCC	1	IM0
GND	2	IM1
VCC	3	IM2
RESET	4	RESET
VSYNC	5	VSYNC
HSYNC	6	HSYNC
DOTCLK	7	PCLK
DEN	8	DE
R5	9	DB17
R4	10	DB16
R3	11	DB15
R2	12	DB14
R1	13	DB13
R0	14	DB12
G5	15	DB11
G4	16	DB10
G3	17	DB09
G2	18	DB08
G1	19	DB07
G0	20	DB06
B5	21	DB05
B4	22	DB04
B3	23	DB03
B2	24	DB02
B1	25	DB01
B0	26	DB0
	27	SDO
SDA	28	SDA
	29	RD
SCL	30	WR(SCL)
	31	RS
CS	32	CS
	33	VCC
VCC	34	VCC
	35	GND
GND	36	GND
	37	LEDK4
	38	LEDK3
	39	LEDK2
LED-	40	LEDK1
LED+	41	LEDA
	42	XR
	43	YD
	44	XL
	45	YU



Appendix G: 4-Wire SPI + 16-bit Interface

VCC	1	IM0
	2	IM1
	3	IM2
RESET	4	RESET
VSYNC	5	VSYNC
HSYNC	6	HSYNC
DOTCLK	7	PCLK
DEN	8	DE
R4	9	DB17
R3	10	DB16
R2	11	DB15
R1	12	DB14
R0	13	DB13
	14	DB12
G5	15	DB11
G4	16	DB10
G3	17	DB09
G2	18	DB08
G1	19	DB07
G0	20	DB06
B4	21	DB05
B3	22	DB04
B2	23	DB03
B1	24	DB02
B0	25	DB01
	26	DB0
SDA	27	SDO
	28	SDA
	29	RD
SCL	30	WR(SCL)
RS	31	RS
CS	32	CS
	33	VCC
VCC	34	VCC
	35	VCC
GND	36	GND
	37	GND
	38	LEDK4
	39	LEDK3
LED-	40	LEDK2
LED+	41	LEDK1
	42	LEDA
XR	43	XR
YD	44	YD
XL	45	XL
YU	45	YU



Appendix H: 4-Wire SPI +18-bit Interface

VCC	1	IM0
	2	IM1
	3	IM2
RESET	4	RESET
VSYNC	5	VSYNC
HSYNC	6	HSYNC
DOTCLK	7	PCLK
DEN	8	DE
R5	9	DB17
R4	10	DB16
R3	11	DB15
R2	12	DB14
R1	13	DB13
R0	14	DB12
G5	15	DB11
G4	16	DB10
G3	17	DB09
G2	18	DB08
G1	19	DB07
G0	20	DB06
B5	21	DB05
B4	22	DB04
B3	23	DB03
B2	24	DB02
B1	25	DB01
B0	26	DB0
	27	SDO
SDA	28	SDA
	29	RD
SCL	30	WR(SCL)
RS	31	RS
CS	32	CS
	33	VCC
VCC	34	VCC
	35	GND
GND	36	GND
	37	LEDK4
	38	LEDK3
	39	LEDK2
LED-	40	LEDK1
LED+	41	LEDA
XR	42	XR
YD	43	YD
XL	44	XL
YU	45	YU



Appendix J: 3-Wire SPI Interface

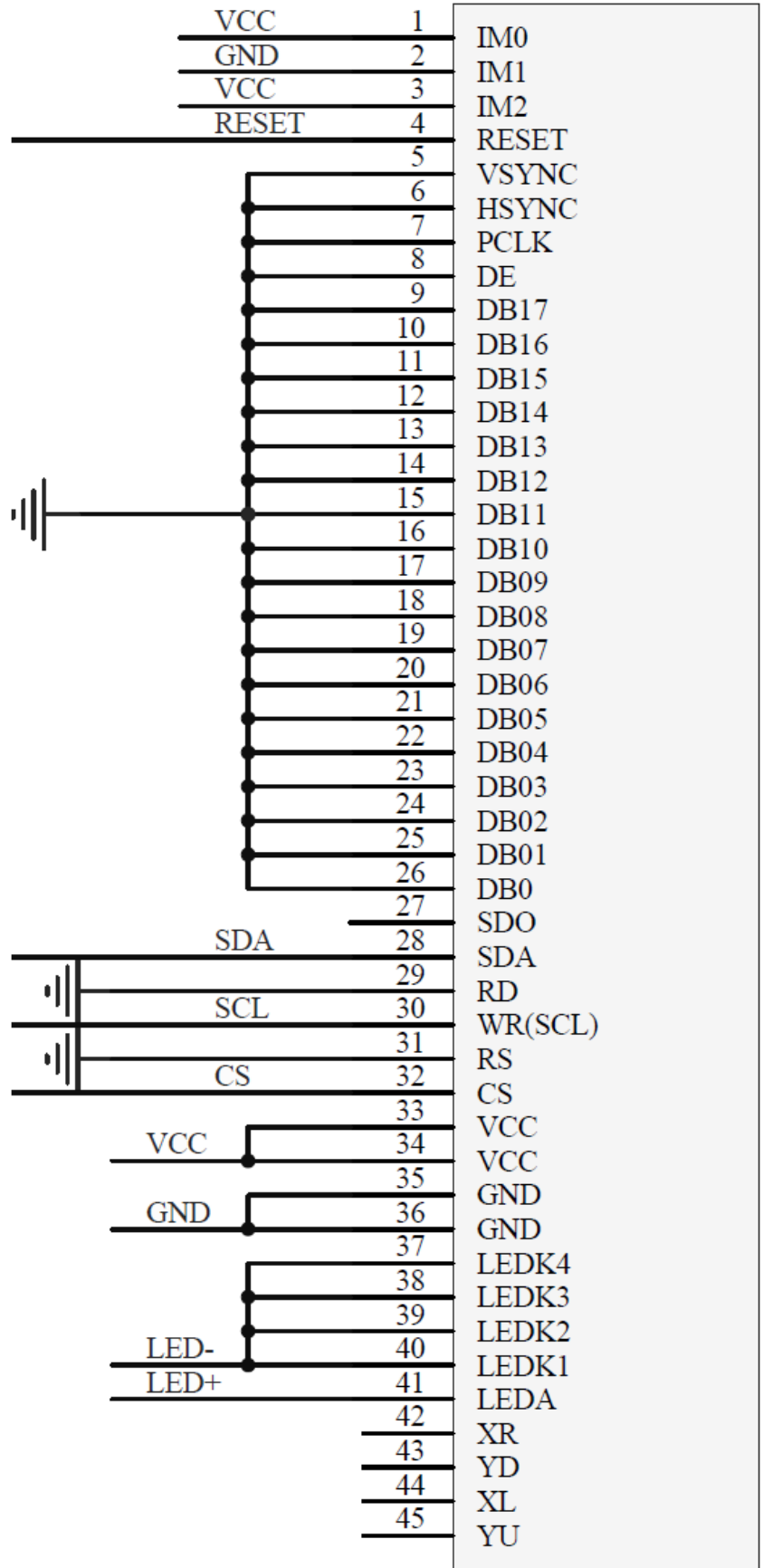



Appendix K: 4-Wire SPI Interface

