

1:1 Outline Drawing 634 Series

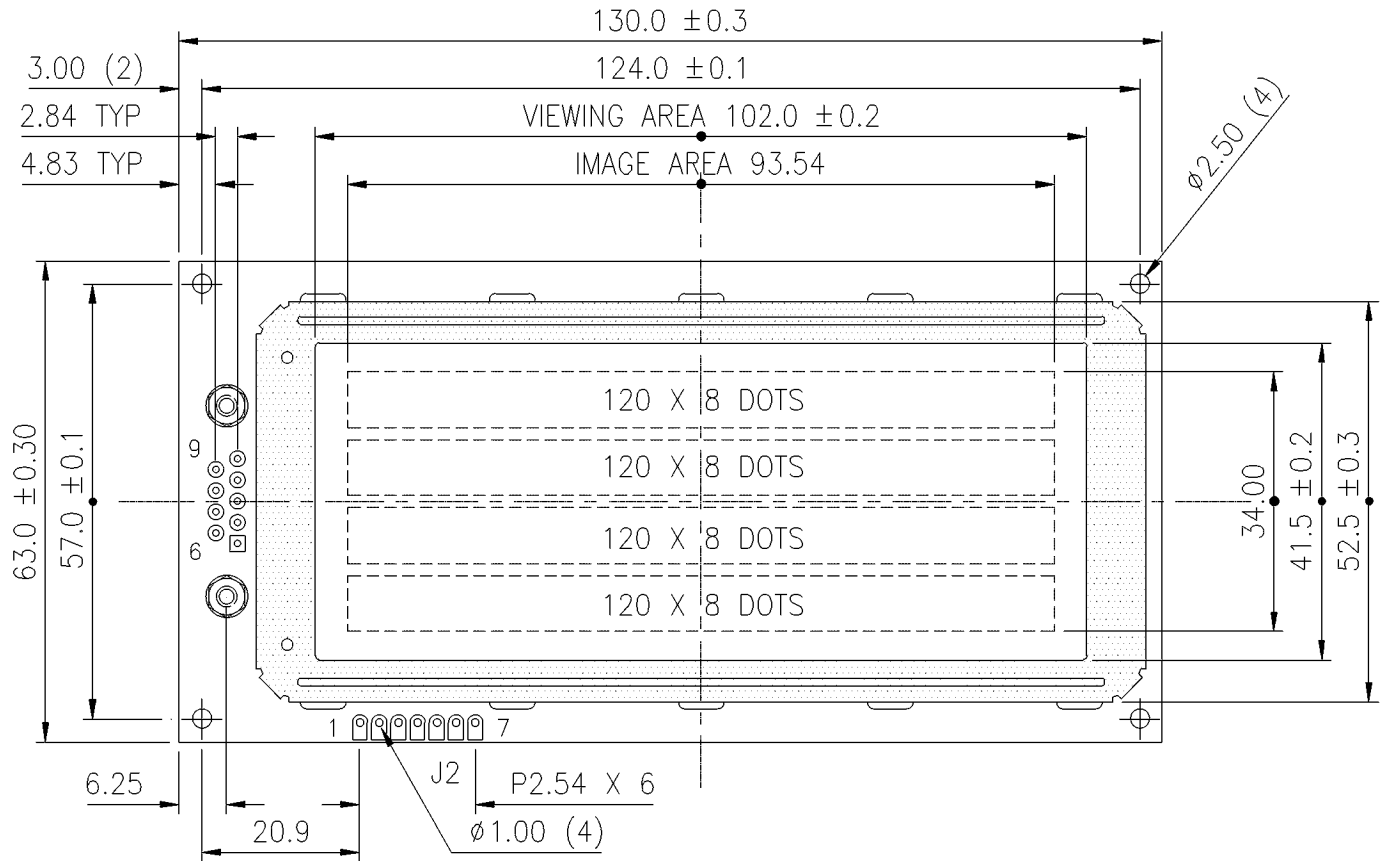

Be sure to uncheck "Fit to Page" in the Acrobat Print Dialog.
Always verify print accuracy with a physical part, or by measuring the printout.