



CrystalFontz America, Incorporated

INTELLIGENT USB LCD MODULE SPECIFICATIONS



| | |
|---------------------------|---|
| CrystalFontz Model Number | CFA632-NFG-KU |
| Hardware Version | v2.4, February 2011 |
| Firmware Version | v2.4, February 2011 |
| Data Sheet Version | v1.3, April 2011 |
| Product Pages | http://www.crystalfontz.com/product/CFA632NFGKU.html |

CrystalFontz America, Incorporated

12412 East Saltese Avenue
Spokane Valley, WA 99216-0357

Phone: 888-206-9720

Fax: 509-892-1203

Email: techinfo@crystalfontz.com

URL: www.crystalfontz.com



REVISION HISTORY

| HARDWARE | |
|------------|--|
| 2011/02/01 | <p>Current hardware version: v2.4 Previous version: v2.2 Changes:</p> <ul style="list-style-type: none">● Minor layout change on back of PCB to accommodate improved capacitors at C3, C4, and C7. The new MLCC capacitors have a longer life than the previous electrolytic capacitors.● PCB silkscreen updated to “copyright 2011”. <p>This version is fit, form, and function compatible with previous versions. For more information, see PCN 10317. Illustration of back of module is on the second page of the Module Outline Drawings (Pg. 11).</p> |
| 2011/01/05 | <p>Hardware version: v2.2 This new display module is a replacement for the obsolete CFA632-NFA-KU. The only hardware changes are these improvements:</p> <ul style="list-style-type: none">● Wide temperature range (operation -20°C to +70°C and storage -30°C to +80°C) replaces normal temperature range (operation 0°C to +50°C and storage -10°C to +60°C) .● Stainless steel bezel replaces black painted metal. The stainless steel has lower environmental impact and improves ESD protection. <p>For more information, see Part Change Notification (PCN) 10307.</p> |

| FIRMWARE | |
|------------|--|
| 2011/02/01 | <p>Current firmware version: v2.4 Firmware version displayed on the boot screen reflects hardware version “v2.4” instead of the previous “v2.2”. No changes were made to the control functions.</p> |
| 2011/01/05 | <p>Firmware version: v2.2 Firmware version displayed on the boot screen reflects hardware version v2.2. No changes were made to the control functions.</p> |



| DATA SHEET | |
|------------|---|
| 2011/04/14 | Current Data Sheet version: v1.3 Change: Wherever shown, corrected front illustration of the module. The PCB was shown rotated 180°. Dimensions have not changed. |
| 2011/03/15 | Data Sheet version: v1.2 Changes: <ul style="list-style-type: none">● Improved illustrations by removing unnecessary components and adding better descriptions. See Module Outline Drawings (Pg. 11) and Jumper Locations and Functions (Pg. 13). The module has not changed.● Added explanation for default information displayed on boot screen. See photo at the bottom of Features (Pg. 7). |
| 2011/02/24 | Data Sheet version: v1.1 Changes: <ul style="list-style-type: none">● Wherever listed, updated Hardware and Firmware revision numbers from “v2.2” to “v2.4”.● In Features, added “Factories have ISO certification”.● Added explanation of our part number system in Module Classification System.● In Physical Characteristics depth description added note an specification includes DB9 connector and USB632634 interface board. DB9 is disabled for USB interface.● In Module Outline Drawings (Pg. 11) and Jumper Locations and Functions, updated illustration of PCB back to show minor change in component layout and silkscreen.● In Set Scrolling Marquee Characters (\021, Control+U), corrected from “index determines which of the 20 scrolling marquee characters...” to “index determines which of the 16 scrolling marquee characters...” The number of characters has not changed.● Reorganized Data Sheet content in a more logical order. |
| 2011/01/11 | Data Sheet version: v1.0 First Data Sheet. |



The Fine Print

Certain applications using CrystalFontz America, Inc. products may involve potential risks of death, personal injury, or severe property or environmental damage ("Critical Applications"). CRYSTALFONTZ AMERICA, INC. PRODUCTS ARE NOT DESIGNED, INTENDED, AUTHORIZED, OR WARRANTED TO BE SUITABLE FOR USE IN LIFE-SUPPORT APPLICATIONS, DEVICES OR SYSTEMS OR OTHER CRITICAL APPLICATIONS. Inclusion of CrystalFontz America, Inc. products in such applications is understood to be fully at the risk of the customer. In order to minimize risks associated with customer applications, adequate design and operating safeguards should be provided by the customer to minimize inherent or procedural hazard. Please contact us if you have any questions concerning potential risk applications.

CrystalFontz America, Inc. assumes no liability for applications assistance, customer product design, software performance, or infringements of patents or services described herein. Nor does CrystalFontz America, Inc. warrant or represent that any license, either express or implied, is granted under any patent right, copyright, or other intellectual property right of CrystalFontz America, Inc. covering or relating to any combination, machine, or process in which our products or services might be or are used.

The information in this publication is deemed accurate but is not guaranteed.

Company and product names mentioned in this publication are trademarks or registered trademarks of their respective owners.

Copyright © 2011 by CrystalFontz America, Inc., 12412 East Saltese Avenue, Spokane Valley, WA 99216-0357 U.S.A.



CONTENTS

| | |
|--|-----------|
| MAIN FEATURES | 7 |
| Features | 7 |
| Module Classification System | 8 |
| Module Comparison | 8 |
| MECHANICAL SPECIFICATIONS | 10 |
| Physical Characteristics | 10 |
| Temperature and Humidity Ratings | 10 |
| Module Outline Drawings | 11 |
| Jumper Locations and Functions | 13 |
| OPTICAL CHARACTERISTICS | 14 |
| ELECTRICAL SPECIFICATIONS | 15 |
| System Block | 15 |
| Required Voltage: | 15 |
| Current Consumption: | 15 |
| Electrostatic Discharge (ESD) | 15 |
| USB CONNECTION | 16 |
| HOST COMMUNICATIONS | 16 |
| CFA632 Demonstration and Test Programs | 16 |
| About Handshaking | 16 |
| Control Codes and Functions | 17 |
| Description of Control Functions | 18 |
| Cursor Home (\001, Control+A) | 18 |
| Hide Display (\002, Control+B) | 18 |
| Restore Display (\003, Control+C) | 18 |
| Hide Cursor (\004, Control+D) | 18 |
| Show Underline Cursor (\005, Control+E) | 18 |
| Show Blinking Block Cursor with Underscore (\006, Control+F) | 18 |
| Show Inverting Blinking Block Cursor with Underscore (\007, Control+G) | 18 |
| Backspace (\008, Control+H) | 18 |
| Control the Boot Screen (\009, Control+I) | 18 |
| Line Feed (\010, Control+J or Control+Enter) | 20 |
| Delete In Place (\011, Control+K) | 20 |
| Form Feed (\012, Control+L) | 20 |
| Carriage Return (\013, Control+M) | 20 |
| Backlight Control (\014, Control+N) | 20 |
| Contrast Control (\015, Control+O) | 20 |
| Set Cursor Position (Column and Row) (\017, Control+Q) | 21 |
| Horizontal Bar Graph (\018, Control+R) | 21 |
| Scroll ON (\019, Control+S) | 22 |
| Scroll OFF (\020, Control+T) | 22 |
| Set Scrolling Marquee Characters (\021, Control+U) | 22 |
| Enable Scrolling Marquee (\022, Control+V) | 23 |
| Wrap ON (\023, Control+W) | 24 |



CONTENTS, CONTINUED

| | |
|--|-----------|
| Wrap OFF (\024, Control+X) ----- | 24 |
| Set Custom Character Bitmap (\025, Control+Y) ----- | 25 |
| Reboot (\026, Control+Z) ----- | 26 |
| Escape Sequence Prefix (\027, Escape) ----- | 26 |
| Reserved (\028, Control+Backslash) ----- | 27 |
| Send Data Directly to the LCD Controller (\030, Control+Equal) ----- | 27 |
| Show Information Screen (\031, Control+Minus) ----- | 27 |
| CHARACTER GENERATOR ROM (CGROM) ----- | 28 |
| MODULE RELIABILITY AND LONGEVITY ----- | 29 |
| Module Reliability ----- | 29 |
| Module Longevity (EOL / Replacement Policy) ----- | 29 |
| CARE AND HANDLING PRECAUTIONS ----- | 30 |
| APPENDIX A: QUALITY ASSURANCE STANDARDS ----- | 32 |

LIST OF FIGURES

| | |
|---|----|
| Figure 1. Module Outline Drawings (two pages) ----- | 11 |
| Figure 2. CFA632 Jumper Locations and Functions ----- | 13 |
| Figure 3. Definition of 6:00 O'clock and 12:00 O'clock Viewing Angles ----- | 14 |
| Figure 4. CFA632 System Block Diagram ----- | 15 |
| Figure 5. Location of USB Slot on USB632634 Interface Board ----- | 16 |
| Figure 6. CFA632 Character Generator ROM (CGROM) ----- | 28 |



MAIN FEATURES

FEATURES

- 16x2 LCD has a large display area in a compact 108 mm x 42 mm (4.25" x 1.65") package.
- Modules are thin: depth is 15.9 mm (0.626") including DB9 connector and USB interface board.
- Large, easy-to-read characters: 7.3 mm (0.287") character height.
- CFA632-NFG-KU is
 - Reflective, no backlight.
 - FSTN positive mode LCD displays dark characters on light background. Needs ambient light to be visible).
 - Sunlight readable.
- Software controlled contrast.
- The CGROM is an enhanced version with many useful characters: numeric superscripts, icons, mathematical symbols, some fractions, a great variety of arrows, many currency symbols, and more.
- LCD characters are contiguous horizontally to allow the host software to display "gapless" bar graphs in horizontal direction.
- Software controlled terminal style automatic scrolling and line wrapping.
- Unique scrolling marquee feature continuously scrolls a message across the display without host intervention.
- Buffered communication.
- Optional 5.25" half-height drive-bay [CFA632 PC Mounting Bracket](#) available.
- Nonvolatile memory capability (EEPROM) to customize the "power-on" display settings. All features of the display are controlled: characters displayed, user-definable characters, backlight setting, contrast setting, cursor position, cursor style, "wrap" setting, "scroll" setting, and even the scrolling marquee.
- Extended voltage (9-15 volts) and 5 volts power inputs standard on all modules for the controller. Backlight is 5 volts only.
- RoHS compliant.
- Factories have ISO certification.

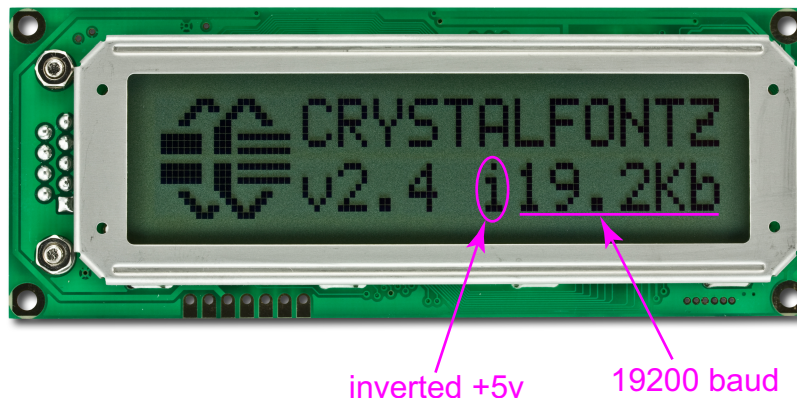



MODULE CLASSIFICATION SYSTEM

CFA
 632
 -
 N
 F
 G
 -
 K
 U

| | | |
|---|---|--|
| ① | Brand | CrystalFontz America, Inc. |
| ② | Model Identifier | 632 |
| ③ | Backlight Type & Color | N – no backlight |
| ④ | Fluid Type, Image (positive or negative), & LCD Glass Color | F – FSTN, negative neutral |
| ⑤ | Polarizer Film Type, Temperature Range, & View Angle (O 'Clock) | G – Reflective, Wide Temperature Range ¹ , 6:00 |
| ⑥ | Special Code 1 | K – manufacturer's code |
| ⑦ | Special Code 2 | U – USB interface |
| ¹ Wide Temperature Range is -20°C minimum to +70°C maximum | | |

MODULE COMPARISON

The tables below list the part numbers for the obsolete CFA632 hardware series v2.2 and the new replacement series v2.4. All hardware dimensions, mounting holes, and connector locations are the same. For more information, see [Part Change Notification \(PCN\) 10307](#).

| A, no shading = Available: samples 1st quarter 2011, in volume 2nd quarter 2011. O, gray shading = Obsolete. Will become obsolete when stock is depleted. | | | | | | Temp = Wide Temperature Range or Normal Temperature Range | | |
|--|-------------|-------|-----------------|-------|-----------|---|------|-----------|
| A/O | PART NUMBER | FLUID | LCD GLASS COLOR | IMAGE | POLARIZER | BEZEL | TEMP | BACKLIGHT |

Dark (Near-Black) Characters on Light-Gray Background

CFA632-NFG-KS & CFA632-NFG-KU photo:



| | | | | | | | | |
|---|-------------------------------------|------|---------|----------|------------|---------------------|--------|--------------|
| A | CFA632-NFG-KS ("full swing" RS-232) | FSTN | neutral | positive | reflective | stainless steel | Wide | no backlight |
| A | CFA632-NFG-KU (USB) | | | | | black painted metal | Normal | |
| O | CFA632-NFA-KS ("full swing" RS-232) | | | | | | | |
| O | CFA632-NFA-KU (USB) | | | | | | | |



| | |
|--|---|
| A, no shading = Available: samples 1st quarter 2011, in volume 2nd quarter 2011. | Temp = Wide Temperature Range or Normal Temperature Range |
| O, gray shading = Obsolete. Will become obsolete when stock is depleted. | |

| A/O | PART NUMBER | FLUID | LCD GLASS COLOR | IMAGE | POLARIZER | BEZEL | TEMP | BACKLIGHT |
|-----|-------------|-------|-----------------|-------|-----------|-------|------|-----------|
|-----|-------------|-------|-----------------|-------|-----------|-------|------|-----------|

Yellow-Green Characters on Dark (Near-Black) Background CFA632-YDI-KS & CFA632-YDI-KU photo:



| | | | | | | | | |
|---|-------------------------------------|-------|-------|----------|--------------|---------------------|--------|-------------------------|
| A | CFA632-YDI-KS ("full swing" RS-232) | FFSTN | black | negative | transmissive | stainless steel | Wide | yellow-green array LEDs |
| A | CFA632-YDI-KU (USB) | | | | | | | |
| O | CFA632-YMC-KS ("full swing" RS-232) | STN | blue | | | black painted metal | Normal | |
| O | CFA632-YMC-KU (USB) | | | | | | | |

Dark (Near-Black) Characters on Yellow-Green Background CFA632-YFH-KS & CFA632-YFH-KU photo:



| | | | | | | | | |
|---|-------------------------------------|------|---------|----------|---------------|---------------------|--------|-------------------------|
| A | CFA632-YFH-KS ("full swing" RS-232) | FSTN | neutral | positive | transflective | stainless steel | Wide | yellow-green array LEDs |
| A | CFA632-YFH-KU (USB) | | | | | | | |
| O | CFA632-YFB-KS ("full swing" RS-232) | | | | | black painted metal | Normal | |
| O | CFA632-YFB-KU (USB) | | | | | | | |



MECHANICAL SPECIFICATIONS

PHYSICAL CHARACTERISTICS

| ITEM | SIZE (mm) |
|----------------|---|
| Overall Size | 108 (W) x 42 (H) millimeters |
| Viewing Area | 82.3 (W) x 22.5 (H) millimeters |
| Active Area | 74.82 (W) x 15.8 (H) millimeters |
| Character Size | 3.9 (W) x 6.38 (H) millimeters |
| Dot Size | 0.72 (W) x 0.86 (H) millimeters |
| Dot Pitch | 0.78 (W) x 0.92 (H) millimeters |
| Depth | 15.9 millimeters (Includes DB9 connector and USB632634 interface board. DB9 is disabled for USB interface.) |
| Weight | 56 grams (typical) |

TEMPERATURE AND HUMIDITY RATINGS

| | SYMBOL | MINIMUM | MAXIMUM |
|---------------------------------|-----------------|---------|---------|
| ABSOLUTE MAXIMUM RATINGS | | | |
| Operating Temperature | T _{OP} | -20°C | +70°C |
| Storage Temperature | T _{ST} | -30°C | +80°C |
| Humidity Range (noncondensing) | RH | 10% | 90% |



MODULE OUTLINE DRAWINGS

Figure 1. Module Outline Drawings (two pages)

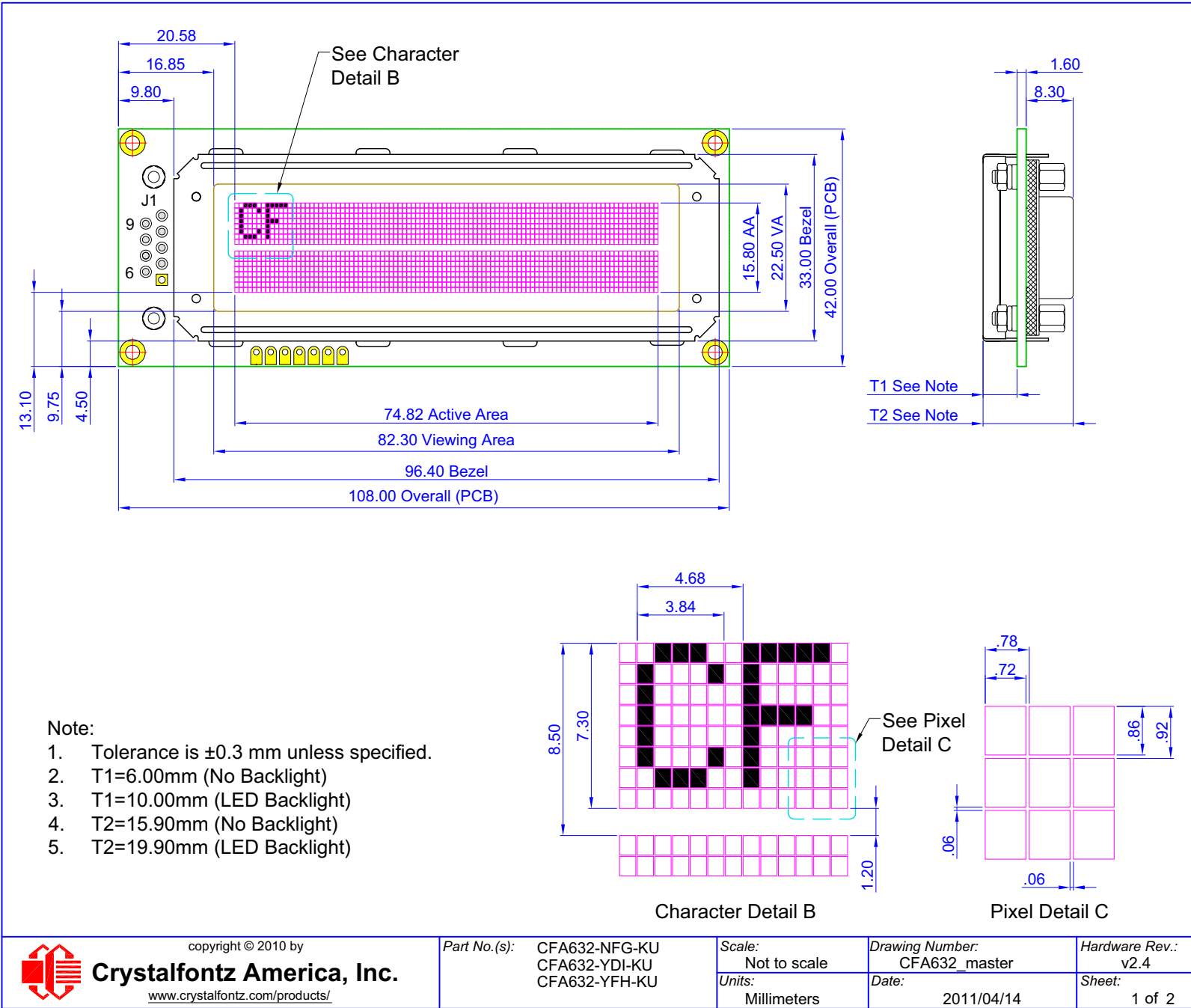

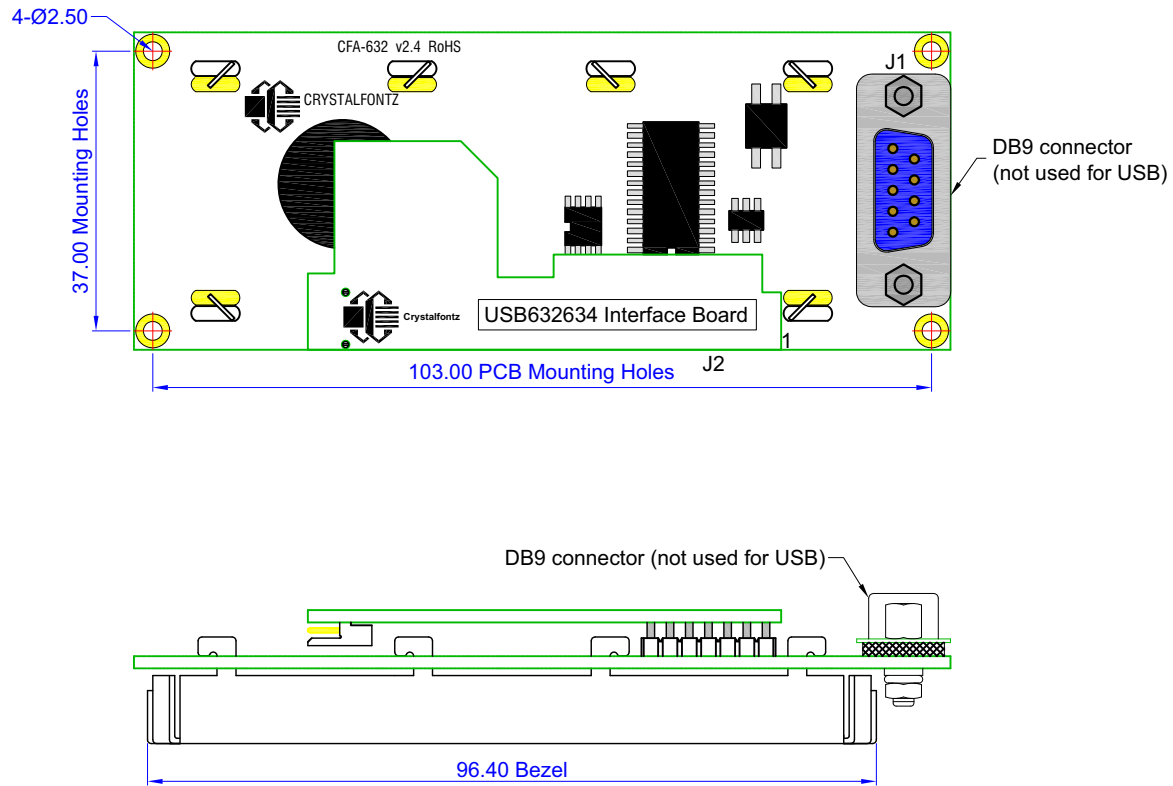

Note: Tolerance is ± 0.3 mm unless specified.



Crystalfontz America, Inc.

www.crystalfontz.com/products/

copyright © 2010 by

Part No.(s): CFA632-NFG-KU
 CFA632-YDI-KU
 CFA632-YFH-KU

Scale:
 Not to scale
 Units:
 Millimeters

Drawing Number:
 CFA632_master
 Date:
 2011/03/10

Hardware Rev.:
 v2.4
 Sheet:
 2 of 2



JUMPER LOCATIONS AND FUNCTIONS

The CFA634 has seven jumpers. The jumpers are normally open. Two jumpers may be closed by melting a ball of solder across their gap. Do not close any of the other jumpers. You may re-open the two jumpers by removing the solder. (Solder wick works well for this.)

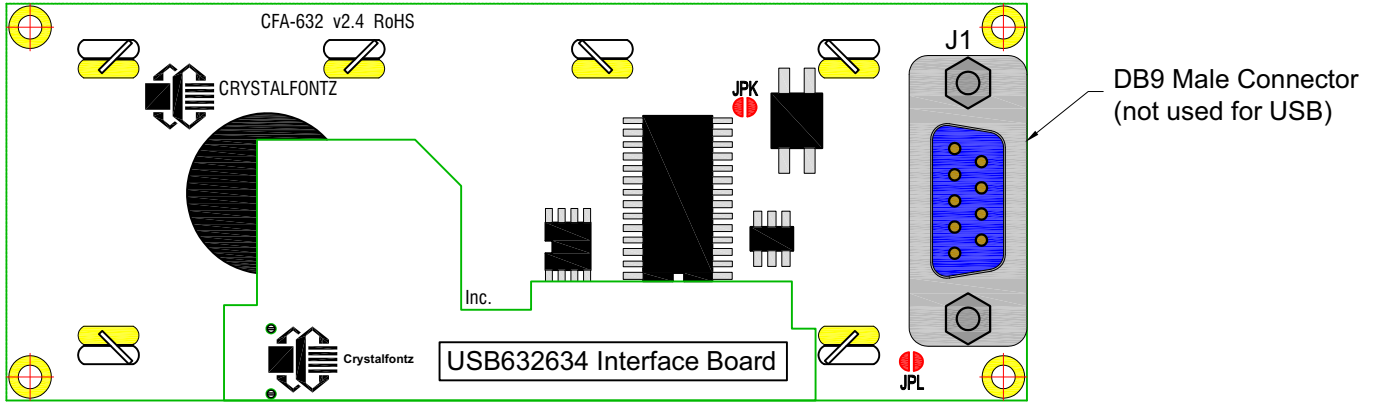

| | | |
|-----|-----------------------|--|
| JPK | open closed | Show splash screen (Logo) Disable splash screen (Logo) |
| JPL | open closed | Frameground* is open Frameground is connected to Signal/Power supply Ground |

*Frameground is a trace connecting the mounting holes, bezel, and shell of the DB9.

NOTE: Do not change other jumpers

Figure 2. CFA632 Jumper Locations and Functions



OPTICAL CHARACTERISTICS

| | |
|-------------------|-----------|
| Viewing Direction | 6 o'clock |
|-------------------|-----------|

Definition of 6 O'clock and 12:00 O'clock Viewing Angles

This LCD module has a 6:00 o'clock viewing angle. A 6:00 o'clock viewing angle is a bottom viewing angle like what you would see when you look at a cell phone or calculator. A 12:00 o'clock viewing angle is a top viewing angle like what you would see when you look at the gauges in a golf cart or airplane.

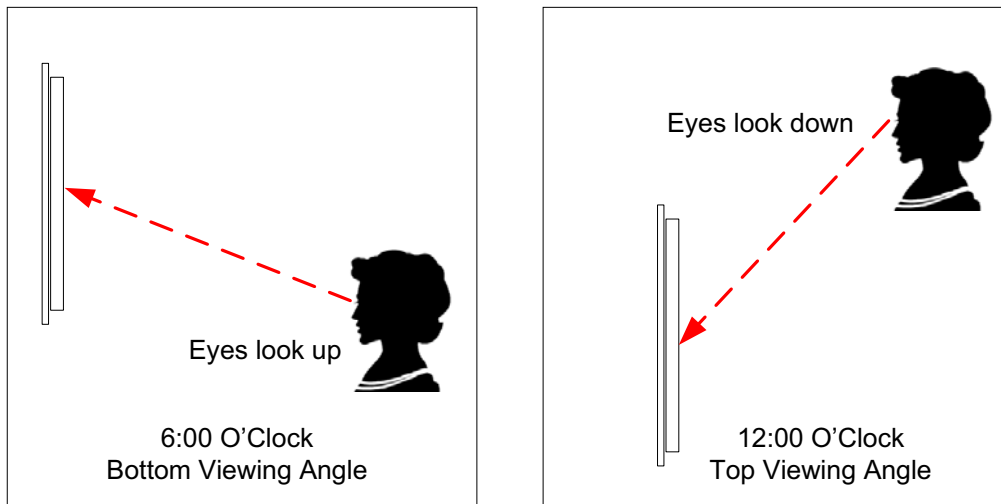

Figure 3. Definition of 6:00 O'clock and 12:00 O'clock Viewing Angles



ELECTRICAL SPECIFICATIONS

SYSTEM BLOCK

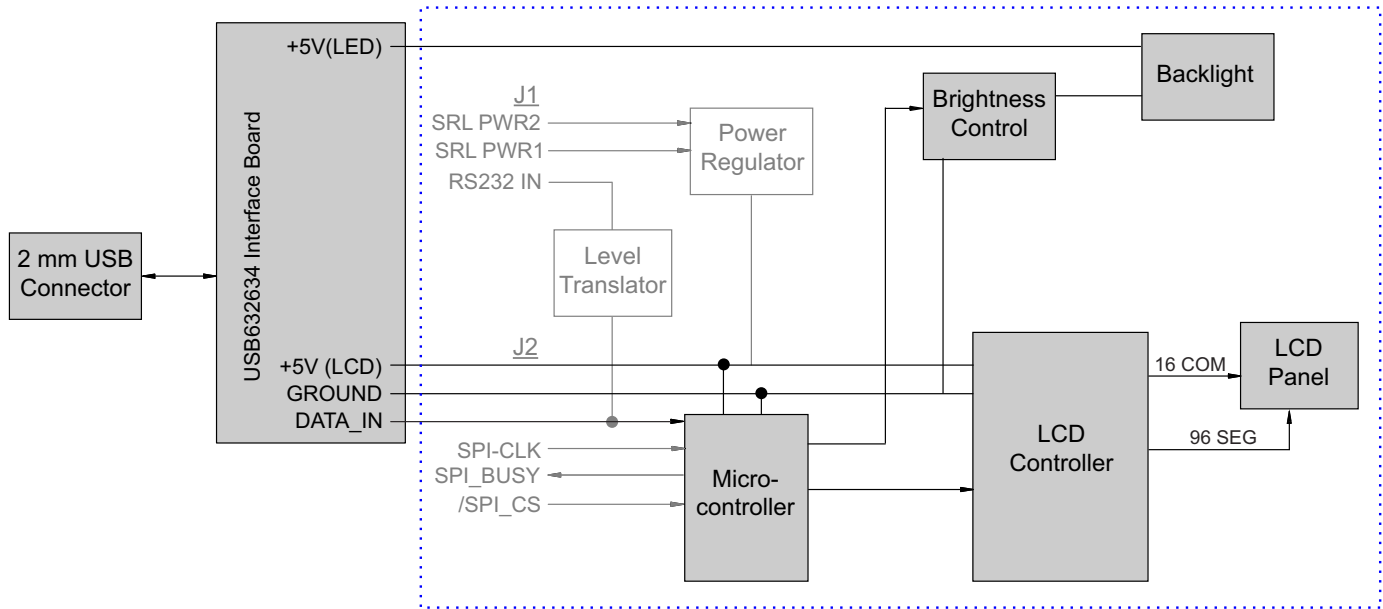

Figure 4. CFA632 System Block Diagram

| CRITERIA | SPECIFICATION |
|-------------------------|-------------------------|
| Backlight PWM Frequency | 300 Hz nominal |
| Driving Method | 1/ 32 Duty, 1/ 6.7 Bias |

REQUIRED VOLTAGE:

Logic (+5 volts): Supplied through DB9 connector using the on-board regulator: 9 volts minimum, 15 volts maximum

CURRENT CONSUMPTION:

Overall module current (LCD + backlight at 100%): 380 mA

Overall module current (LCD + backlight at 0%): 9 mA

ELECTROSTATIC DISCHARGE (ESD)

The circuitry is industry standard CMOS logic and susceptible to ESD damage. Please use industry standard antistatic precautions as you would for any other static sensitive devices such as expansion cards, motherboards, or integrated circuits. Ground your body, work surfaces, and equipment.



USB CONNECTION

The CFA632-NFG-KU module consists of a CFA632-NFG-KS and the USB632634 interface board mounted on the back of the PCB. Looking at the back of the module, the USB slot is on the bottom of the interface board.

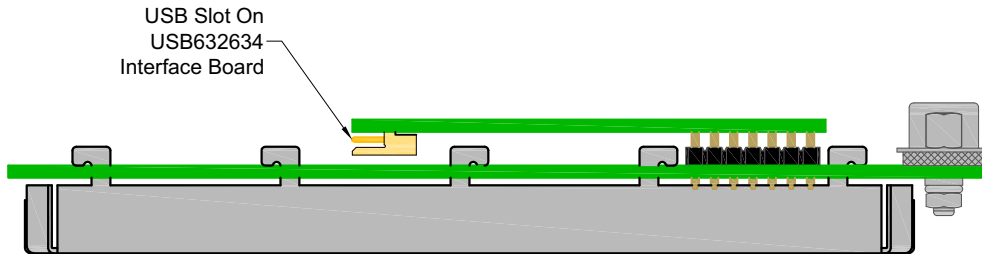

Figure 5. Location of USB Slot on USB632634 Interface Board

Two Crystalfontz choices for USB cables are [WR-USB-Y03](#) and [WR-USB-Y11](#).

HOST COMMUNICATIONS

CFA632 DEMONSTRATION AND TEST PROGRAMS

The following programs are available for free download on our website:

- [WinTest Test and Demonstration Software for CFA632 and CFA634](#)
This website page has a link to download a demonstration and test program, WinTest.exe. The C source code is included. The program demonstrates software techniques for displaying banners, graphs, large digits, spectrum, and oscilloscope. Example commands may be copied from the Control Codes listed below and pasted into WinTest. (See [Description of Control Functions \(Pg. 18\)](#)).
- [632/634 BasicStamp2 Sample](#)
This website page has a link to download a simple program that demonstrates communications from a Parallax Basic Stamp. BS2 source code is available.
- [632/634 Linux-Compatible Command-Line Demonstration Program](#)
This is a link to a Linux-compatible demonstration program. The C source code is included.

ABOUT HANDSHAKING

- The display can generally execute commands faster than the interface can deliver them so no handshaking is necessary from the display's point of view.
- The few exceptions involve accessing the EEPROM (For example, see [Control the Boot Screen \(\009, Control+l\) \(Pg. 18\)](#)).



CONTROL CODES AND FUNCTIONS

The CFA632 will accept plain ASCII characters and display them on the screen at the current cursor position. For example, if you send "Hello World", the display shows "Hello World". The display also supports a set of control characters that access other features of the display. Some of these commands require one or more parameters. In general, the parameters are "binary" characters, meaning that any value between 0 and 255 may be required.

The notation "\xxx" is used for "binary" data, where "xxx" is the decimal representation of the number. Use the codes \000 to \255 to include all possible values for a character. This notation is supported by the [WinTest Test and Demonstration Software](#). We recommend you try this utility by using the examples listed under [Description of Control Functions \(Pg. 18\)](#). Select a line of text by highlighting it, copy it, then paste it into the WinTest edit box with a right-click "Paste". Be sure *not* to highlight the invisible carriage return at the end of the line.

Below is a list of the control codes. Click on the links under the ASCII column to jump to an explanation of the code.

| ASCII | KEYSTROKES | CONTROL CODE FUNCTION |
|----------------------|------------------------------------|--|
| \000 | Control+@ | Reserved |
| \001 | Control+A | Cursor Home |
| \002 | Control+B | Hide Display |
| \003 | Control+C | Restore Display |
| \004 | Control+D | Hide Cursor |
| \005 | Control+E | Show Underline Cursor |
| \006 | Control+F | Show Blinking Block Cursor with Underscore |
| \007 | Control+G | Show Inverting Blinking Block Cursor with Underscore |
| \008 | Control+H | Backspace (Destructive) |
| \009 | Control+I | Control the Boot Screen |
| \010 | Control +J or Control +Enter | Line Feed |
| \011 | Control+K | Delete In Place |
| \012 | Control+L | Form Feed (Clear Display) |
| \013 | Control+M | Carriage Return |
| \014 | Control+N | Backlight Control |
| \015 | Control+O | Contrast Control |
| \016 | Control+P | (Reserved) |
| \017 | Control+Q | Set Cursor Position (Column and Row) |
| \018 | Control+R | Horizontal Bar Graph |

| ASCII | KEYSTROKES | CONTROL CODE FUNCTION |
|----------------------|--------------------|--------------------------------------|
| \019 | Control+S | Scroll ON |
| \020 | Control+T | Scroll OFF |
| \021 | Control+U | Set Scrolling Marquee Characters |
| \022 | Control+V | Enable Scrolling Marquee |
| \023 | Control+W | Wrap ON |
| \024 | Control+X | Wrap OFF |
| \025 | Control+Y | Set Custom Character Bitmap |
| \026 | Control Z | Reboot |
| \027 | Escape | Escape Sequence Prefix |
| \028 | Control+ Backslash | (Reserved) |
| \029 | Control+Quote | (Reserved) |
| \030 | Control+Equal | Send Data Directly to LCD Controller |
| \031 | Control+Minus | Show Information Screen |
| \128 | | Custom Character 0 |
| \129 | | Custom Character 1 |
| \130 | | Custom Character 2 |
| \131 | | Custom Character 3 |
| \132 | | Custom Character 4 |
| \133 | | Custom Character 5 |
| \134 | | Custom Character 6 |
| \135 | | Custom Character 7 |



DESCRIPTION OF CONTROL FUNCTIONS

Cursor Home (\001, Control+A)

Moves cursor to the top left character position. No data is changed. Identical to Control+Q,0,0.

Hide Display (\002, Control+B)

Display is blanked, no data is changed.

Restore Display (\003, Control+C)

Restores blanked display; nothing else is changed.

Hide Cursor (\004, Control+D)

Cursor is not shown; nothing else is changed.

Show Underline Cursor (\005, Control+E)

Shows a nonblinking underline cursor at the printing location.

Show Blinking Block Cursor with Underscore (\006, Control+F)

Shows a blinking block cursor at the printing location.

Show Inverting Blinking Block Cursor with Underscore (\007, Control+G)

Shows a blinking block cursor at the printing location. This cursor inverts the character rather than replacing the character with a block. This cursor style is the default cursor at power-up.

Backspace (\008, Control+H)

Moves the cursor back one space and erases the character in that space. Will wrap from the left-most column to the right-most column of the line above. Will wrap from the left-most column of the top row to the right-most column of the bottom row.

Control the Boot Screen (\009, Control+I)

This command allows the current state of the display to be stored in the display's EEPROM, recalling of the EEPROM contents to the display, and controlling the boot behavior.

All features of the display are controlled: the characters displayed, the bitmaps of the user-definable characters, the backlight setting, the contrast setting, the cursor position, the cursor style, the wrap setting, the scroll setting, and even the scrolling marquee's data and state.



NOTE

Since writing and reading the EEPROM takes quite a bit time, it is possible to overflow the display's input buffer if data is continuously sent while the display is busy executing these commands. The display will still buffer data while these commands are being executed. However, the buffer is 64 bytes long and can be overflowed. You must take care to not overflow the input buffer while the EEPROM commands are executing.

Send "Control+I" followed by the command.

\009 \000 Set boot to "backward compatibility mode"

Execution time: 5.1 mS

If JPK is open: Crystalfontz boot screen is displayed. The boot screen will clear automatically after about 5 seconds. If a character is received during that 5 seconds, the boot screen will be cleared immediately, then that character will be processed.

If JPK is closed: No logo is shown.

\009 \001 Set boot to show Crystalfontz logo until a character arrives

Execution time: 5.1 mS

The Crystalfontz boot screen is displayed. When a character is received, the boot screen will be cleared immediately and the character will be processed.

\009 \002 Set boot to show User Boot Screen for 5 seconds

Execution time: 5.1 mS

The User Boot Screen is recalled from the EEPROM and shown on the display. The boot screen will clear automatically after about 5 seconds. If a character is received during that 5 seconds, the boot screen will be cleared immediately, then that character will be processed.

\009 \003 Set boot to show User Boot Screen until a character arrives

Execution time: 5.1 mS

The User Boot Screen is recalled from the EEPROM and shown on the display. When a character is received, the boot screen will be cleared immediately, then that character will be processed.

\009 \004 Set boot to show User Boot Screen and leave it displayed

Execution time: 5.1 mS

The User Boot Screen is recalled from the EEPROM and shown on the display. Incoming characters are processed normally without the screen being cleared. Settings for display blank, cursor style and position, WRAP, SCROLL are maintained.

\009 \005 Save current display state to EEPROM

Execution time: 800 mS

The entire display state is saved to the EEPROM.



\009 \006 Recall current display state from EEPROM

Execution time: 91 mS

The entire display state is recalled from the EEPROM

Line Feed (\010, Control+J or Control+Enter)

Moves the cursor down one row. If SCROLL is on and the cursor is at the bottom row, the display will scroll up one row and the bottom row will be cleared. If SCROLL is off, and the cursor is at the bottom row, it will wrap up to the same character position on the top row.

NOTE

If SCROLL is set, the cursor is placed on the bottom line, several Line Feed characters are sent (forcing the display to scroll), and these Line Feeds characters are immediately followed by a burst of more than 64 additional characters—it is possible to overflow the display's input buffer. Don't do this. Contrary to design standards for internet server software from our favorite software monopoly, the display will not start executing the input buffer data as if it were code. The display will simply overwrite the oldest data in the input buffer with the most recently received data.

Delete In Place (\011, Control+K)

Deletes the character at the current cursor position. Cursor is not moved.

Form Feed (\012, Control+L)

Clears the display and returns cursor to Home position (upper left). All data is erased.

Carriage Return (\013, Control+M)

Moves cursor to the left-most column of the current row.

Backlight Control (\014, Control+N)

Send "Control+N", followed by a byte from 0-100 for the backlight brightness. 0=OFF, 100=ON, intermediate values will vary the brightness.

Examples:

```
\014\000  
\014\050  
\014\100
```

Contrast Control (\015, Control+O)

Send "Control+O", followed by a byte from 0-100 for the contrast setting of the displayed characters.

0 = very light 50 is typical 100 = very dark

Examples:

```
\015\050  
\015\060  
\015\070
```



Reserved (\16, Control+P)

Set Cursor Position (Column and Row) (\017, Control+Q)

Send "Control+Q" followed by one byte for the column (0-15), and a second byte for the row (0-1). The upper-left position is 0,0. The lower-right position is 15,1.

For example, to move the cursor to column 11 of the second line:

```
\017\010\001
```

Horizontal Bar Graph (\018, Control+R)

Send "Control+R" followed by the following bytes:

```
graph_index  

style  

start_column  

end_column  

length  

row
```

graph_index determines which custom characters are used.

| <i>graph_index</i> | CUSTOM CHARACTERS USED |
|--------------------|------------------------|
| \000 | 0,1 |
| \001 | 2,3 |
| \002 | 4,5 |
| \003 | 6,7 |

style is the bit pattern to use in drawing the graph.

| <i>style</i> | PATTERN | DESCRIPTION |
|--------------|-------------|-----------------------------------|
| \255 | (11111111b) | thick bar |
| \000 | (00000000b) | not visible (all pixels are off) |
| \085 | (01010101b) | striped bar |
| \060 | (00111100b) | medium width bar, centered |
| \015 | (00001111b) | medium width bar, low in the row |
| \240 | (11110000b) | medium width bar, high in the row |

Any value is valid between \000 and \255. The MSB (Most Significant Bit) is at the top of the row, the LSB (Least Significant Bit) is at the bottom of the row.



start_column and **end_column** are the character X coordinates of the graph area. Each must be between \000 and \015. **start_column** must be less than or equal to **end_column**.

length is the length in pixels of the graph. Positive values will graph from the left edge of **start_column**, negative values will graph from the right edge of **end_column**. There are six pixels per character, so the maximum value of **length** is $16 \times 6 = \backslash096$.

row is the character Y coordinate. \000-\001 is valid.

Examples:

```
\018\000\255\000\014\010\001
\018\000\015\000\014\236\001
```

NOTE

The entire graph area is completely rewritten by each graph command, so there is no need to clear the area between successive updates of the same graph. If a length of \000 is written, the entire graph area is cleared to spaces. Negative values can be calculated as $256 - \text{value}$. For instance, if you want a graph to extend 20 pixels towards the left, from the right most column of the graph area, send 236 ($256 - 20 = 236$). No additional graph "setup" command is needed.

NOTE

The graphs use some of the custom characters and may corrupt the display contents if there are user-defined custom characters or large numbers shown.

Scroll ON (\019, Control+S)

Turns scroll feature on. Then a Line Feed (Control+J) command from the bottom row will scroll the display up by one row, independent of Wrap. If Wrap is also on (Control+W), a wrap occurring on the bottom row will cause the display to scroll up one row. Scroll is on at power-up.

Scroll OFF (\020, Control+T)

Turns scroll feature off. Then a Line Feed (Control+J) command from the bottom row will move the cursor to the top row of the same column, independent of wrap (Control+W for Wrap ON, Control+X for Wrap OFF). If wrap is on, a wrap occurring on the bottom row will also wrap vertically to the top row. Scroll is on at power-up.

Set Scrolling Marquee Characters (\021, Control+U)

Send "Control+U" followed by the following bytes:

index
character

index determines which of the 16 scrolling marquee characters gets set (\000 to \015 are valid).

character is the value that this position in the scrolling marquee will be set to.

The examples below will set the first 12 characters to "CrystalFontz", put another message on the display, and enable the scrolling marquee. Please note that the second line ends in a space.



Examples:

```
\004\022\255\001\005\012\017\000\001Scrolling Marquee
\021\000c\021\001r\021\002y\021\003s\021\004t\021
\005a\021\006l\021\007f\021\008o\021\009n\021\010t
\021\011z\021\012 \021\013 \021\014 \021\015 \021
\016 \021\017 \021\018 \021\019 \022\001\001\016
```

NOTE

A section of memory holds 20 hidden characters. These 20 characters, along with the contents of one line of the display, can be rotated pixel by pixel across the display in a circular fashion. Use this command multiple times to set the 20 hidden characters. Use the normal display functions to set the other characters in the line you want to rotate and then enable rotation with [Enable Scrolling Marquee](#) command. The hidden characters are set to blanks at power-up, or loaded from the User Boot Screen.

You will probably want to disable the scrolling marquee movement while you are setting the scrolling marquee characters or modifying characters on the rotating line. You will probably also want to move the cursor off the line or hide it.

WinTest, available at [WinTest Test and Demonstration Software](#) easily allows setting up the scrolling marquee and adjusting the parameters, so you can find a setting you like in a minimum amount of time.

NOTE

If the scrolling banner is saved as the default boot state, one of the characters will be overwritten with a blank. The character overwritten depends on the position of the banner when the [Control the Boot Screen \(\009, Control+I\) \(Pg. 18\)](#) command is sent. This error affects all firmware versions.

Enable Scrolling Marquee (\022, Control+V)

Send "Control+V" followed by the following bytes:

```
line
scroll_step_size
update_speed
```

line determines which line will scroll with the scrolling marquee or if the scrolling marquee is disabled.

| <i>line</i> | FUNCTION |
|-------------|---|
| \000 | enable scrolling marquee on line 1 |
| \001 | enable scrolling marquee on line 2 |
| \255 | disable scrolling marquee (valid values for <i>scroll_step_size</i> and <i>update_speed</i> must still be sent) |



scroll_step_size controls the number of pixels that the message is shifted by at each update:

| scroll_step_size | RESULT |
|-------------------------|--|
| \001 | shift by one pixel, smooth but slow |
| \002 | shift by two pixels |
| \003 | shift by three pixels |
| \004 | shift by four pixels |
| \005 | shift by five pixels |
| \006 | shift by six pixels (equal to shifting by one character, fast) |

update_speed determines how often updates will occur. The units are 1/96 of a second (about 10 mS). The valid range is \005 (52 mS) to \100 (1.042 S).

NOTE

Since the liquid crystal fluid in the display takes some time to react, the minimum usable value is about 16 or 167 mS. The Enable Scrolling Marquee command supports a large range of speeds to accommodate future displays and user preference.

The following equations will allow you to determine the speed at which the message scrolls:

$$\begin{aligned}\text{Update Frequency} &= \text{update_speed} / 96 \text{ Hz} \\ \text{Update Period} &= 96 / \text{update_speed} \text{ Seconds}\end{aligned}$$

$$\begin{aligned}\text{New Character Frequency} &= (\text{scroll_step_size} \times \text{update_speed}) / (96 \times 6) \text{ Hz} \\ \text{New Character Period} &= (96 \times 6) / (\text{scroll_step_size} \times \text{update_speed}) \text{ Seconds}\end{aligned}$$

$$\text{Message Repeat Period} = (36 \times 96 \times 6) / (\text{scroll_step_size} \times \text{update_speed}) \text{ Seconds}$$

See the example in [Set Scrolling Marquee Characters \(\021, Control+U\) \(Pg. 22\)](#). WinTest, available at [WinTest Test and Demonstration Software](#), easily allows setting up the scrolling marquee and adjusting the parameters so you can find a setting you like in a minimum amount of time.

Wrap ON (\023, Control+W)

Turns wrap feature on. When wrap is on, a printable character received when the cursor is at the right-most column will cause the cursor to move down one row to the left-most column. If the cursor is already at the right-most column of the bottom row, it will wrap to the top row if Scroll is off, or the display will scroll up one row if Scroll is on.

Wrap OFF (\024, Control+X)

Turns wrap feature off. When wrap is off, a printable character received when the cursor is at the right-most column will cause the cursor to disappear (as it will be off the right edge of the screen) and any subsequent characters will be ignored until some other command moves the cursor back onto the display. This function is independent of Scroll.



Set Custom Character Bitmap (\025, Control+Y)

The custom characters are mapped at \128 through \135 corresponding to character 0 to character 7.

Send "Control+Y" followed by the following bytes:

- character***
- data0***
- data1***
- data2***
- data3***
- data4***
- data5***
- data6***
- data7***

character determines which of the eight custom characters is modified. 0-7 is valid. The custom characters are displayed by sending \128 to \135:

| <i>character</i> | CUSTOM CHARACTER MODIFIED |
|-------------------------|----------------------------------|
| \128 | 0 |
| \129 | 1 |
| \130 | 2 |
| \131 | 3 |
| \132 | 4 |
| \133 | 5 |
| \134 | 6 |
| \135 | 7 |

data0-data7 are the bitmap information for this character. Any value is valid between 0 and 63. The MSB is at the left of the character cell of the row and the LSB is at the right of the character cell. ***data0*** is at the top of the cell, ***data7*** is at the bottom of the cell.

NOTE
 The large digits use all of the custom characters, so if you modify the custom characters when large digits are displayed, the display will probably become corrupted. The bar graphs also use some of the custom characters.



Examples:

```
\012\001\128\129\130\131\017\000\001\132\133\134\135
\025\000\000\000\001\003\000\031\031\031
\025\001\028\054\032\001\003\051\051\051
\025\002\014\027\049\032\032\047\032\047
\025\003\000\000\032\048\000\062\000\062
\025\004\031\031\031\000\003\001\000\000
\025\005\051\051\051\003\001\032\054\028
\025\006\047\032\047\032\032\049\027\014
\025\007\062\000\062\000\048\032\000\000
```

Reboot (\026, Control+Z)

CFA632 firmware is very stable and robust, and it is unlikely that you will ever need a "reboot" command. If the firmware did crash, the command processor would most likely be inoperable and unable to detect the reboot command. However, you may have certain situations where it is nice to have a command that will return the display to a known state. For instance, if the baud rate on the host is set to an incorrect speed, the data is interpreted as meaningless garbage which the display firmware tries to interpret. Some data may set the contrast to an unusable value; some data may program the LCD controller to an indeterminate state. Or perhaps you always want the display to wake up in a given state when your program starts, without going through all the commands that affect the way the display interprets commands (such as the state of Scroll or Wrap, for instance).

Send one "Control+Z" followed by another "Control+Z" to reboot the display. If you are not sure of the display state, it may be necessary to send up to 9 characters to satisfy the parameters of some previous command. For example, if the Set Custom Character Bitmap command (See [Set Custom Character Bitmap \(\025, Control+Y\) \(Pg. 25\)](#)) has just been received by the display when an application crashes, the display will interpret the next 9 bytes as the parameters to the command, then wait for more commands. If you are not sure what the status of the display is, send 9 blanks (\032) followed by two "Control+Z"s (\026).

Escape Sequence Prefix (\027, Escape)

Four escape sequences are supported. These correspond to the escape sequences that are sent for the four arrows keys in HyperTerminal with an ANSI terminal selected (and also our WinTest). These sequences move the cursor only and do not wrap.

| ESCAPE SEQUENCE | ARROW KEY |
|--------------------------------------|-------------|
| ESC [A (equivalent to \027\091\065) | UP arrow |
| ESC [B (equivalent to \027\091\066) | DOWN arrow |
| ESC [C (equivalent to \027\091\067) | RIGHT arrow |
| ESC [D (equivalent to \027\091\068) | LEFT arrow |



Reserved (\028, Control+Backslash)

Reserved (\029, Control+Quote)

Send Data Directly to the LCD Controller (\030, Control+Equal)

Send "Control+Equal" followed by the following bytes:

location
data

location is the destination register on the LCD controller:

| <i>location</i> | REGISTER |
|-----------------|--------------------------------|
| \000 | Control Register, (RS=0, RE=0) |
| \001 | Data Memory, (RS=1, RE=x) |
| \002 | Control Register, (RS=0, RE=1) |

data is the data to write to the controller.

NOTE

This command executes a low level write directly to the controller. Use this command at your own risk. "Control+Z" followed by another "Control+Z" will reboot the display and recover from most mistakes.

Example:

```
\030\002\031\030\002\130
```

Show Information Screen (\031, Control+Minus)

This command will show the baud rate, version, and model number.



CHARACTER GENERATOR ROM (CGROM)

| upper 4 bits lower 4 bits | 0 _d 0000. | 16 _d 0001. | 32 _d 0010. | 48 _d 0011. | 64 _d 0100. | 80 _d 0101. | 96 _d 0110. | 112 _d 0111. | 128 _d 1000. | 144 _d 1001. | 160 _d 1010. | 176 _d 1011. | 192 _d 1100. | 208 _d 1101. | 224 _d 1110. | 240 _d 1111. |
|------------------------------|-------------------------|--------------------------|--------------------------|--------------------------|--------------------------|--------------------------|--------------------------|---------------------------|---------------------------|---------------------------|---------------------------|---------------------------|---------------------------|---------------------------|---------------------------|---------------------------|
| 0 _d 0000. | CGRAM [0] | | | | | | | | | | | | | | | |
| 1 _d 0001. | CGRAM [1] | | | | | | | | | | | | | | | |
| 2 _d 0010. | CGRAM [2] | | | | | | | | | | | | | | | |
| 3 _d 0011. | CGRAM [3] | | | | | | | | | | | | | | | |
| 4 _d 0100. | CGRAM [4] | | | | | | | | | | | | | | | |
| 5 _d 0101. | CGRAM [5] | | | | | | | | | | | | | | | |
| 6 _d 0110. | CGRAM [6] | | | | | | | | | | | | | | | |
| 7 _d 0111. | CGRAM [7] | | | | | | | | | | | | | | | |
| 8 _d 1000. | CGRAM [0] | | | | | | | | | | | | | | | |
| 9 _d 1001. | CGRAM [1] | | | | | | | | | | | | | | | |
| 10 _d 1010. | CGRAM [2] | | | | | | | | | | | | | | | |
| 11 _d 1011. | CGRAM [3] | | | | | | | | | | | | | | | |
| 12 _d 1100. | CGRAM [4] | | | | | | | | | | | | | | | |
| 13 _d 1101. | CGRAM [5] | | | | | | | | | | | | | | | |
| 14 _d 1110. | CGRAM [6] | | | | | | | | | | | | | | | |
| 15 _d 1111. | CGRAM [7] | | | | | | | | | | | | | | | |

Figure 6. CFA632 Character Generator ROM (CGROM)



HOW TO USE CGROM

The CGROM defines which characters are shown by the display for a given code received through the interface. The CFA632 firmware v2.0 has an enhanced CGROM that includes many useful special characters (including numeric superscripts, icons, mathematical symbols, some fractions, a great variety of arrows, many currency symbols. . .).

Most of the characters can be accessed by sending the appropriate ASCII code to the display. For instance, the letter "A" can be shown by sending an "A" (which is the same as a "decimal 65", a "hex 0x41", or a "\065").

Some characters do not have an obvious match. For instance, the code to display a superscript "9" is "decimal 137", "hex 0x89", or "\137". The relationship between the codes and the characters are shown on in the [CFA632 Character Generator ROM \(CGROM\) \(Pg. 28\)](#)

To find the code for a given character, add the two numbers that are shown in bold for its row and column. For example, the superscript "9" is in the column labeled "128d" and in the row labeled "9d". So you would add 128 + 9 to get 137. When you send a byte with the value of 137 to the display, then a superscript "9" will be shown at the current cursor position.

In the CFA632 v1.0, the CGROM table had several columns that did not have any characters assigned to the codes. The commands to control the display were mapped to some of those unused codes. These codes are shown in red in the table. Specifically, the first 32 codes (0 to 31) are reserved for the display's special functions (cursor positioning, contrast control, bar graphs. . .), and the codes from 128 to 135 are used to access the custom characters.

To access the characters shown in red, it is necessary to send some data directly to the LCD controller. [Send Data Directly to the LCD Controller \(\030, Control+Equal\) \(Pg. 27\)](#) allows any character in the CGROM to be displayed.

For example, if you want to display an arrow that points to the upper left, look at the table and note that it is in column "16d", and in row "6d", so its code is 22 (16 + 6 = 22). Use the following sequence to display the arrow that points to the upper left:

```
\030\001\022
```

This sequence of three bytes must be used to display any of the characters shown in red in the table. It can also be used to access any character in the table.

MODULE RELIABILITY AND LONGEVITY

MODULE RELIABILITY

| ITEM | SPECIFICATION |
|---------------------------|-----------------------------------|
| LCD Module (no Backlight) | 50,000 to 100,000 hours (typical) |

MODULE LONGEVITY (EOL / REPLACEMENT POLICY)

CrystalFontz is committed to making all of our LCD modules available for as long as possible. For each module we introduce, we intend to offer it indefinitely. We do not preplan a module's obsolescence. The majority of modules we have introduced are still available.



We recognize that discontinuing a module may cause problems for some customers. However, rapidly changing technologies, component availability, or low customer order levels may force us to discontinue (“End of Life”, EOL) a module. For example, we must occasionally discontinue a module when a supplier discontinues a component or a manufacturing process becomes obsolete. When we discontinue a module, we will do our best to find an acceptable replacement module with the same fit, form, and function.

In most situations, you will not notice a difference when comparing a “fit, form, and function” replacement module to the discontinued module it replaces. However, sometimes a change in component or process for the replacement module results in a slight variation, perhaps an improvement, over the previous design.

Although the replacement module is still within the stated Data Sheet specifications and tolerances of the discontinued module, changes may require modification to your circuit and/or firmware. Possible changes include:

- *Backlight LEDs.* Brightness may be affected (perhaps the new LEDs have better efficiency) or the current they draw may change (new LEDs may have a different VF).
- *Controller.* A new controller may require minor changes in your code.
- *Component tolerances.* Module components have manufacturing tolerances. In extreme cases, the tolerance stack can change the visual or operating characteristics.

Please understand that we avoid changing a module whenever possible. We only discontinue a module if we have no other option. We will post Part Change Notices (PCN) on the product's web page as soon as possible. If interested, you can subscribe to future part change notifications.

CARE AND HANDLING PRECAUTIONS

For optimum operation of the display and to prolong its life, please follow the precautions described below.

ELECTROSTATIC DISCHARGE (ESD)

The circuitry is industry standard CMOS logic and susceptible to ESD damage. Please use industry standard antistatic precautions as you would for any other static sensitive devices such as expansion cards, motherboards, or integrated circuits. Ground your body, work surfaces, and equipment.

DESIGN AND MOUNTING

- The exposed surface of the LCD “glass” is actually a polarizer laminated on top of the glass. To protect the soft plastic polarizer from damage, the module ships with a protective film over the polarizer. Please peel off the protective film slowly. Peeling off the protective film abruptly may generate static electricity.
- The polarizer is made out of soft plastic and is easily scratched or damaged. When handling the LCD module, avoid touching the polarizer. Finger oils are difficult to remove.
- *Display without CrystalFontz overlay:* To protect the soft plastic polarizer from damage, place a transparent plate (for example, acrylic, polycarbonate, or glass) in front of the LCD module, leaving a small gap between the plate and the display surface. We use GE HP-92 Lexan, which is readily available and works well.
- Do not disassemble or modify the LCD module.
- Do not modify the six tabs of the metal bezel or make connections to them.
- Solder only to the I/O terminals. Use care when removing solder. It is possible to damage the PCB.
- Do not reverse polarity to the power supply connections. Reversing polarity will immediately ruin the LCD module.



AVOID SHOCK, IMPACT, TORQUE, OR TENSION

- Do not expose the LCD module to strong mechanical shock, impact, torque, or tension.
- Do not drop, toss, bend, or twist the LCD module.
- Do not place weight or pressure on the LCD module.

IF LCD PANEL BREAKS

- If the LCD panel breaks, be careful to not get the liquid crystal fluid in your mouth or eyes.
- If the liquid crystal fluid touches your skin, clothes, or work surface, wash it off immediately using soap and plenty of water.

CLEANING

- The polarizer (laminated to the glass) is soft plastic. The soft plastic is easily scratched or damaged. Be very careful when you clean the polarizer.
- Do not clean the polarizer with liquids. Do not wipe the polarizer with any type of cloth or swab (for example, Q-tips).
- Use the removable protective film to remove smudges (for example, fingerprints) and any foreign matter. If you no longer have the protective film, use standard transparent office tape (for example, Scotch® brand “Crystal Clear Tape”). If the polarizer is dusty, you may carefully blow it off with clean, dry, oil-free compressed air.
- *Display without Crystalfontz overlay:* The exposed surface of the LCD “glass” is actually the front polarizer laminated to the glass. The polarizer is made out of a fairly soft plastic and is easily scratched or damaged. The polarizer will eventually become hazy if you do not take great care when cleaning it. Long contact with moisture (from condensation or cleaning) may permanently spot or stain the polarizer.

OPERATION

- Your circuit should be designed to protect the display from ESD and power supply transients.
- Observe the operating temperature limitations: -20°C minimum to +70°C maximum with minimal fluctuation. Operation outside of these limits may shorten life and/or harm display.
 - At lower temperatures of this range, response time is delayed.
 - At higher temperatures of this range, display becomes dark. (You may need to adjust the contrast.)
- Operate away from dust, moisture, and direct sunlight.

STORAGE AND RECYCLING

- Store in an ESD-approved container away from dust, moisture, and direct sunlight.
- Observe the storage temperature limitations: -30°C minimum to +80°C maximum with minimal fluctuation. Rapid temperature changes can cause moisture to form, resulting in permanent damage.
- Do not allow weight to be placed on the displays while they are in storage.
- Please recycle your outdated Crystalfontz modules at an approved facility.



APPENDIX A: QUALITY ASSURANCE STANDARDS

INSPECTION CONDITIONS

- Environment
 - Temperature: $25\pm 5^{\circ}\text{C}$
 - Humidity: 30~85% RH
- For visual inspection of active display area
 - Source lighting: two 20 Watt or one 40 Watt fluorescent light
 - Display adjusted for best contrast
 - Viewing distance: 30 ± 5 cm (about 12 inches)
 - Viewable angle: inspect at 45° angle of vertical line right and left, top and bottom

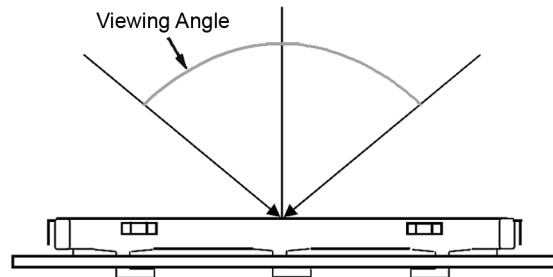

COLOR DEFINITIONS

We try to describe the appearance of our modules as accurately as possible. For the photos, we adjust for optimal appearance. Actual display appearance may vary due to (1) different operating conditions, (2) small variations of component tolerances, (3) inaccuracies of our camera, (4) color interpretation of the photos on your monitor, and/or (5) personal differences in the perception of color.

DEFINITION OF ACTIVE AREA AND VIEWABLE AREA

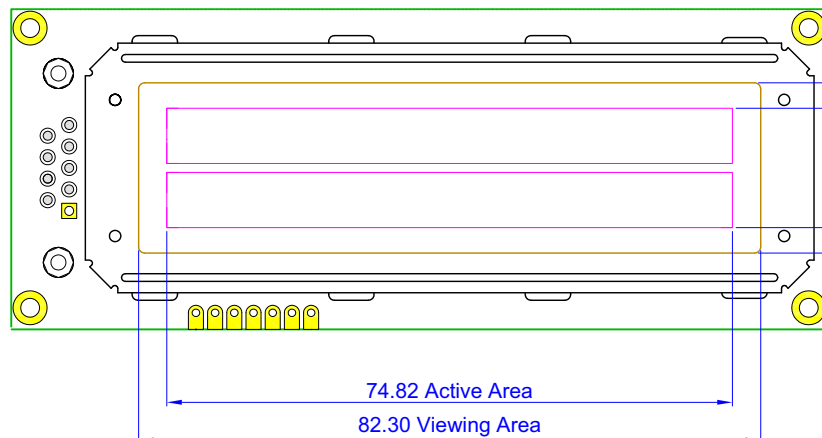



ACCEPTANCE SAMPLING

| DEFECT TYPE | AQL* |
|--|--------|
| Major | ≤0.65% |
| Minor | ≤1.00% |
| *Acceptable Quality Level: maximum allowable error rate or variation from standard | |

DEFECTS CLASSIFICATION

Defects are defined as:

- Major Defect: results in failure or substantially reduces usability of unit for its intended purpose
- Minor Defect: deviates from standards but is not likely to reduce usability for its intended purpose

ACCEPTANCE STANDARDS

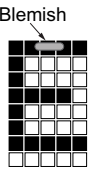
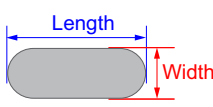
| # | DEFECT TYPE | CRITERIA | | MAJOR / MINOR | |
|---|---|--|---------------------------------------|-----------------------|-------|
| 1 | Electrical defects | 1. No display, display malfunctions, or shorted segments. 2. Current consumption exceeds specifications. | | Major | |
| 2 | Viewing area defect | Viewing area does not meet specifications. (See Inspection Conditions (Pg. 32)). | | Major | |
| 3 | Contrast adjustment defect | Contrast adjustment fails or malfunctions. | | Major | |
| 4 | Blemishes or foreign matter on display segments |  | <i>Defect Size (mm)</i> | <i>Acceptable Qty</i> | Minor |
| | | | ≤0.3 | 3 | |
| | | | ≤2 defects within 10 mm of each other | | |
| 5 | Other blemishes or foreign matter outside of display segments | Defect size = (A + B)/2  | <i>Defect Size (mm)</i> | <i>Acceptable Qty</i> | Minor |
| | | | ≤0.15 | Ignore | |
| | | | 0.15 to 0.20 | 3 | |
| | | | 0.20 to 0.25 | 2 | |
| | | | 0.25 to 0.30 | 1 | |

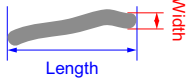
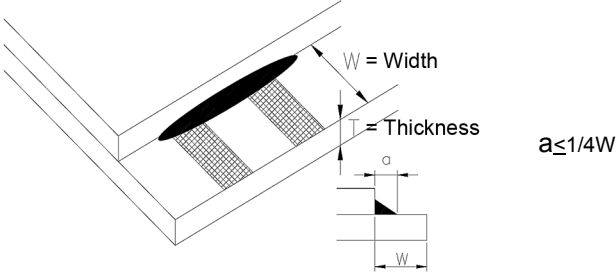
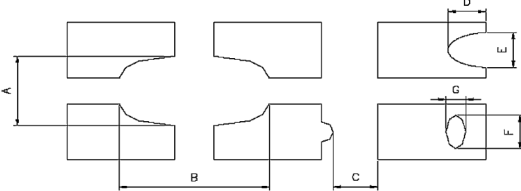

| # | DEFECT TYPE | CRITERIA | | | MAJOR / MINOR |
|---|--|--|---|-----------------------|---------------|
| 6 | Dark lines or scratches in display area  | <i>Defect Width (mm)</i> | <i>Defect Length (mm)</i> | <i>Acceptable Qty</i> | Minor |
| | | ≤0.03 | ≤3.0 | 3 | |
| | | 0.03 to 0.05 | ≤2.0 | 2 | |
| | | 0.05 to 0.08 | ≤2.0 | 1 | |
| | | 0.08 to 0.10 | ≤3.0 | 0 | |
| | | ≥0.10 | >3.0 | 0 | |
| 7 | Bubbles between polarizer film and glass | <i>Defect Size (mm)</i> | <i>Acceptable Qty</i> | Minor | |
| | | ≤0.20 | Ignore | | |
| | | 0.20 to 0.40 | 3 | | |
| | | 0.40 to 0.60 | 2 | | |
| | | ≥0.60 | 0 | | |
| 8 | Glass rest defect |  | | | Minor |
| 9 | Display pattern defect |  | | | Minor |
| | | <i>Dot Size (mm)</i> | <i>Acceptable Qty</i> | | |
| | | $((A+B)/2) \leq 0.2$ | ≤ 3 total defects ≤ 2 pinholes per digit | | |
| | | $C > 0$ | | | |
| | | $((D+E)/2) \leq 0.25$ | | | |
| | | $((F+G)/2) \leq 0.25$ | | | |



| # | DEFECT TYPE | CRITERIA | MAJOR / MINOR | | | | | | | | | | | | |
|-------------|---|--|---------------|---|---|----------------|----------------|-------------|------------|-------------|---------------|-------------|------------|----------|---|
| 10 | Chip in corner | | Minor | | | | | | | | | | | | |
| | | <table border="1"> <thead> <tr> <th>a</th> <th>b</th> <th>c</th> <th>Acceptable Qty</th> </tr> </thead> <tbody> <tr> <td><4 mm</td> <td>$\leq W$</td> <td>$c \leq T$</td> <td>3</td> </tr> </tbody> </table> | | a | b | c | Acceptable Qty | <4 mm | $\leq W$ | $c \leq T$ | 3 | | | | |
| | | a | | b | c | Acceptable Qty | | | | | | | | | |
| <4 mm | $\leq W$ | $c \leq T$ | 3 | | | | | | | | | | | | |
| | | | | | | | | | | | | | | | |
| 11 | Chip on "non-contact" edge of LCD | | Minor | | | | | | | | | | | | |
| | | <table border="1"> <thead> <tr> <th>a</th> <th>b</th> <th>c</th> </tr> </thead> <tbody> <tr> <td>≤ 3 mm</td> <td>≤ 1 mm</td> <td>$\leq T$</td> </tr> <tr> <td>≤ 4 mm</td> <td>≤ 1.5 mm</td> <td>$\leq T$</td> </tr> </tbody> </table> | | a | b | c | ≤ 3 mm | ≤ 1 mm | $\leq T$ | ≤ 4 mm | ≤ 1.5 mm | $\leq T$ | | | |
| | | a | | b | c | | | | | | | | | | |
| ≤ 3 mm | ≤ 1 mm | $\leq T$ | | | | | | | | | | | | | |
| ≤ 4 mm | ≤ 1.5 mm | $\leq T$ | | | | | | | | | | | | | |
| | | | | | | | | | | | | | | | |
| 12 | Chip on "contact" edge of LCD, on the active side | | Minor | | | | | | | | | | | | |
| | | <table border="1"> <thead> <tr> <th>a</th> <th>b</th> <th>c</th> <th>Acceptable Qty</th> </tr> </thead> <tbody> <tr> <td>≤ 2 mm</td> <td>$\leq W/4$</td> <td>$\leq T$</td> <td>Ignore</td> </tr> <tr> <td>≤ 3 mm</td> <td>$\leq W/4$</td> <td>$\leq T$</td> <td>3</td> </tr> </tbody> </table> | | a | b | c | Acceptable Qty | ≤ 2 mm | $\leq W/4$ | $\leq T$ | Ignore | ≤ 3 mm | $\leq W/4$ | $\leq T$ | 3 |
| | | a | | b | c | Acceptable Qty | | | | | | | | | |
| ≤ 2 mm | $\leq W/4$ | $\leq T$ | Ignore | | | | | | | | | | | | |
| ≤ 3 mm | $\leq W/4$ | $\leq T$ | 3 | | | | | | | | | | | | |
| | | | | | | | | | | | | | | | |



| # | DEFECT TYPE | CRITERIA | MAJOR / MINOR | | | | | | | | | | | | |
|--|---|---|----------------|----------------|-------|----------------|----------------|-------|---------|--------|--------|-------|---------|----|---|
| 13 | Chip on "contact" edge of LCD, on the inactive side | | Minor | | | | | | | | | | | | |
| | | <table border="1"> <thead> <tr> <th>a</th> <th>b</th> <th>c</th> <th>Acceptable Qty</th> </tr> </thead> <tbody> <tr> <td>≤3 mm</td> <td>≤1 mm</td> <td>≤T</td> <td>Ignore</td> </tr> <tr> <td>≤4 mm</td> <td>≤1.5 mm</td> <td>≤T</td> <td>3</td> </tr> </tbody> </table> | | a | b | c | Acceptable Qty | ≤3 mm | ≤1 mm | ≤T | Ignore | ≤4 mm | ≤1.5 mm | ≤T | 3 |
| | | a | | b | c | Acceptable Qty | | | | | | | | | |
| | | ≤3 mm | | ≤1 mm | ≤T | Ignore | | | | | | | | | |
| ≤4 mm | ≤1.5 mm | ≤T | 3 | | | | | | | | | | | | |
| <table border="1"> <thead> <tr> <th>a</th> <th>b</th> <th>c</th> <th>Acceptable Qty</th> </tr> </thead> <tbody> <tr> <td><3 mm</td> <td>≤1.5 mm</td> <td>≤1/2 T</td> <td>3</td> </tr> </tbody> </table> | a | b | c | Acceptable Qty | <3 mm | ≤1.5 mm | ≤1/2 T | 3 | | | | | | | |
| a | b | c | Acceptable Qty | | | | | | | | | | | | |
| <3 mm | ≤1.5 mm | ≤1/2 T | 3 | | | | | | | | | | | | |
| Unacceptable if c > 50% of glass thickness or if the seal area is damaged. | Major | | | | | | | | | | | | | | |
| 14 | Chip in seal area | <p> a = length b = width c = thickness </p> | Minor | | | | | | | | | | | | |
| | | <table border="1"> <thead> <tr> <th>a</th> <th>b</th> <th>c</th> <th>Acceptable Qty</th> </tr> </thead> <tbody> <tr> <td><3 mm</td> <td>≤1.5 mm</td> <td>≤1/2 T</td> <td>3</td> </tr> </tbody> </table> | | a | b | c | Acceptable Qty | <3 mm | ≤1.5 mm | ≤1/2 T | 3 | | | | |
| | | a | | b | c | Acceptable Qty | | | | | | | | | |
| <3 mm | ≤1.5 mm | ≤1/2 T | 3 | | | | | | | | | | | | |
| Unacceptable if c > 50% of glass thickness or if the seal area is damaged. | Major | | | | | | | | | | | | | | |
| 15 | Backlight defects | <ol style="list-style-type: none"> 1. Light fails or flickers.* 2. Color and luminance do not correspond to specifications.* 3. Exceeds standards for display's blemishes or foreign matter (see test 5, Pg. 33), and dark lines or scratches (see test 6, Pg. 34). <p><i>*Minor if display functions correctly. Major if the display fails.</i></p> | Minor | | | | | | | | | | | | |
| 16 | COB defects | <ol style="list-style-type: none"> 1. Pinholes >0.2 mm. 2. Seal surface has pinholes through to the IC. 3. More than 3 locations of sealant beyond 2 mm of the sealed areas. | Minor | | | | | | | | | | | | |
| 17 | PCB defects | <ol style="list-style-type: none"> 1. Oxidation or contamination on connectors.* 2. Wrong parts, missing parts, or parts not in specification.* 3. Jumpers set incorrectly. 4. Solder (if any) on bezel, LED pad, zebra pad, or screw hole pad is not smooth. <p><i>*Minor if display functions correctly. Major if the display fails.</i></p> | Minor | | | | | | | | | | | | |



| # | DEFECT TYPE | CRITERIA | MAJOR / MINOR |
|----|-------------------|---|---------------|
| 18 | Soldering defects | 1. Unmelted solder paste. 2. Cold solder joints, missing solder connections, or oxidation.* 3. Solder bridges causing short circuits.* 4. Residue or solder balls. 5. Solder flux is black or brown. <i>*Minor if display functions correctly. Major if the display fails.</i> | Minor |