

Crystalfontz America, Inc.

SPECIFICATION

CUSTOMER : _____

MODULE NO.: **CFAG12864F-YYH-TY**

| SALES BY | APPROVED BY | CHECKED BY | PREPARED BY |
|---------------------|--------------------|-------------------|--------------------|
| | | | |
| ISSUED DATE: | | | |

Crystalfontz America, Inc.

12412 East Saltese Avenue
Spokane Valley, WA 99216-0357

Phone: (888) 206-9720

Fax: (509) 892-1203

Email: techinfo@crystalfontz.com

URL: www.crystalfontz.com

Contents

- 1.Module Classification Information
- 2.Precautions in use of LCD Modules
- 3.General Specification
- 4.Absolute Maximum Ratings
- 5.Electrical Characteristics
- 6.Optical Characteristics
- 7.Interface Pin Function
- 8.Contour Drawing & Block Diagram
- 9.Display control instruction
- 10.Timing Characteristics
- 11.Reliability
- 12.Backlight Information
13. Material List of Components for RoHS

1. Module Classification Information

CFA G 12864 F YYH TY

① ② ③ ④ ⑤ ⑥ ⑦ ⑧

| | | | | | | | | | | | | | | |
|---|---|--|---|----------------------------------|--------------------------|----------------------------|--------------------------|--------------------------|-------------------------------------|---------------------------|---------------------------|----------------------------|----------------------------|---------------------------|
| ① | Brand: CRYSTALFONTZ AMERICA, INC | | | | | | | | | | | | | |
| ② | Display Type: H→Character Type, G→Graphic Type | | | | | | | | | | | | | |
| ③ | Displays Logical Dimensions: 128 pixels by 64 pixels | | | | | | | | | | | | | |
| ④ | Model PCB Variant: F | | | | | | | | | | | | | |
| ⑤ | Backlight Type: | <table border="0"> <tr> <td>N→Without backlight</td> <td>T→LED, White</td> </tr> <tr> <td>B→EL, Blue green</td> <td>A→LED, Amber</td> </tr> <tr> <td>D→EL, Green</td> <td>R→LED, Red</td> </tr> <tr> <td>W→EL, White</td> <td>O→LED, Orange</td> </tr> <tr> <td>F→CCFL, White</td> <td>G→LED, Green</td> </tr> <tr> <td>Y→LED, Yellow Green</td> <td>S→LED, High output white</td> </tr> </table> | N→Without backlight | T→LED, White | B→EL, Blue green | A→LED, Amber | D→EL, Green | R→LED, Red | W→EL, White | O→LED, Orange | F→CCFL, White | G→LED, Green | Y→LED, Yellow Green | S→LED, High output white |
| N→Without backlight | T→LED, White | | | | | | | | | | | | | |
| B→EL, Blue green | A→LED, Amber | | | | | | | | | | | | | |
| D→EL, Green | R→LED, Red | | | | | | | | | | | | | |
| W→EL, White | O→LED, Orange | | | | | | | | | | | | | |
| F→CCFL, White | G→LED, Green | | | | | | | | | | | | | |
| Y→LED, Yellow Green | S→LED, High output white | | | | | | | | | | | | | |
| ⑥ | LCD Mode: | <table border="0"> <tr> <td>B→TN Positive, Gray</td> <td>T→FSTN Negative</td> </tr> <tr> <td>N→TN Negative,</td> <td></td> </tr> <tr> <td>G→STN Positive, Gray</td> <td></td> </tr> <tr> <td>Y→STN Positive, Yellow Green</td> <td></td> </tr> <tr> <td>M→STN Negative, Blue</td> <td></td> </tr> <tr> <td>F→FSTN Positive</td> <td></td> </tr> </table> | B→TN Positive, Gray | T→FSTN Negative | N→TN Negative, | | G→STN Positive, Gray | | Y→STN Positive, Yellow Green | | M→STN Negative, Blue | | F→FSTN Positive | |
| B→TN Positive, Gray | T→FSTN Negative | | | | | | | | | | | | | |
| N→TN Negative, | | | | | | | | | | | | | | |
| G→STN Positive, Gray | | | | | | | | | | | | | | |
| Y→STN Positive, Yellow Green | | | | | | | | | | | | | | |
| M→STN Negative, Blue | | | | | | | | | | | | | | |
| F→FSTN Positive | | | | | | | | | | | | | | |
| ⑦ | LCD Polarizer Type/ Temperature range/ View direction | <table border="0"> <tr> <td>A→Reflective, N.T, 6:00</td> <td>H→Transflective, W.T,6:00</td> </tr> <tr> <td>D→Reflective, N.T, 12:00</td> <td>K→Transflective, W.T,12:00</td> </tr> <tr> <td>G→Reflective, W. T, 6:00</td> <td>C→Transmissive, N.T,6:00</td> </tr> <tr> <td>J→Reflective, W. T, 12:00</td> <td>F→Transmissive, N.T,12:00</td> </tr> <tr> <td>B→Transflective, N.T,6:00</td> <td>I→Transmissive, W. T, 6:00</td> </tr> <tr> <td>E→Transflective, N.T.12:00</td> <td>L→Transmissive, W.T,12:00</td> </tr> </table> | A→Reflective, N.T, 6:00 | H→Transflective, W.T,6:00 | D→Reflective, N.T, 12:00 | K→Transflective, W.T,12:00 | G→Reflective, W. T, 6:00 | C→Transmissive, N.T,6:00 | J→Reflective, W. T, 12:00 | F→Transmissive, N.T,12:00 | B→Transflective, N.T,6:00 | I→Transmissive, W. T, 6:00 | E→Transflective, N.T.12:00 | L→Transmissive, W.T,12:00 |
| A→Reflective, N.T, 6:00 | H→Transflective, W.T,6:00 | | | | | | | | | | | | | |
| D→Reflective, N.T, 12:00 | K→Transflective, W.T,12:00 | | | | | | | | | | | | | |
| G→Reflective, W. T, 6:00 | C→Transmissive, N.T,6:00 | | | | | | | | | | | | | |
| J→Reflective, W. T, 12:00 | F→Transmissive, N.T,12:00 | | | | | | | | | | | | | |
| B→Transflective, N.T,6:00 | I→Transmissive, W. T, 6:00 | | | | | | | | | | | | | |
| E→Transflective, N.T.12:00 | L→Transmissive, W.T,12:00 | | | | | | | | | | | | | |
| ⑧ | Special Code | <table border="0"> <tr> <td>T→Negative voltage generator on board and temperature compensation</td> </tr> <tr> <td>Y→Sanyo IC</td> </tr> </table> | T→Negative voltage generator on board and temperature compensation | Y→Sanyo IC | | | | | | | | | | |
| T→Negative voltage generator on board and temperature compensation | | | | | | | | | | | | | | |
| Y→Sanyo IC | | | | | | | | | | | | | | |

2. Precautions in Use of LCD Module

- (1) Avoid applying excessive shocks to the module or making any alterations or modifications to it.
- (2) Don't make extra holes on the printed circuit board, modify its shape or change the components of LCD Module.
- (3) Don't disassemble the LCM.
- (4) Don't operate it above the absolute maximum rating.
- (5) Don't drop, bend or twist LCM.
- (6) Soldering: only to the I/O terminals.
- (7) Storage: please storage in anti-static electricity container and clean environment.

3. General Specification

| Item | Dimension | Unit |
|----------------------|--|-------------|
| Number of Characters | 128 x 64 dots | — |
| Module dimension | 87.0 x 70.0 x 13.6(MAX) | mm |
| View area | 72.0 x 40.0 | mm |
| Active area | 66.52 x 33.24 | mm |
| Dot size | 0.48 x 0.48 | mm |
| Dot pitch | 0.52 x 0.52 | mm |
| LCD type | STN, Positive, Transflective, Yellow Green | |
| Duty | 1/64 | |
| View direction | 6 o'clock | |
| Backlight Type | LED Yellow Green | |

4. Absolute Maximum Ratings

| Item | Symbol | Min | Typ | Max | Unit |
|--------------------------|-----------------|----------|-----|----------|------|
| Operating Temperature | T_{OP} | -20 | — | +70 | °C |
| Storage Temperature | T_{ST} | -30 | — | +80 | °C |
| Input Voltage | V_I | V_{SS} | — | V_{DD} | V |
| Supply Voltage For Logic | $V_{DD}-V_{SS}$ | -0.3 | — | +7 | V |
| Supply Voltage For LCD | $V_{DD}-V_0$ | 0 | — | 15 | V |
| Negative Voltage Output | V_{EE} | — | 10 | — | V |

5. Electrical Characteristics

| Item | Symbol | Condition | Min | Typ | Max | Unit |
|--------------------------|-----------------|---------------------------|--------------|------|----------|------|
| Supply Voltage For Logic | $V_{DD}-V_{SS}$ | — | 4.75 | 5.0 | 5.25 | V |
| Supply Voltage For LCD | $V_{DD}-V_0$ | $T_a=-20^{\circ}\text{C}$ | — | — | 10.6 | V |
| | | $T_a=25^{\circ}\text{C}$ | — | 9.1 | — | V |
| | | $T_a=+70^{\circ}\text{C}$ | 7.6 | — | — | V |
| Input High Volt. | V_{IH} | — | $V_{DD}-2.2$ | — | V_{DD} | V |
| Input Low Volt. | V_{IL} | — | 0 | — | 0.8 | V |
| Output High Volt. | V_{OH} | — | $V_{DD}-0.3$ | — | V_{DD} | V |
| Output Low Volt. | V_{OL} | — | 0 | — | 0.3 | V |
| Supply Current | I_{DD} | $V_{DD}=5.0\text{V}$ | 12.0 | 16.0 | 18.0 | mA |

6. Optical Characteristics

| ITEM | SYMBOL | CONDITION | MIN. | TYP. | MAX. | UNIT |
|----------------|--------------|-------------|------|------|------|------|
| View Angle | (V) θ | $CR \geq 2$ | 20 | | 40 | deg |
| | (H) ϕ | $CR \geq 2$ | -30 | | 30 | deg |
| Contrast Ratio | CR | — | | 3 | | — |
| Response Time | T rise | — | | 200 | 300 | ms |
| | T fall | — | | 200 | 300 | ms |

6.1 Definitions

View Angles

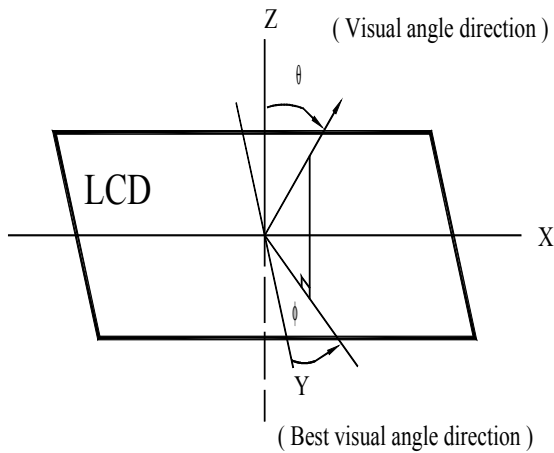

Contrast Ratio

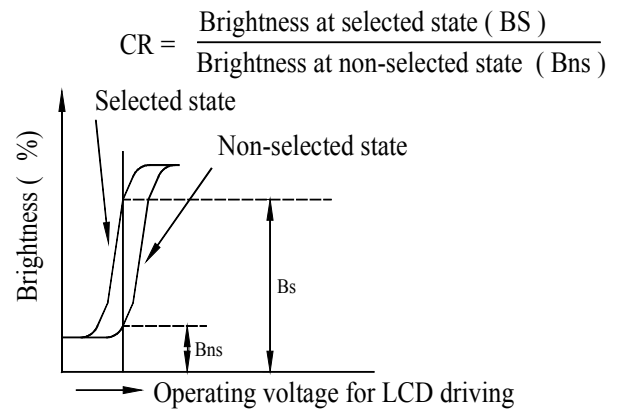

Response Time

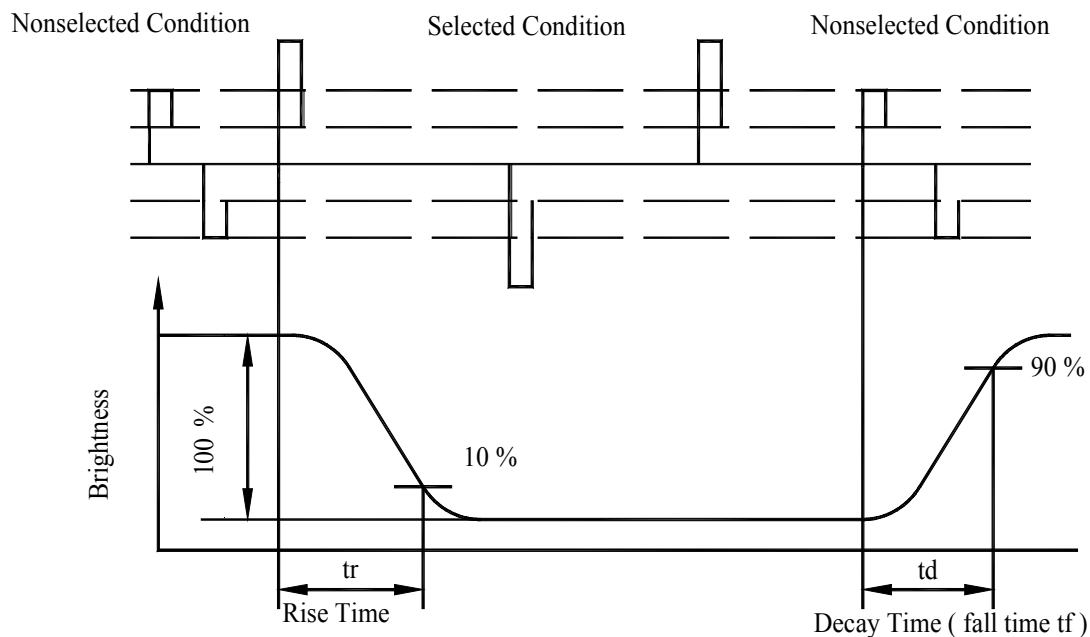

7. Interface Pin Function

| Pin No. | Symbol | Level | Description |
|---------|--------|-------|---|
| 1 | Vss | — | GND |
| 2 | Vdd | — | Power supply (+5 V) |
| 3 | Vo | — | Power supply for LCD driver |
| 4 | C/D | H / L | WR=L , C/D=H : Command Write C/D=L: Data write RD=L , C/D=H : Status Read C/D=L: Data read |
| 5 | RD | L | Data read. Read data from T6963C when RD = L |
| 6 | WR | L | Data write. Write data into T6963C when WR = L |
| 7 | DB0 | H / L | Data bus line |
| 8 | DB1 | H / L | Data bus line |
| 9 | DB2 | H / L | Data bus line |
| 10 | DB3 | H / L | Data bus line |
| 11 | DB4 | H / L | Data bus line |
| 12 | DB5 | H / L | Data bus line |
| 13 | DB6 | H / L | Data bus line |
| 14 | DB7 | H / L | Data bus line |
| 15 | CE | L | L : Chip enable |
| 16 | /RST | H / L | H : Normal ; L : Initialize T6963C |
| 17 | Vee | -5v | Negative voltage |
| 18 | MD2 | H / L | Column select ; H:32 column ; L:40 column |
| 19 | FS1 | H / L | Pins for selection of font; H : 6 * 8 , L : 8 * 8 |
| 20 | /HLT | H / L | |

8. Contour Drawing & Block Diagram

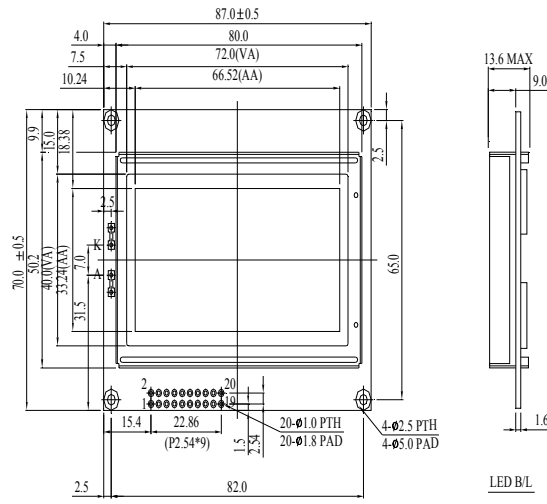

| PIN NO. | SYMBOL |
|---------|--------|
| 1 | Vss |
| 2 | Vdd |
| 3 | Vo |
| 4 | C/D |
| 5 | RD |
| 6 | WR |
| 7 | DB0 |
| 8 | DB1 |
| 9 | DB2 |
| 10 | DB3 |
| 11 | DB4 |
| 12 | DB5 |
| 13 | DB6 |
| 14 | DB7 |
| 15 | CE |
| 16 | RST |
| 17 | Vee |
| 18 | MD2 |
| 19 | FS1 |
| 20 | HLT |

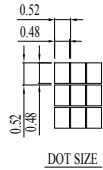

The non-specified tolerance of dimension is ±0.3mm.

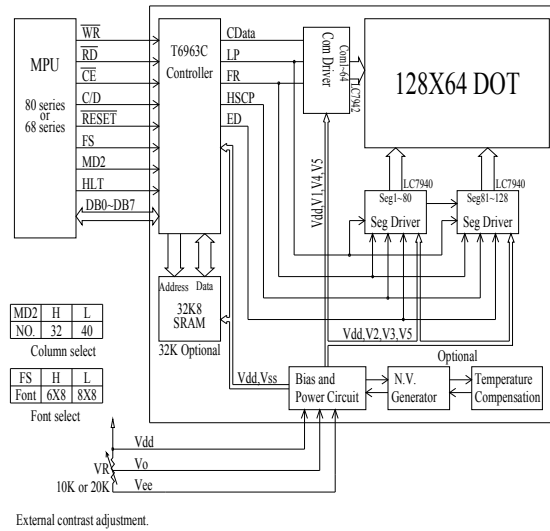

9. Display control instruction

The LCD Module has built in a T6963C LSI controller, It has an 8-bit parallel data bus and control lines for writing or reading through an MPU interface, it has a 128-word character generator ROM (refer to Table 1.), which can control an external display RAM of up to 8K bytes. Allocation of text, graphics and external character generator RAM can be made easily and the display window can be moved freely within the allocated memory range.

•RAM Interface

The external RAM is used to store display data(text, graphic and external CG data). It can be freely allocated to the memory area(8 Kbyte max).

Recommend

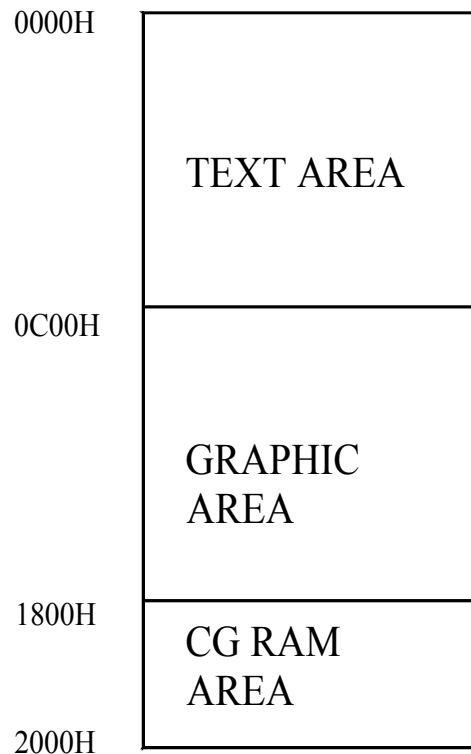

·Flowchart of communications with MPU

(1)Status Read

A status check must be performed before data is read or written.

Status check

The Status of T6963C can be read from the data lines.

| | |
|-----------------|---|
| \overline{RD} | L |
| \overline{WR} | H |
| \overline{CE} | L |
| C/D | H |
| Do to D7 | H |

The T6963C status word format is as follows:

| | | | | | | | |
|------|------|------|------|------|------|------|------|
| MSB | | | | | | | LSB |
| STA7 | STA6 | STA5 | STA4 | STA3 | STA2 | STA1 | STA0 |
| D7 | D6 | D5 | D4 | D3 | D2 | D1 | D0 |

| | | |
|------|--|-----------------------------------|
| STA0 | Check command execution capability | 0:Disable 1:Enable |
| STA1 | Check data read/write Capability | 0:Disable 1:Enable |
| STA2 | Check Auto mode data read capability | 0:Disable 1:Enable |
| STA3 | Check Auto mode data write capability | 0:Disable 1:Enable |
| STA4 | Not used | |
| STA5 | Check controller operation capability | 0:Disable 1:Enable |
| STA6 | Error flag. Used for Screen Peek and Screen copy commands. | 0:No error 1:Error |
| STA7 | Check the blink condition | 0:Disable off 1:Normal display |

(Note 1) It is necessary to check STA0 and STA1 at the same time.

There is a possibility of erroneous operation due to a hardware interrupt.

(Note 2) For most modes STA0/STA1 are used as a status check.

(Note 3) STA2 and STA3 are valid in Auto mode; STA0 and STA1 are invalid.

Status Checking flow

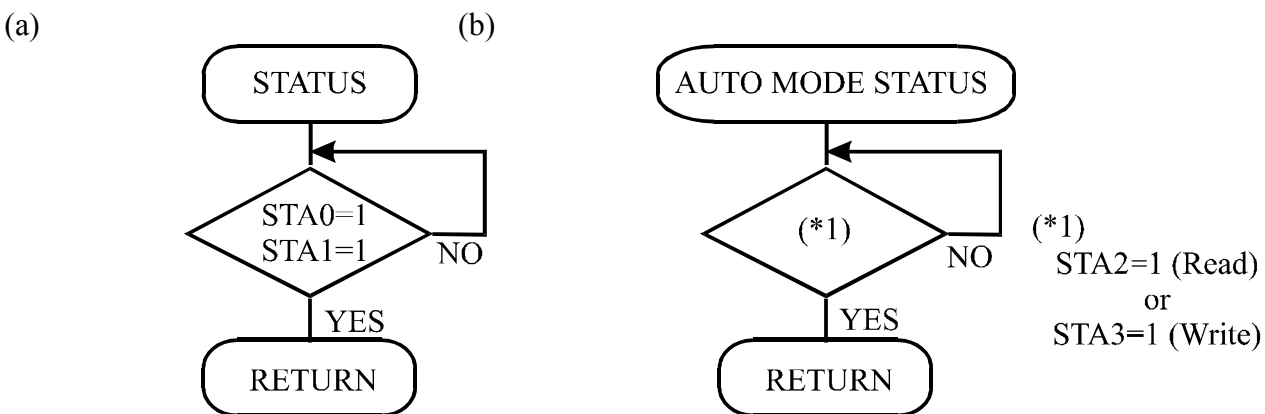

(Note 4) When using the MSB=0 command, a Status Read must be performed.
 If a status check is not carried out, the T6963C cannot operate normally, even after a delay time.
 The hardware interrupt occurs during the address calculation period (at the end of each line).
 If a MSB=0 command is sent to the T6963C during this period, the T6963C enters Wait status.
 If a status check is not carried out in this state before the next command is sent, there is the possibility that the command or data data will not be received.

(2)Setting date

When using the T6963C, first set the data, then set the command.

Procedure for sending a command

(a)The case of 1 date

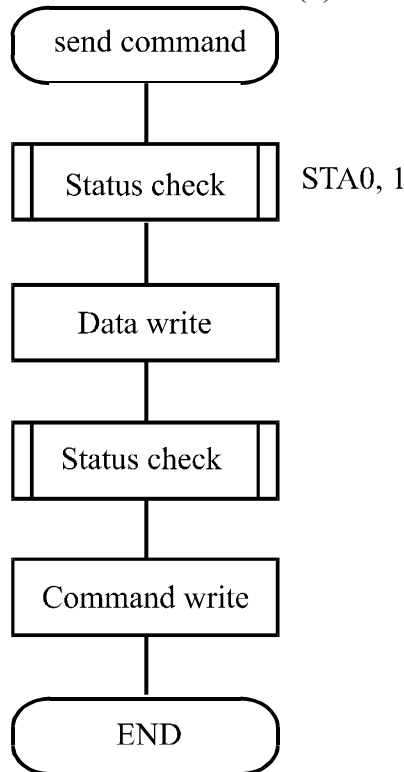

(b)The case of 2 data

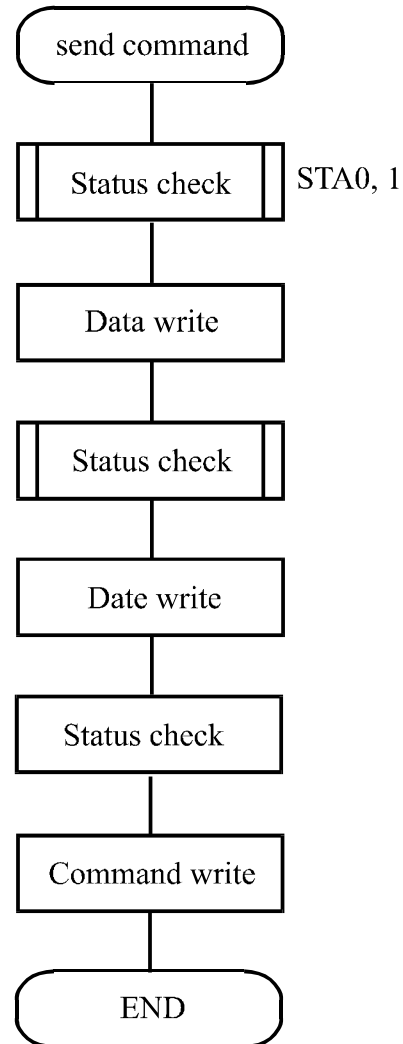

(Note) When sending more than two data, the last datum (or last two data)is valid.

·COMMAND DEFINITIONS

| COMMAND | CODE | D1 | D2 | FUNCTION |
|--------------------------|-----------|-------------|--------------|--------------------------------|
| REGISTERS SETTING | 00100001 | X address | Y address | Set Cursor Pointer |
| | 00100010 | Date | 00H | Set Offset Register |
| | 00100100 | Low address | High address | Set Address Pointer |
| SET CONTROL WORD | 01000000 | Low address | High address | Set Text Home Address |
| | 01000001 | Columns | 00H | Set Text Area |
| | 01000010 | Low address | High address | Set Graphic Home Address |
| | 01000011 | Columns | 00H | Set Graphic Area |
| MODE SET | 1000×000 | — | — | OR mode |
| | 1000×001 | — | — | EXOR mode |
| | 1000×011 | — | — | AND mode |
| | 1000×100 | — | — | Text Attribute mode |
| | 10000××× | — | — | Internal CG ROM mode |
| | 10001××× | — | — | External CG RAM mode |
| DISPLAY MODE | 10010000 | — | — | Display off |
| | 1001××10 | — | — | Cursor on, blink off |
| | 10001××11 | — | — | Cursor on, blink on |
| | 100101×× | — | — | Text on, graphic off |
| | 100110×× | — | — | Text off, graphic on |
| | 100111×× | — | — | Text on, graphic on |
| CURSOR PATTERN SELECT | 10100000 | — | — | 1-line cursor |
| | 10100001 | — | — | 2-line cursor |
| | 10100010 | — | — | 3-line cursor |
| | 10100011 | — | — | 4-line cursor |
| | 10100100 | — | — | 5-line cursor |
| | 10100101 | — | — | 6-line cursor |
| | 10100110 | — | — | 7-line cursor |
| | 10100111 | — | — | 8-line cursor |
| DATA AUTO READ/WRITE | 10110000 | — | — | Set Data Auto Write |
| | 10110001 | — | — | Set Data Auto Read |
| | 10110010 | — | — | Auto Reset |
| DATA READ/WRITE | 11000000 | Data | — | Data Write and Increment ADP |
| | 11000001 | — | — | Data Read and Increment ADP |
| | 11000010 | Data | — | Data Write and Decrement ADP |
| | 11000011 | — | — | Data Read and Decrement ADP |
| | 11000100 | Data | — | Data Write and Nonvariable ADP |
| | 11000101 | — | — | Data Read and Nonvariable ADP |
| SCREEN PEEK | 11100000 | — | — | Screen Peek |

X : invalid

| COMMAND | CODE | D1 | D2 | FUNCTION |
|---------------|-----------|----|----|-------------|
| SCREEN COPY | 11101000 | | | Screen Copy |
| BIT SET/RESET | 11110××× | — | — | Bit Reset |
| | 11111××× | — | — | Bit Set |
| | 1111×000 | — | — | Bit 0 (LSB) |
| | 11111×001 | — | — | Bit 1 |
| | 11111×010 | — | — | Bit 2 |
| | 11111×011 | — | — | Bit 3 |
| | 11111×100 | — | — | Bit 4 |
| | 11111×101 | — | — | Bit 5 |
| | 11111×110 | — | — | Bit 6 |
| | 11111×111 | — | — | Bit 7 (MSB) |

X : invalid

Setting registers

| CODE | HEX. | FUNCTION | D1 | D2 |
|----------|------|---------------------|----------|-----------|
| 00100001 | 21H | SET CURSOR POINTER | X ADRS | Y ADRS |
| 00100010 | 23H | SET OFFSET REGISTER | DATA | 00H |
| 00100100 | 24H | SET ADDRESS POINTER | LOW ADRS | HIGH ADRS |

(1)Set Cursor Pointer

The position of the cursor is specified by X ADRS and Y ADRS. The cursor position can only be moved by this command. Data read/write from the MPU never changes the cursor pointer. X ADRS and Y ADRS are specified as follows.

X ADRS 00H to 4FH (lower 7 bits are valid)

Y ADRS 00H to 1FH (lower 5 bits are valid)

Single-Scan

X ADRS 00 to 4FH

| |
|-------------------|
| Y ADRS 00H to 0FH |
|-------------------|

(2)Set Offset Register

The offset register is used to determine the external character generator RAM area.

The T6963C has a 16-bit address bus as follows.

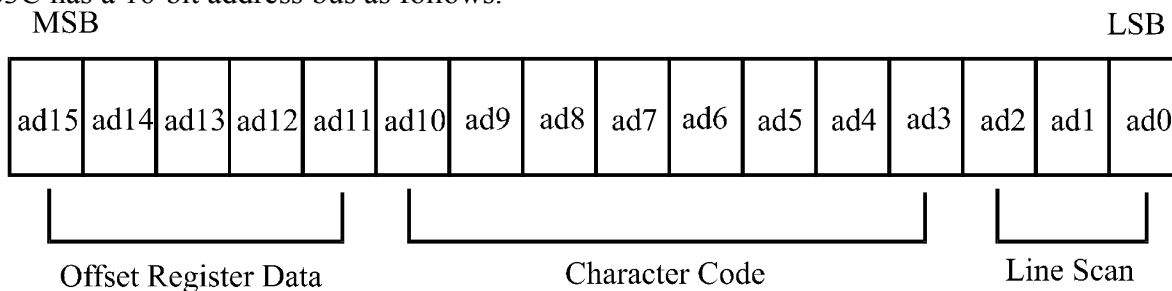

T6963C assign External character generator, when character code set 80H TO FFH in using internal character generator. Character code 00H to 80H assign External character generator, when External generator mode.

The senior five bits define the start address in external memory of the CG RAM area. The next eight bits represent the character code of the character. In internal CG ROM, character codes 00H to 7FH represent the predefined “internal” CG ROM characters, and codes 80H to FFH represent the user’s own “external” characters. In external CG ROM mode, all 256 codes from 00H to FFH can be used to represent the user’s own characters. The three least significant bits indicate one of the eight rows of eight dots that define the character’s shape.









The relationship between display RAM address and offset register

| Offset register data | CG RAM hex. address (start to end) |
|----------------------|------------------------------------|
| 00000 | 0000 to 07 FFH |
| 00001 | 0800 to 0FFFH |
| 00010 | 1000 to 17FFH |
| 11100 | E000 to E7FFH |
| 11101 | E800 to EFFFH |
| 11110 | F000 to F7FFH |
| 11111 | F800 to FFFFH |

(Example 1)

| | |
|---------------------------------------|---------------------|
| Offset register | 02H |
| Character code | 80H |
| Character generator RAM start address | 0001 0100 0000 0000 |

1 4 0 0 H

| | (address) | (data) |
|---|-----------|--------|
|  | 1400H | 00H |
|  | 1401H | 1FH |
|  | 1402H | 04H |
|  | 1403H | 04H |
|  | 1404H | 04H |
|  | 1405H | 04H |
|  | 1406H | 04H |
|  | 1407H | 00H |

(Example 2) The relationship between display RAM data and display characters

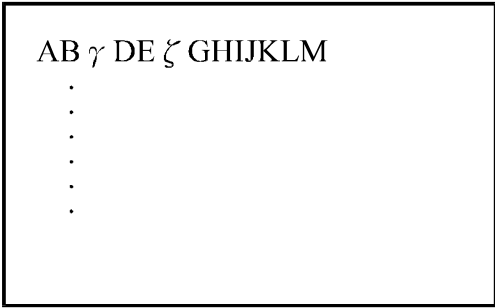
| | (RAM DATA) | (Character) |
|---|------------|-------------|
|  | 21H | A |
| | 22H | B |
| | 83H | γ |
| | 24H | D |
| | 25H | E |
| | 86H | ζ |

Display character

γ and ζ are displayed by character generator RAM.

(3)Set Address Pointer

The Set Address Pointer command is used to indicate the start address for writing to (or reading from)external RAM.

The Flowchart for Set Address Pointer command

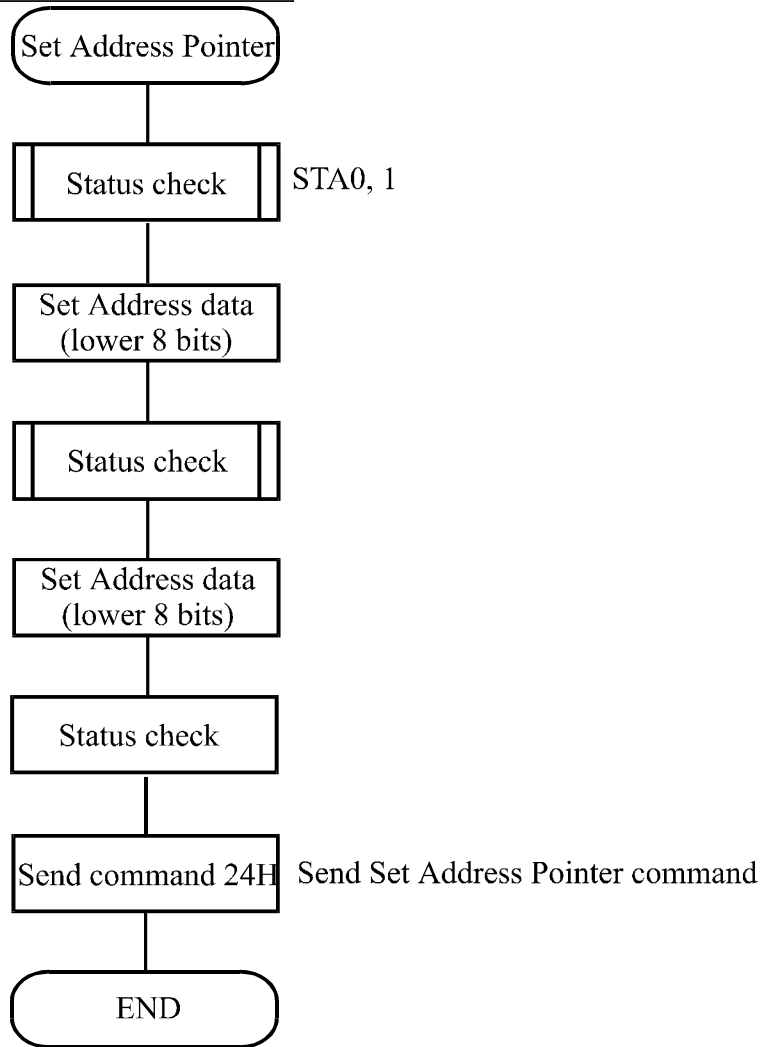

·Set Control Word

| CODE | HEX. | FUNCTION | D1 | D2 |
|----------|------|--------------------------|-------------|--------------|
| 01000000 | 40H | Set Text Home Address | Low address | High address |
| 01000001 | 41H | Set Text Area | Columns | 00H |
| 01000010 | 42H | Set Graphic Home Address | Low address | High address |
| 01000011 | 43H | Set Graphic Area | Columns | 00H |

The home address and column size are defined by this command.

(1)Set Text Home Address

The starting address in the external display RAM for text display is defined by this command.

The text home address indicates the leftmost and uppermost position.

The relationship between external display RAM address and display position

| | | |
|-------------|--|---------------|
| TH | | TH+CL |
| TH+TA | | TH+TA+CL |
| (TH+TA)+TA | | TH+2TA+CL |
| (TH+2TA)+TA | | TH+3TA+CL |
| | | |
| TH+(n-1)TA | | TH+(n-1)TA+CL |

TH:Text home address

TA:Text area number (columns)

CL:Columns are fixed by hardware (pin-programmable).

(Example)

Text home address : 0000H

Text area : 0020H

: 32 Columns

: 4 Lines

| | | | | |
|-------|-------|--|-------|-------|
| 0000H | 0001H | | 001EH | 001FH |
| 0020H | 0021H | | 003EH | 002FH |
| 0040H | 0041H | | 005EH | 005FH |
| 0060H | 0061H | | 007EH | 007FH |

(2)Set Graphic Home Address

The starting address of the external display RAM used for graphic display is defined by this command. The graphic home address indicates the leftmost and uppermost position.

The relationship between external display RAM address and display position

| | | |
|-------------|--|---------------|
| GH | | GH+GL |
| GH+GA | | GH+GA+CL |
| (GH+GA)+GA | | GH+2GA+CL |
| (GH+2GA)+GA | | GH+3GA+CL |
| | | |
| GH+(n-1)GA | | GH+(n-1)GA+CL |

GH:Graphic home address

GA:Graphic area number (columns)

CL:Columns are fixed by hardware (pin-programmable).

(Example)

Graphic home address : 0000H

Graphic area : 0020H

: 32 Columns

: 2 Lines

| | | | | |
|-------|-------|--|-------|-------|
| 0000H | 0001H | | 001EH | 001FH |
| 0020H | 0021H | | 003EH | 003FH |
| 0040H | 0041H | | 005EH | 005FH |
| 0060H | 0061H | | 007EH | 007FH |
| 0080H | 0081H | | 009EH | 009FH |
| 00A0H | 00A1H | | 00BEH | 00BFH |
| 00C0H | 00C1H | | 00DEH | 00DFH |
| 00E0H | 00E1H | | 00FEH | 00FFH |
| 0100H | 0101H | | 011EH | 011FH |
| 0120H | 0121H | | 013EH | 013FH |
| 0140H | 0141H | | 015EH | 014FH |
| 0160H | 0161H | | 017EH | 017FH |
| 0180H | 0181H | | 109EH | 019FH |
| 01A0H | 01A1H | | 01BEH | 01BFH |
| 01C0H | 01C1H | | 01DEH | 01DFH |
| 01E0H | 01E1H | | 01FEH | 01FFH |

(3) Set Text Area

The display columns are defined by the hardware Setting. This command can be used to adjust the columns of the display.

(Example)

```
LCD size           20 columns, 4lines
Text home address  0000H
Text area         0014H
                  Set 32 columns, 4 Lines
```

| | | | | | | |
|------|------|-------|------|------|-------|------|
| 0000 | 0001 | | 0013 | 0014 | | 001F |
| 0014 | 0015 | | 0027 | 0028 | | 0033 |
| 0028 | 0029 | | 003B | 003C | | 0047 |
| 003C | 003D | | 004F | 0050 | | 005B |



(4) Set Graphic Area

The display columns are defined by the hardware setting. This command can be used to adjust the columns of the graphic display.

(Example)

```
LCD size           20 columns, 2lines
Graphic home address : 0000H
Graphic are        : 0014H
                  Set 32 columns, 2 Lines
```

| | | | | | | |
|------|------|-------|------|-------|-------|-------|
| 0000 | 0001 | | 0013 | 0014 | | 001F |
| 0014 | 0015 | | 0027 | 0028 | | 0033 |
| 0028 | 0029 | | 003B | 003C | | 0047 |
| 003C | 003D | | 004F | 0050 | | 005B |
| 0050 | 0051 | | 0063 | 0064 | | 006F |
| 0064 | 0065 | | 0077 | 0078 | | 0083 |
| 0078 | 0079 | | 008B | 008C | | 0097 |
| 008C | 008D | | 009F | 00A0 | | 00AB |
| 00A0 | 00A1 | | 00B3 | 00B4 | | 00BF |
| 00B4 | 00B5 | | 00C7 | 00C8 | | 00D3 |
| 00C8 | 00C9 | | 00DB | 00DC | | 00E7 |
| 00DC | 00DD | | 00EF | 00F0 | | 00FD |
| 00F0 | 00F1 | | 0103 | 0104 | | 011F |
| 0104 | 0105 | | 0127 | 0128 | | 0123 |
| 0128 | 0129 | | 013B | 0013C | | 00147 |
| 013C | 013D | | 014F | 0150 | | 015B |



If the graphic area setting is set to match the desired number of columns on the LCD, the addressing scheme will be automatically modified so that the start address of each line equals the end address of the previous line +1.

·Mode set

| CODE | FUNCTION | OPERAND |
|----------|-----------------------------------|---------|
| 1000×000 | OR Mode | — |
| 1000×001 | EXOR Mode | — |
| 1000×011 | AND Mode | — |
| 1000×100 | TEXT ATTRIBUTE Mode | — |
| 10000××× | Internal Character Generator Mode | — |
| 10001××× | External Character Generator Mode | — |

X:invalid

The display mode is defined by this command. The display mode does not change until the next command is sent. The logical OR, EXOR, AND of text or graphic display can be displayed. In Internal Character Generator mode, character codes 00H to 7FH are assigned to the built-in character generator ROM. The character codes 80H to FFH are automatically assigned to the external character generator RAM.

(Example)

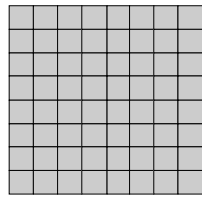

GRAPHIC

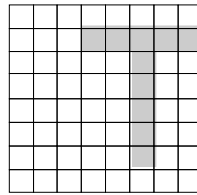

TEXT

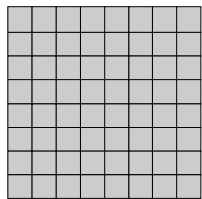

“OR”

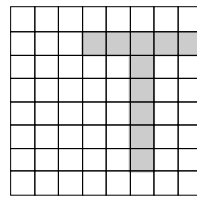

“AND”

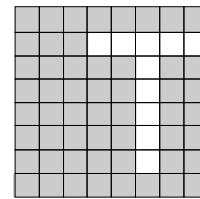

“TXOR”

(Note) Attribute functions can only be applied to text display, since the attribute data is placed in the graphic RAM area.

Attribute function

The attribute operations are Reverse display, Character blink and Inhibit. The attribute data is written into the graphic area which was defined by the Set Control Word command. Only text display is possible in Attribute Function mode; graphic display is automatically disabled. However, the Display Mode command must be used to turn both Text and Graphic on in order for the Attribute function to be available.

The attribute data for each character in the text area is written to the same address in the graphic area. The Attribute function is defined as follows.

Attribute RAM 1byte

| | | | | | | | |
|---|---|---|---|----|----|----|----|
| × | × | × | × | d3 | d2 | d1 | d0 |
|---|---|---|---|----|----|----|----|

| d3 | d2 | d1 | d0 | FUNCTION |
|----|----|----|----|--------------------------|
| 0 | 0 | 0 | 0 | Normal display |
| 0 | 1 | 0 | 1 | Reverse display |
| 0 | 0 | 1 | 1 | Inhibit display |
| 1 | 0 | 0 | 0 | Blink of normal display |
| 1 | 1 | 0 | 1 | Blink of reverse display |
| 1 | 0 | 1 | 1 | Blink of inhibit display |

X:invalid

·Display mode

| CODE | FUNCTION | OPERAND |
|----------|----------------------|---------|
| 10010000 | Display off | — |
| 1001××10 | Cursor on, blink off | — |
| 1001××11 | Cursor on, blink on | — |
| 100101×× | Text on, graphic off | — |
| 100110×× | Text off, graphic on | — |
| 100111×× | Text on, graphic on | — |

X:invalid

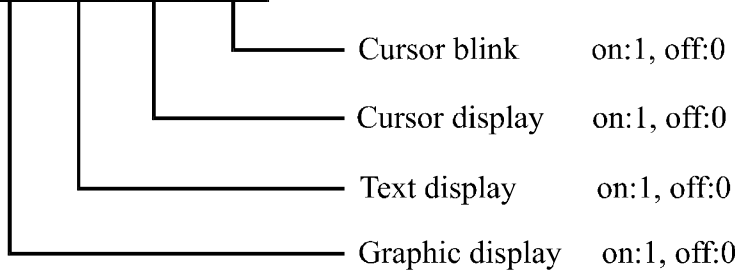
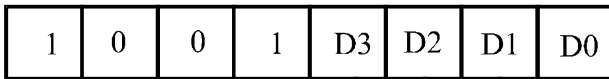

(Note)It is necessary to turn on “Text display” and “Graphic display” in the following cases.

- a)Combination of text/graphic display
- b)Attribute function

·Cursor pattern select

| CODE | FUNCTION | OPERAND |
|----------|---------------|---------|
| 10100000 | 1-line cursor | — |
| 10100001 | 2-line cursor | — |
| 10100010 | 3-line cursor | — |
| 10100011 | 4-line cursor | — |
| 10100100 | 5-line cursor | — |
| 10100101 | 6-line cursor | — |
| 10100110 | 7-line cursor | — |
| 10100111 | 8-line cursor | — |

When cursor display is ON, this command selects the cursor pattern in the range 1 line to 8 lines. The cursor address is defined by the Cursor Pointer Set command.

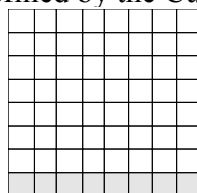

1-line cursor

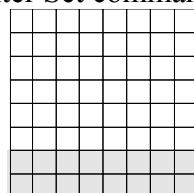

2-line cursor

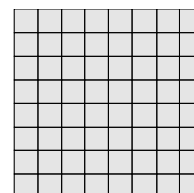

8-line cursor

·Data Auto Read/Write

| CODE | HEX. | FUNCTION | OPERAND |
|----------|------|---------------------|---------|
| 10110000 | B0H | Set Data Auto Write | — |
| 10110001 | B1H | Set Data Auto Read | — |
| 10110010 | B2H | Auto Reset | — |

The command is convenient for sending a full screen of data from the external display RAM. After setting Auto mode, a Data Write (or Read) command is need not be sent between each datum. A Data Auto Write (or Read) command must be sent after a Set Address Pointer command. After this command, the address pointer is automatically incremented by 1 after each datum. In Auto mode, the T6963C cannot accept any other commands.

The Auto Reset command must be sent to the T69963C after all data has been sent, to clear Auto mode.

(Note)A Status check for Auto mode

(STA2, STA3 should be checked between sending of each datum. Auto Reset should be performed after checking STA3=1 (STA2=1.) Refer to the following flowchart.

a)Auto Read mode

b)Auto Write mode

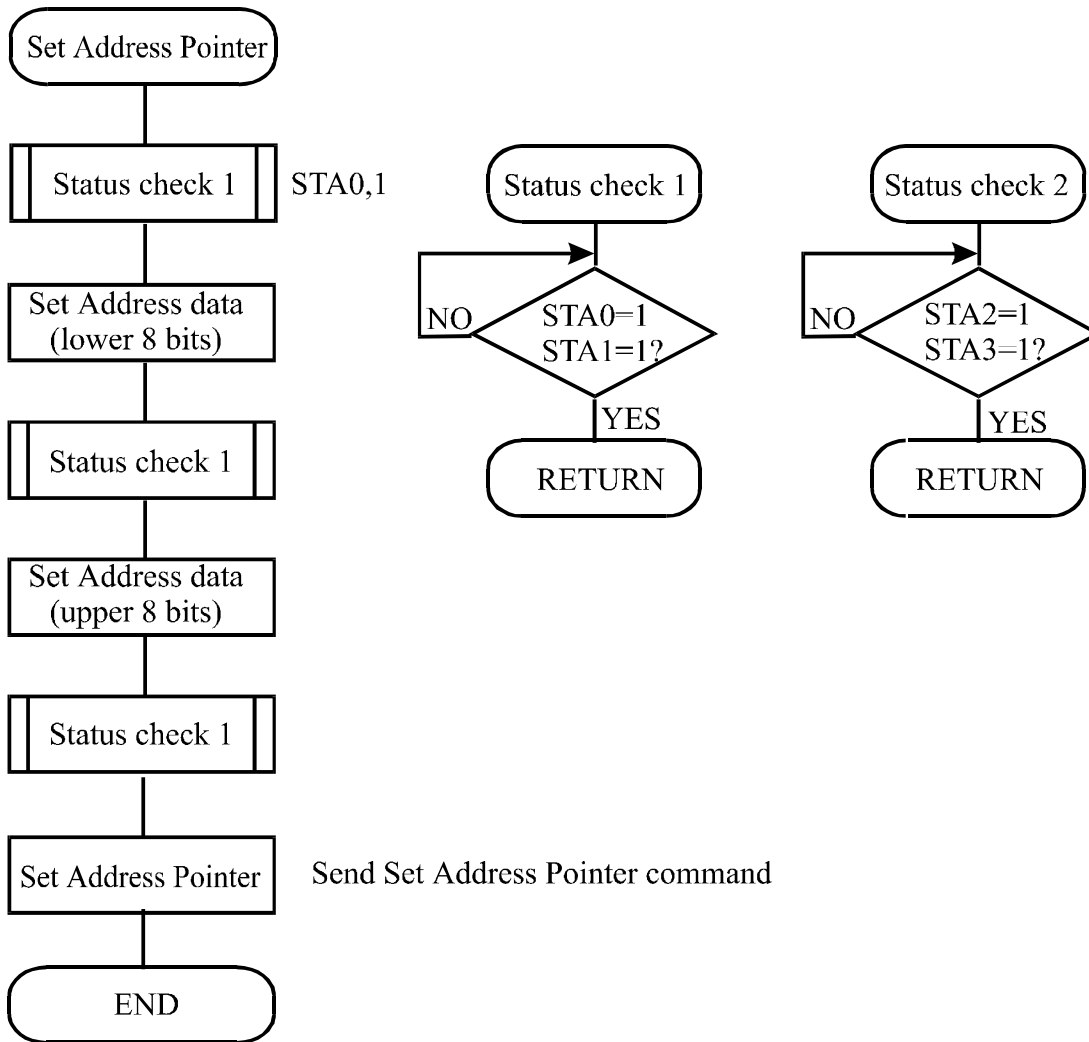

·Date Read/Write

| CODE | HEX. | FUNCTION | OPERAND |
|----------|------|---------------------------------|---------|
| 11000000 | C0H | Data Write and Increment ADP | Data |
| 11000001 | C1H | Data Read and Increment ADP | — |
| 11000010 | C2H | Data Write and Decrement ADP | Data |
| 11000011 | C3H | Data Read and Decrement ADP | — |
| 11000100 | C4H | Data Write and Non variable ADP | Data |
| 11000101 | C5H | Data Read and Non variable ADP | — |

This command is used for writing data from the MPU to external display RAM, and reading data from external display RAM to the MPU. Data Write/Data Read should be executed after setting address using Set Address Pointer command. The address pointer can be automatically incremented or decremented using this command.

(Note) This command is necessary for each 1-byte datum.

Refer to the following flowchart.

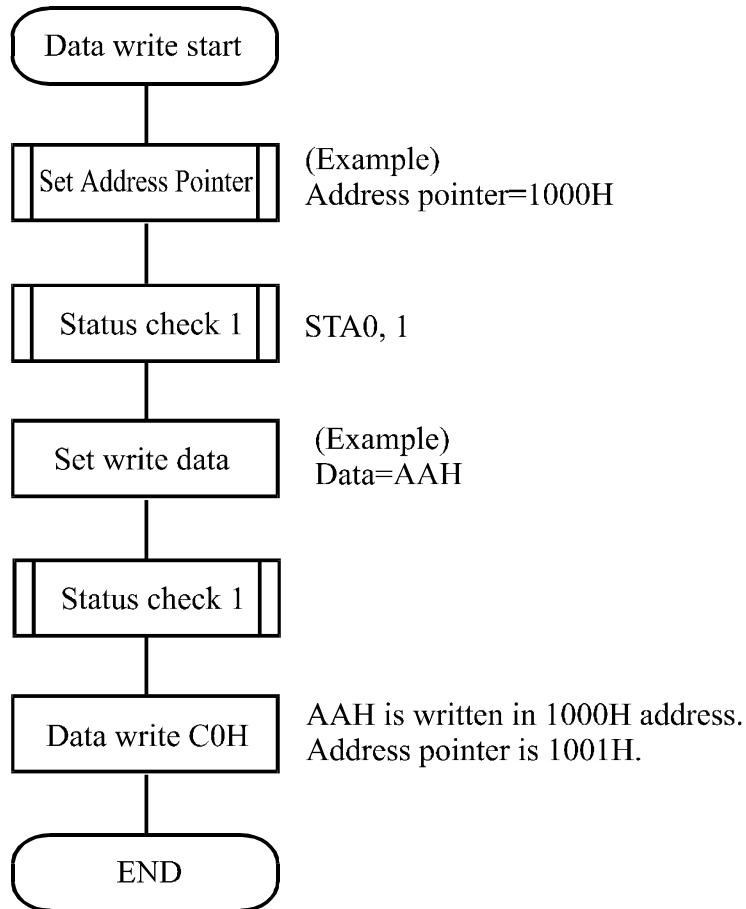

·Screen Peek

| CODE | HEX. | FUNCTION | OPERAND |
|----------|------|-------------|---------|
| 11100000 | E0H | Screen Peek | -e |

This command is used to transfer 1 byte of displayed data to the data stack; this byte can then be read from the MPU by data access. The logical combination of text and graphic display data on the LCD screen can be read by this command.

The status (STA6) should be checked just after the Screen Peek command. If the address determined by the Set Address Pointer command is not in the graphic area, this commands is ignored and a status flag (STA6) is set. Refer to the following flowchart.

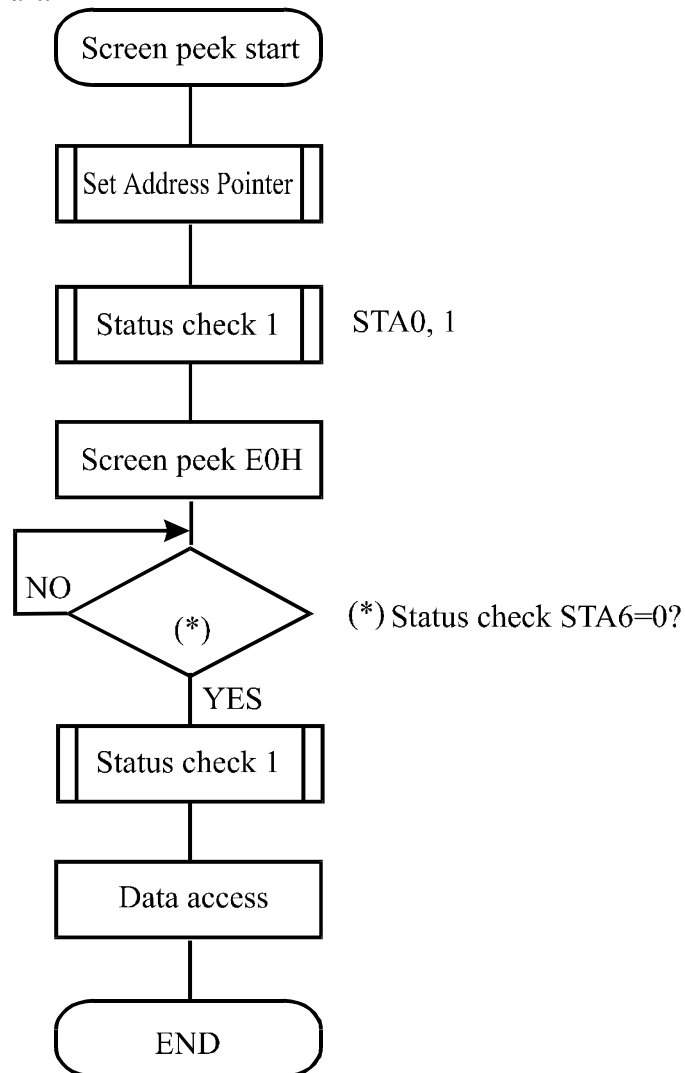

·Screen Copy

| CODE | HEX. | FUNCTION | OPERAND |
|----------|------|-------------|---------|
| 11101000 | E8H | Screen Copy | — |

This command copies a single raster line of data to the graphic area.

The start point must be set using the Set Address Pointer command.

(Note 1) If the attribute function is being used, this command is not available.

(With Attribute data is graphic area data.)

Refer to the following flowchart.

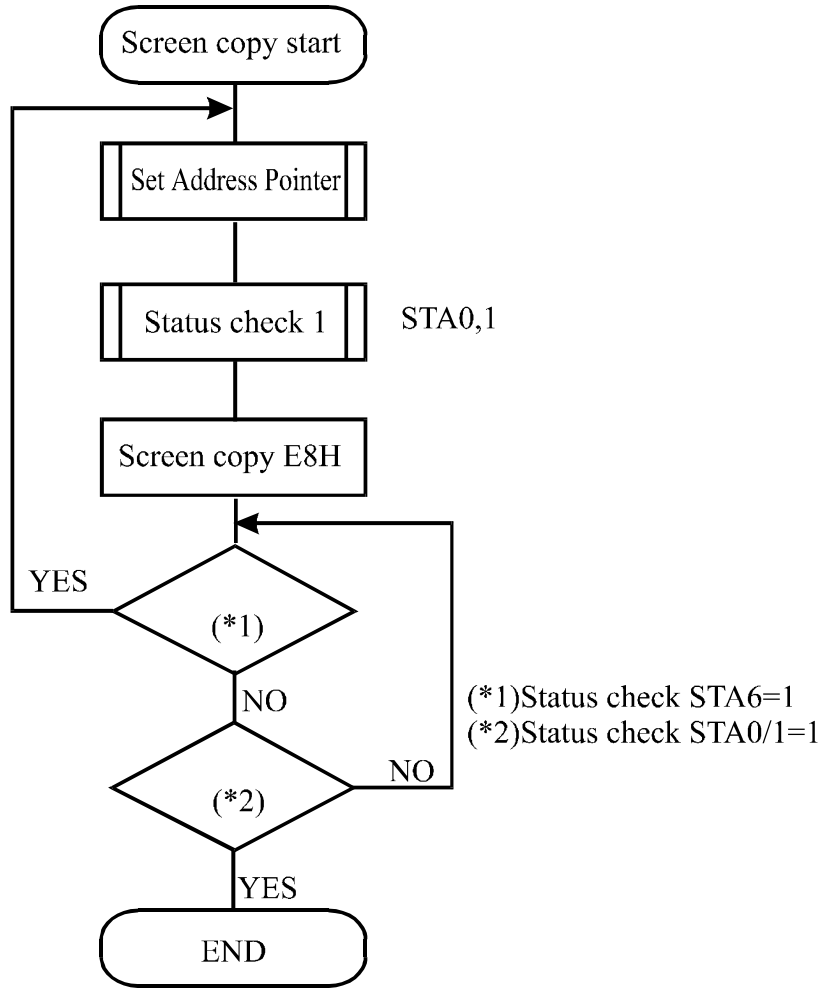

- Bit Set/Reset

| CODE | FUNCTION | OPERAND |
|----------|-------------|---------|
| 11110xxx | Bit Reset | — |
| 11111xxx | Bit Set | — |
| 1111x000 | Bit 0 (LSB) | — |
| 1111x001 | Bit 1 | — |
| 1111x010 | Bit 2 | — |
| 1111x011 | Bit 3 | — |
| 1111x100 | Bit 4 | — |
| 1111x101 | Bit 5 | — |
| 1111x110 | Bit 6 | — |
| 1111x111 | Bit 7 (MSB) | — |

X:invalid

This command use to set or reset a bit of the byte specified by the address pointer.
 Only one bit can be set/reset at a time.
 Refer to the following flowchart.

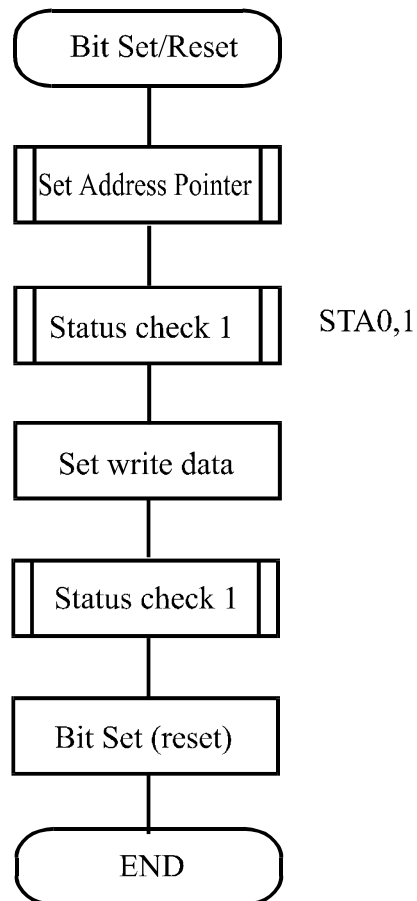

10. Timing Characteristics

Bus Timing

($V_{SS} = 0\text{ V}$, $V_{DD} = 5\text{ V}$)

| Item | Symbol | Min | Typ | Max | Unit |
|------------------------|----------------|-----|-----|-----|------|
| C/D Set-up Time | tCDS | 100 | — | — | ns |
| C/D Hold Time | tCDH | 10 | — | — | ns |
| CE, RD, WR Pulse Width | tCDS, tRD, tWR | 80 | — | — | ns |
| Data Set-up Time | tDS | 80 | — | — | ns |
| Data Hold Time | tDH | 40 | — | — | ns |
| Access Time | tACC | — | — | 150 | ns |
| Output Hold Time | tOH | 10 | — | 50 | ns |

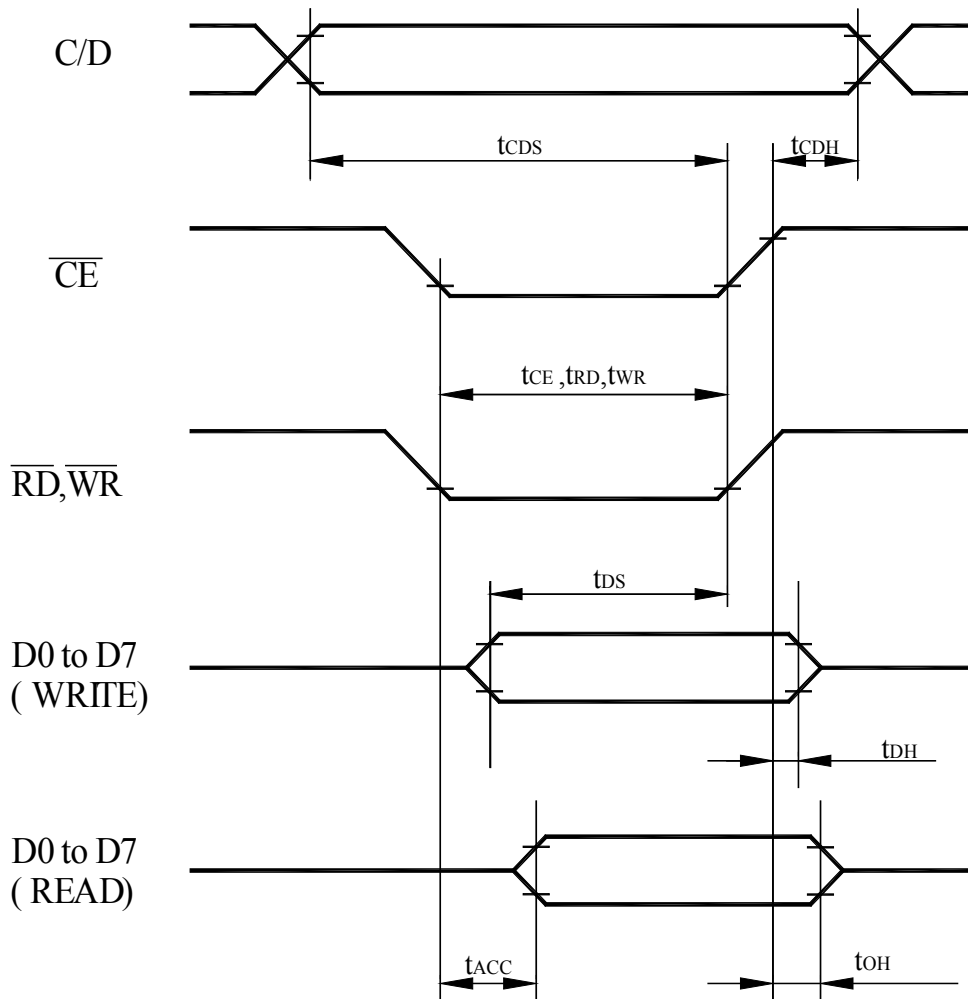

11. RELIABILITY

Content of Reliability Test (wide temperature, -20°C~70°C)

| Environmental Test | | | |
|---|--|--|------|
| Test Item | Content of Test | Test Condition | Note |
| High Temperature storage | Endurance test applying the high storage temperature for a long time. | 80°C 200hrs | 2 |
| Low Temperature storage | Endurance test applying the high storage temperature for a long time. | -30°C 200hrs | 1,2 |
| High Temperature Operation | Endurance test applying the electric stress (Voltage & Current) and the thermal stress to the element for a long time. | 70°C 200hrs | — |
| Low Temperature Operation | Endurance test applying the electric stress under low temperature for a long time. | -20°C 200hrs | 1 |
| High Temperature/ Humidity Operation | The module should be allowed to stand at 60°C,90%RH max For 96hrs under no-load condition excluding the polarizer, Then taking it out and drying it at normal temperature. | 60°C,90%RH 96hrs | 1,2 |
| Thermal shock resistance | The sample should be allowed stand the following 10 cycles of operation -20°C 25°C 70°C 30min 5min 30min 1 cycle | -20°C/70°C 10 cycles | — |
| Vibration test | Endurance test applying the vibration during transportation and using. | Total fixed amplitude : 1.5mm Vibration Frequency : 10~55Hz One cycle 60 seconds to 3 directions of X, Y, Z for Each 15 minutes | 3 |
| Static electricity test | Endurance test applying the electric stress to the terminal. | VS=800V,RS=1.5kΩ CS=100pF 1 time | — |

Note1: No dew condensation to be observed.

Note2: The function test shall be conducted after 4 hours storage at the normal Temperature and humidity after remove from the test chamber.

Note3: Vibration test will be conducted to the product itself without putting it in a container.

12. Backlight Information

Specification

| PARAMETER | SYMBOL | MIN | TYP | MAX | UNIT | TEST CONDITION |
|--------------------|------------------|-----|--------|-----|-------------------|-------------------------|
| Supply Current | I _{LED} | 270 | 330 | 490 | mA | V=4.2V |
| Supply Voltage | V | 4.0 | 4.2 | 4.4 | V | — |
| Reverse Voltage | V _R | — | — | 8 | V | — |
| Luminous Intensity | I _V | 150 | 180 | — | CD/M ² | I _{LED} =330mA |
| Wave Length | λ _p | 565 | 570 | 575 | nm | I _{LED} =330mA |
| Life Time | — | — | 100000 | — | Hr. | I _{LED} ≤330mA |
| Color | Yellow Green | | | | | |

Note: The LED of B/L is drive by current only ; driving voltage is only for reference
To make driving current in safety area (waste current between minimum and maximum).

LED B/L Drive Method

1. Drive from A , K

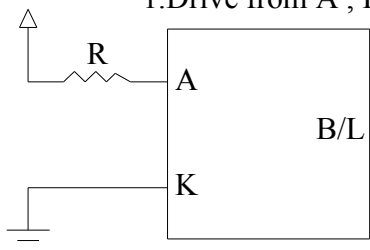

13. Material List of Components for RoHS

1. Crystalfontz America, Inc. hereby declares that all of or part of products (with the mark “#”in code), including, but not limited to, the LCM, accessories or packages, manufactured and/or delivered to your company (including your subsidiaries and affiliated company) directly or indirectly by our company (including our subsidiaries or affiliated companies) do not intentionally contain any of the substances listed in all applicable EU directives and regulations, including the following substances.

Exhibit A:The Harmful Material List

| Material | (Cd) | (Pb) | (Hg) | (Cr6+) | PBBs | PBDEs |
|--|---------|----------|----------|----------|----------|----------|
| Limited Value | 100 ppm | 1000 ppm | 1000 ppm | 1000 ppm | 1000 ppm | 1000 ppm |
| Above limited value is set up according to RoHS. | | | | | | |

2.Process for RoHS requirement:

(1) Use the Sn/Ag/Cu soldering surface ; the surface of Pb-free solder is rougher than we used before.

(2) Heat-resistance temp.

Reflow: 250°C,30 seconds Max.

Connector soldering wave or hand soldering: 320°C, 10 seconds max.

(3) Temp. curve of reflow, max. Temp.: 235±5°C

Recommended customer’s soldering temp. of connector: 280°C, 3 seconds.