

# *Crystalfontz America, Inc.*

## **SPECIFICATION**

**CUSTOMER :** \_\_\_\_\_

**MODULE NO.:**           **CFAH1604B-NGH-ET**          

<b>SALES BY</b>	<b>APPROVED BY</b>	<b>CHECKED BY</b>	<b>PREPARED BY</b>
<b>ISSUED DATE:</b>			

### **Crystalfontz America, Inc.**

12412 East Saltese Avenue  
Spokane Valley, WA 99216-0357

Phone: (888) 206-9720

Fax: (509) 892-1203

Email: [techinfo@crystalfontz.com](mailto:techinfo@crystalfontz.com)

URL: [www.crystalfontz.com](http://www.crystalfontz.com)

# Contents

1. Module Classification Information
2. Precautions in use of LCD Modules
3. General Specification
4. Absolute Maximum Ratings
5. Electrical Characteristics
6. Optical Characteristics
7. Interface Pin Function
8. Contour Drawing & Block Diagram
9. Function Description
10. Character Generator ROM Pattern
11. Instruction Table
12. Timing Characteristics
13. Initializing of LCM
14. Reliability
15. Material List of Components for RoHs

# **1.Module Classification Information**

CFA H 1604 B N G H ET  
 ① ② ③ ④ ⑤ ⑥ ⑦ ⑧

①	Brand: <b>CRYSTALFONTZ AMERICA, INC</b>	
②	Display Type: <b>H</b> →Character Type, <b>G</b> →Graphic Type	
③	Displays Logical Dimensions: <b>16 Characters x 4 Lines</b>	
④	Model PCB Variant: <b>B</b>	
⑤	Backlight Type:	<b>N</b> →Without backlight <b>B</b> →EL, Blue green <b>D</b> →EL, Green <b>W</b> →EL, White <b>F</b> →CCFL, White <b>Y</b> →LED, Yellow Green <b>T</b> →LED, White <b>A</b> →LED, Amber <b>R</b> →LED, Red <b>O</b> →LED, Orange <b>G</b> →LED, Green
⑥	LCD Mode:	<b>B</b> →TN Positive, Gray <b>T</b> →FSTN Negative <b>N</b> →TN Negative, <b>G</b> → <b>STN Positive, Gray</b> <b>Y</b> →STN Positive, Yellow Green <b>M</b> →STN Negative, Blue <b>F</b> →FSTN Positive
⑦	LCD Polarizer Type/ Temperature range/ View direction	<b>A</b> →Reflective, N.T, 6:00 <b>H</b> → <b>Transflective, W.T,6:00</b> <b>D</b> →Reflective, N.T, 12:00 <b>K</b> →Transflective, W.T,12:00 <b>G</b> →Reflective, W. T, 6:00 <b>C</b> →Transmissive, N.T,6:00 <b>J</b> →Reflective, W. T, 12:00 <b>F</b> →Transmissive, N.T,12:00 <b>B</b> →Transflective, N.T,6:00 <b>I</b> →Transmissive, W. T, 6:00 <b>E</b> →Transflective, N.T.12:00 <b>L</b> →Transmissive, W.T,12:00
⑧	Special Code	<b>ET</b> → <b>English and European standard font ;</b>

## **2.Precautions in use of LCD Modules**

- (1) Avoid applying excessive shocks to the module or making any alterations or modifications to it.
- (2) Don't make extra holes on the printed circuit board, modify its shape or change the components of LCD module.
- (3) Don't disassemble the LCM.
- (4) Don't operate it above the absolute maximum rating.
- (5) Don't drop, bend or twist LCM.
- (6) Soldering: only to the I/O terminals.
- (7) Storage: please storage in anti-static electricity container and clean environment.

## **3.General Specification**

<b>Item</b>	<b>Dimension</b>	<b>Unit</b>
Number of Characters	16 characters x 4 Lines	□
Module dimension	70.6 x 60.0 x 8.4(MAX)	mm
View area	60.0 x 32.6	mm
Active area	56.2 x 20.8	mm
Dot size	0.55 x 0.55	mm
Dot pitch	0.60 x 0.60	mm
Character size	2.95 x 4.75	mm
Character pitch	3.55 x 5.35	mm
LCD type	STN Positive, Transflective, Gray	
Duty	1/16	
View direction	6 o'clock	
Backlight Type	N/A	

## **4. Absolute Maximum Ratings**

Item	Symbol	Min	Typ	Max	Unit
Operating Temperature	$T_{OP}$	-20	□	+70	°C
Storage Temperature	$T_{ST}$	-30	□	+80	°C
Input Voltage	$V_I$	$V_{SS}$	□	$V_{DD}$	V
Supply Voltage For Logic	$V_{DD}-V_{SS}$	-0.3	□	7	V
Supply Voltage For LCD	$V_{DD}-V_0$	-0.3	□	13	V

## **5. Electrical Characteristics**

Item	Symbol	Condition	Min	Typ	Max	Unit
Supply Voltage For Logic	$V_{DD}-V_{SS}$	□	4.5	5.0	5.5	V
Supply Voltage For LCD	$V_{DD}-V_0$	$T_a=-20^{\circ}\text{C}$	□	□	5.6	V
		$T_a=25^{\circ}\text{C}$	□	4.2	□	V
		$T_a=70^{\circ}\text{C}$	□	□	□	V
			3.4	□		
Input High Volt.	$V_{IH}$	□	$0.7 V_{DD}$	□	$V_{DD}$	V
Input Low Volt.	$V_{IL}$	□	$V_{SS}$	□	0.6	V
Output High Volt.	$V_{OH}$	□	3.9	□	□	V
Output Low Volt.	$V_{OL}$	□	□	□	0.4	V
Supply Current	$I_{DD}$	$V_{DD}=5.0\text{V}$	1.0	1.2	1.5	mA

## 6. Optical Characteristics

Item	Symbol	Condition	Min	Typ	Max	Unit
View Angle	(V) $\theta$	CR $\geq$ 2	20	$\square$	40	deg
	(H) $\phi$	CR $\geq$ 2	-30	$\square$	30	deg
Contrast Ratio	CR	$\square$	$\square$	3	$\square$	$\square$
Response Time	T rise	$\square$	$\square$	200	300	ms
	T fall	$\square$	$\square$	200	300	ms

Definition of Operation Voltage (Vop)

Definition of Response Time (Tr, Tf)

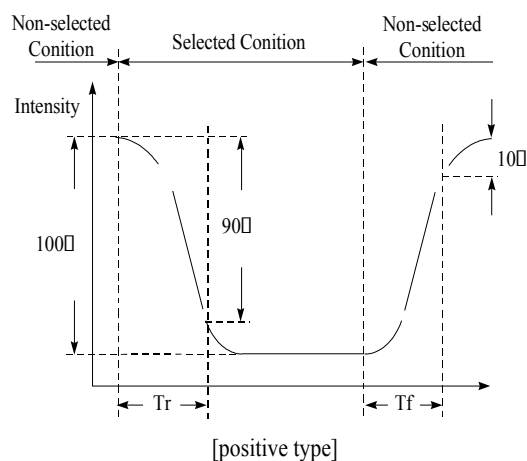
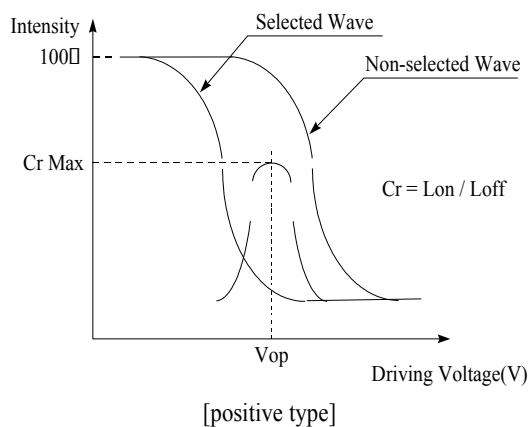

Conditions :

Operating Voltage : Vop

Viewing Angle( $\theta$  /  $\phi$ ) : 0° ~ 0°

Frame Frequency : 64 HZ

Driving Waveform : 1/N duty , 1/a bias

Definition of viewing angle(CR $\geq$ 2)

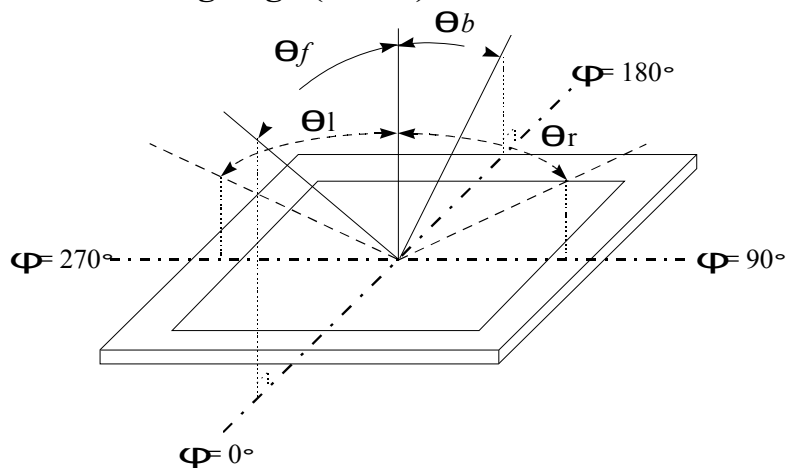

## **7.Interface Pin Function**

<b>Pin No.</b>	<b>Symbol</b>	<b>Level</b>	<b>Description</b>
1	V <sub>SS</sub>	0V	Ground
2	V <sub>DD</sub>	5.0V	Supply Voltage for logic
3	VO	(Variable)	Operating voltage for LCD
4	RS	H/L	H: DATA, L: Instruction code
5	R/W	H/L	H: Read(MPU→Module) L: Write(MPU→Module)
6	E	H,H→L	Chip enable signal
7	DB0	H/L	Data bus line
8	DB1	H/L	Data bus line
9	DB2	H/L	Data bus line
10	DB3	H/L	Data bus line
11	DB4	H/L	Data bus line
12	DB5	H/L	Data bus line
13	DB6	H/L	Data bus line
14	DB7	H/L	Data bus line
15	A		LED+
16	K		LED-

# 8. Contour Drawing & Block Diagram

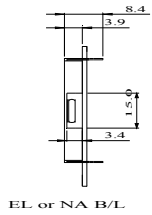
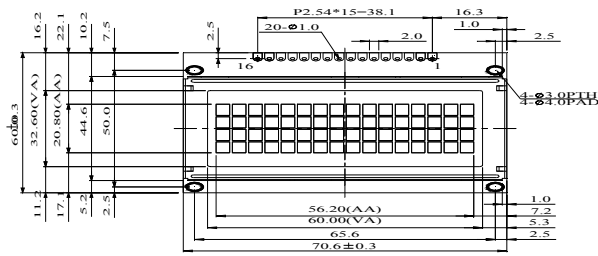

PIN NO.	SYMBOL
1	Vss
2	Vdd
3	Vo
4	RS
5	R/W
6	E
7	DB0
8	DB1
9	DB2
10	DB3
11	DB4
12	DB5
13	DB6
14	DB7
15	A/Vee
16	K

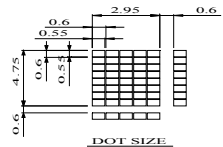

The non-specified tolerance of dimension is ±0.3mm.

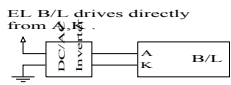
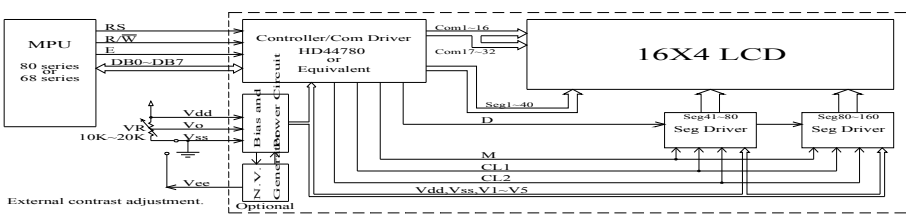

Character located	1	2	3	4	5	6	7	8	9	10	11	12	13	14	15	16
DDRAM address	00	01	02	03	04	05	06	07	08	09	0A	0B	0C	0D	0E	0F
DDRAM address	40	41	42	43	44	45	46	47	48	49	4A	4B	4C	4D	4E	4F
DDRAM address	10	11	12	13	14	15	16	17	18	19	1A	1B	1C	1D	1E	1F
DDRAM address	50	51	52	53	54	55	56	57	58	59	5A	5B	5C	5D	5E	5F

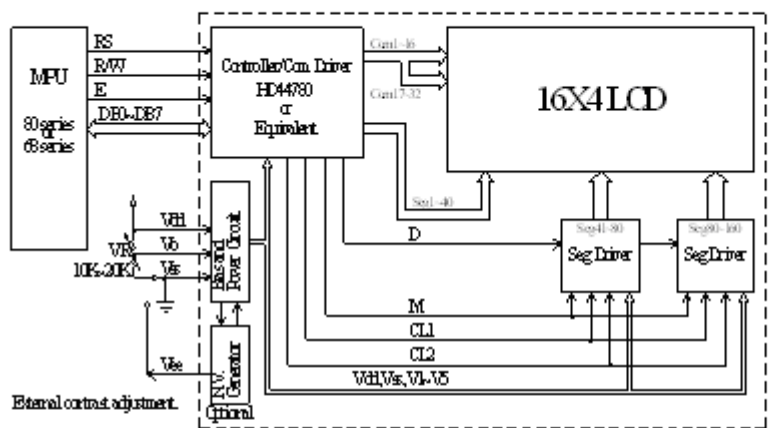

Character located	1	2	3	4	5	6	7	8	9	10	11	12	13	14	15	16
DDRAM address	00	01	02	03	04	05	06	07	08	09	0A	0B	0C	0D	0E	0F
DDRAM address	40	41	42	43	44	45	46	47	48	49	4A	4B	4C	4D	4E	4F
DDRAM address	10	11	12	13	14	15	16	17	18	19	1A	1B	1C	1D	1E	1F
DDRAM address	50	51	52	53	54	55	56	57	58	59	5A	5B	5C	5D	5E	5F



## 9. Function Description

The LCD display Module is built in a LSI controller, the controller has two 8-bit registers, an instruction register (IR) and a data register (DR).

The IR stores instruction codes, such as display clear and cursor shift, and address information for display data RAM (DDRAM) and character generator (CGRAM). The IR can only be written from the MPU. The DR temporarily stores data to be written or read from DDRAM or CGRAM. When address information is written into the IR, then data is stored into the DR from DDRAM or CGRAM. By the register selector (RS) signal, these two registers can be selected.

RS	R/W	Operation
0	0	IR write as an internal operation (display clear, etc.)
0	1	Read busy flag (DB7) and address counter (DB0 to DB7)
1	0	Write data to DDRAM or CGRAM (DR to DDRAM or CGRAM)
1	1	Read data from DDRAM or CGRAM (DDRAM or CGRAM to DR)

### Busy Flag (BF)

When the busy flag is 1, the controller LSI is in the internal operation mode, and the next instruction will not be accepted. When RS=0 and R/W=1, the busy flag is output to DB7. The next instruction must be written after ensuring that the busy flag is 0.

### Address Counter (AC)

The address counter (AC) assigns addresses to both DDRAM and CGRAM

### Display Data RAM (DDRAM)

This DDRAM is used to store the display data represented in 8-bit character codes. Its extended capacity is 80×8 bits or 80 characters. Below figure is the relationships between DDRAM addresses and positions on the liquid crystal display.

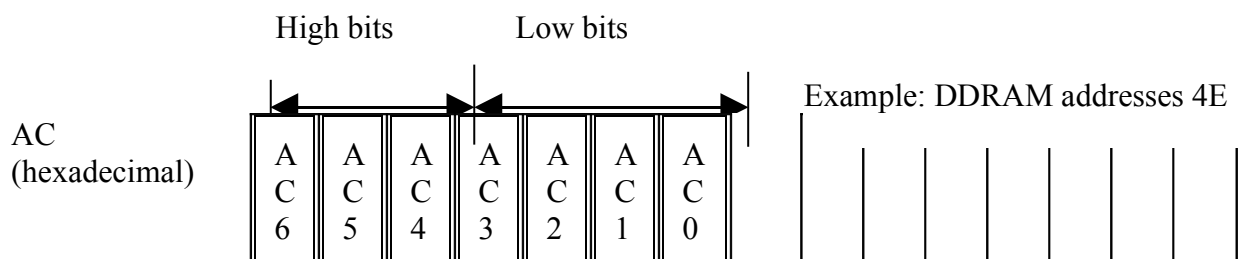

### Display position DDRAM address

1 2 3 4 5 6 7 8 9 10 11 12 13 14 15 16

00	01	02	03	04	05	06	07	08	09	0A	0B	0C	0D	0E	0F
40	41	42	43	44	45	46	47	48	49	4A	4B	4C	4D	4E	4F
10	11	12	13	14	15	16	17	18	19	1A	1B	1C	1D	1E	1F
50	51	52	53	54	55	56	57	58	59	5A	5B	5C	5D	5E	5F

4-Line by 16-Character Display

### Character Generator ROM (CGROM)

The CGROM generate  $5 \times 8$  dot or  $5 \times 10$  dot character patterns from 8-bit character codes. See Table 2.

### Character Generator RAM (CGRAM)

In CGRAM, the user can rewrite character by program. For  $5 \times 8$  dots, eight character patterns can be written, and for  $5 \times 10$  dots, four character patterns can be written.

Write into DDRAM the character code at the addresses shown as the left column of table 1. To show the character patterns stored in CGRAM.

# Relationship between CGRAM Addresses, Character Codes (DDRAM) and Character patterns

Table 1.

For 5 \* 8 dot character patterns

Character Codes ( DDRAM data )		CGRAM Address		Character Patterns ( CGRAM data )		
7 6 5 4 3 2 1 0		5 4 3 2 1 0		7 6 5 4 3 2 1 0		
High Low		High Low		High Low		
0 0 0 0 * 0 0 0		0 0 0	0 0 0	* * *	0	Character pattern( 1 )
			0 0 1	* * *	0 0 0	
			0 1 0	* * *	0 0 0	
			0 1 1	* * *	0	
			1 0 0	* * *	0 0 0	
			1 0 1	* * *	0 0 0	
			1 1 0	* * *	0 0 0	
			1 1 1	* * *	0 0 0 0 0	
			0 0 0	* * *	0 0 0 0	
			0 0 1	* * *	0 0 0	
0 0 0 0 * 0 0 1		0 0 1	0 1 0	* * *	0	Character pattern( 2 )
			0 1 1	* * *	0 0	
			1 0 0	* * *	0 0	
			1 0 1	* * *	0 0 0 0	
			1 1 0	* * *	0 0 0 0	
			1 1 1	* * *	0 0 0 0	
			0 0 0	* * *	0 0 0 0 0	
			0 0 1	* * *	0 0 0	
			0 1 0	* * *	0 0 0 0	
			0 1 1	* * *	0 0 0 0	
			0 0 0	* * *		Cursor pattern
			0 0 1	* * *		
0 0 0 0 * 1 1 1		1 1 1	1 0 0			
			1 0 1			
			1 1 0			
			1 1 1	* * *		

For 5 \* 10 dot character patterns

Character Codes ( DDRAM data )		CGRAM Address		Character Patterns ( CGRAM data )		
7 6 5 4 3 2 1 0		5 4 3 2 1 0		7 6 5 4 3 2 1 0		
High Low		High Low		High Low		
0 0 0 0 * 0 0 0		0 0	0 0 0 0	* * *	0 0 0 0 0	Character pattern
			0 0 0 1	* * *	0 0 0 0 0	
			0 0 1 0	* * *	0	
			0 0 1 1	* * *	0 0	
			0 1 0 0	* * *	0 0 0	
			0 1 0 1	* * *	0 0 0	
			0 1 1 0	* * *	0	
			0 1 1 1	* * *	0 0 0 0	
			1 0 0 0	* * *	0 0 0 0	
			1 0 0 1	* * *	0 0 0 0	
1 0 1 0	* * *	0 0 0 0				
						Cursor pattern
			1 1 1 1	* * *	* * * * *	

■ : " High "

# 10.Character Generator ROM Pattern

Table.2

Upper 4 bit Lower 4 bit	LLLL	LLLH	LLHL	LLHH	LHLL	LHLH	LHHL	LHHH	HLLL	HLLH	HLHL	HLHH	HHLL	HHLH	HHHL	HHHH
LLLL	CG RAM (1)	!	"	#	\$	%	&	'	(	)	*	+	,	-	.	:
LLLH	CG RAM (2)	;	<	=	>	?@	AB	CD	EF	GH	IK	LM	NO	PQ	RS	TU
LLHL	CG RAM (3)	V	W	X	Y	Z	[	]	^	_	`	a	b	c	d	e
LLHH	CG RAM (4)	f	g	h	i	j	k	l	m	n	o	p	q	r	s	t
LHLL	CG RAM (5)	u	v	w	x	y	z	{	}	~	!	"	#	\$	%	&
LHLH	CG RAM (6)	'	(	)	*	+	,	-	.	:	;	<	=	>	?@	AB
LHHL	CG RAM (7)	CD	EF	GH	IK	LM	NO	PQ	RS	TU	V	W	X	Y	Z	[
LHHH	CG RAM (8)	]	^	_	`	a	b	c	d	e	f	g	h	i	j	k
HLLL	CG RAM (1)	l	m	n	o	p	q	r	s	t	u	v	w	x	y	z
HLLH	CG RAM (2)	{	}	~	!	"	#	\$	%	&	'	(	)	*	+	,
HLHL	CG RAM (3)	-	.	:	;	<	=	>	?@	AB	CD	EF	GH	IK	LM	NO
HLHH	CG RAM (4)	PQ	RS	TU	V	W	X	Y	Z	[	]	^	_	`	a	b
HHLL	CG RAM (5)	c	d	e	f	g	h	i	j	k	l	m	n	o	p	q
HHLH	CG RAM (6)	r	s	t	u	v	w	x	y	z	{	}	~	!	"	#
HHHL	CG RAM (7)	'	(	)	*	+	,	-	.	:	;	<	=	>	?@	AB
HHHH	CG RAM (8)	CD	EF	GH	IK	LM	NO	PQ	RS	TU	V	W	X	Y	Z	[

# 11. Instruction Table

Instruction	Instruction Code										Description	Execution time (fosc=270Khz)	
	RS	R/W	DB7	DB6	DB5	DB4	DB3	DB2	DB1	DB0			
Clear Display	0	0	0	0	0	0	0	0	0	1	Write "00H" to DDRAM and set DDRAM address to "00H" from AC	1.53ms	
Return Home	0	0	0	0	0	0	0	0	0	1	Set DDRAM address to "00H" from AC and return cursor to its original position if shifted. The contents of DDRAM are not changed.	1.53ms	
Entry Mode Set	0	0	0	0	0	0	0	0	1	I/D	SH	Assign cursor moving direction and enable the shift of entire display.	39μs
Display ON/OFF Control	0	0	0	0	0	0	0	1	D	C	B	Set display (D), cursor (C), and blinking of cursor (B) on/off control bit.	39μs
Cursor or Display Shift	0	0	0	0	0	0	1	S/C	R/L	□	□	Set cursor moving and display shift control bit, and the direction, without changing of DDRAM data.	39μs
Function Set	0	0	0	0	1	DL	N	F	□	□	□	Set interface data length (DL:8-bit/4-bit), numbers of display line (N:2-line/1-line)and, display font type (F:5×11 dots/5×8 dots)	39μs
Set CGRAM Address	0	0	0	1	AC5	AC4	AC3	AC2	AC1	AC0	Set CGRAM address in address counter.	39μs	
Set DDRAM Address	0	0	1	AC6	AC5	AC4	AC3	AC2	AC1	AC0	Set DDRAM address in address counter.	39μs	
Read Busy Flag and Address	0	1	BF	AC6	AC5	AC4	AC3	AC2	AC1	AC0	Whether during internal operation or not can be known by reading BF. The contents of address counter can also be read.	0μs	
Write Data to RAM	1	0	D7	D6	D5	D4	D3	D2	D1	D0	Write data into internal RAM (DDRAM/CGRAM).	43μs	
Read Data from RAM	1	1	D7	D6	D5	D4	D3	D2	D1	D0	Read data from internal RAM (DDRAM/CGRAM).	43μs	

□ "□"□ don't care

# 12. Timing Characteristics

## 12.1 Write Operation

- Writing data from MPU

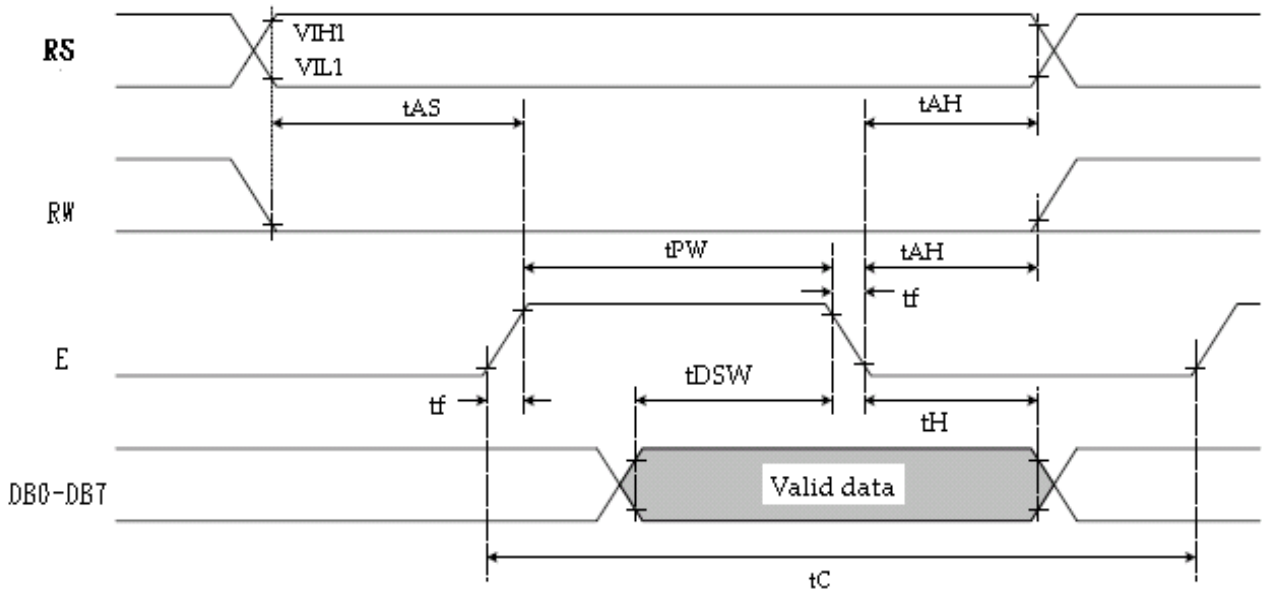

$T_a=25^\circ\text{C}$ ,  $V_{DD}=5.0\text{ V}$

Item	Symbol	Min	Typ	Max	Unit
Enable cycle time	$T_C$	1200	□	□	ns
Enable pulse width	$T_{PW}$	140	□	□	ns
Enable rise/fall time	$T_R, T_F$	□	□	25	ns
Address set-up time (RS, R/W to E)	$t_{AS}$	0	□	□	ns
Address hold time	$t_{AH}$	10	□	□	ns
Data set-up time	$t_{DSW}$	40	□	□	ns
Data hold time	$t_H$	10	□	□	ns

## 12.2 Read Operation

- Reading data from ST7066U

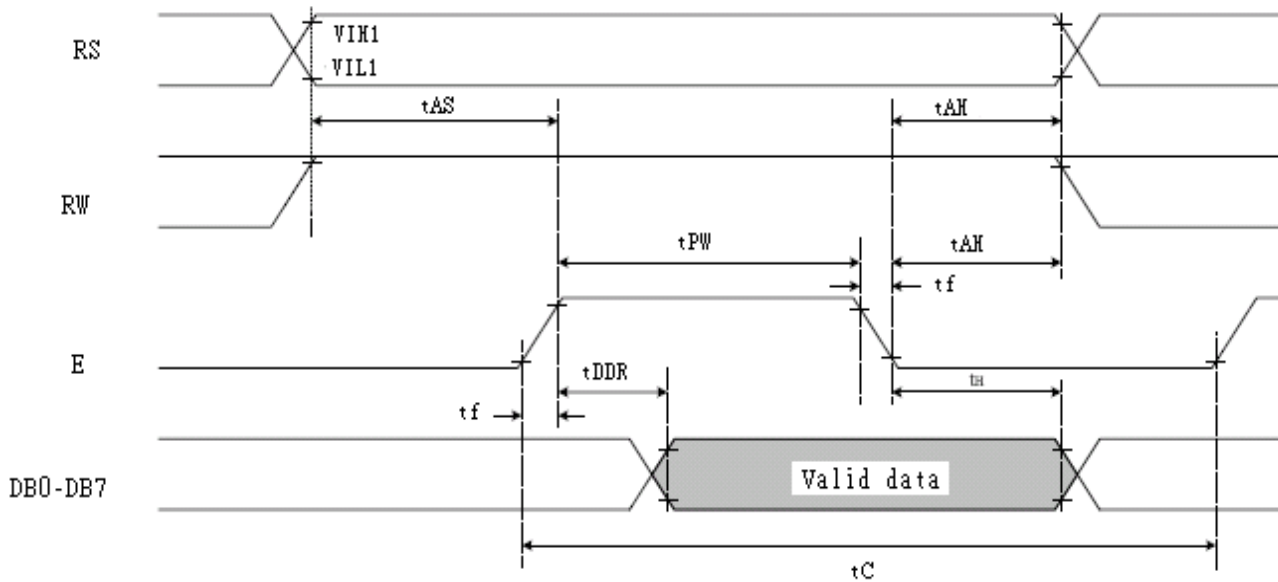

$T_a=25^\circ$ ,  $V_{DD}=5v$

Item	Symbol	Min	Typ	Max	Unit
Enable cycle time	$T_C$	1200	□	□	ns
Enable pulse width (high level)	$T_{PW}$	140	□	□	ns
Enable rise/fall time	$T_R, T_F$	□	□	25	ns
Address set-up time (RS, R/W to E)	$t_{AS}$	0	□	□	ns
Address hold time	$t_{AH}$	10	□	□	ns
Data delay time	$t_{DDR}$	□	□	100	ns
Data hold time	$t_H$	10	□	□	ns

# 13. Initializing of LCM

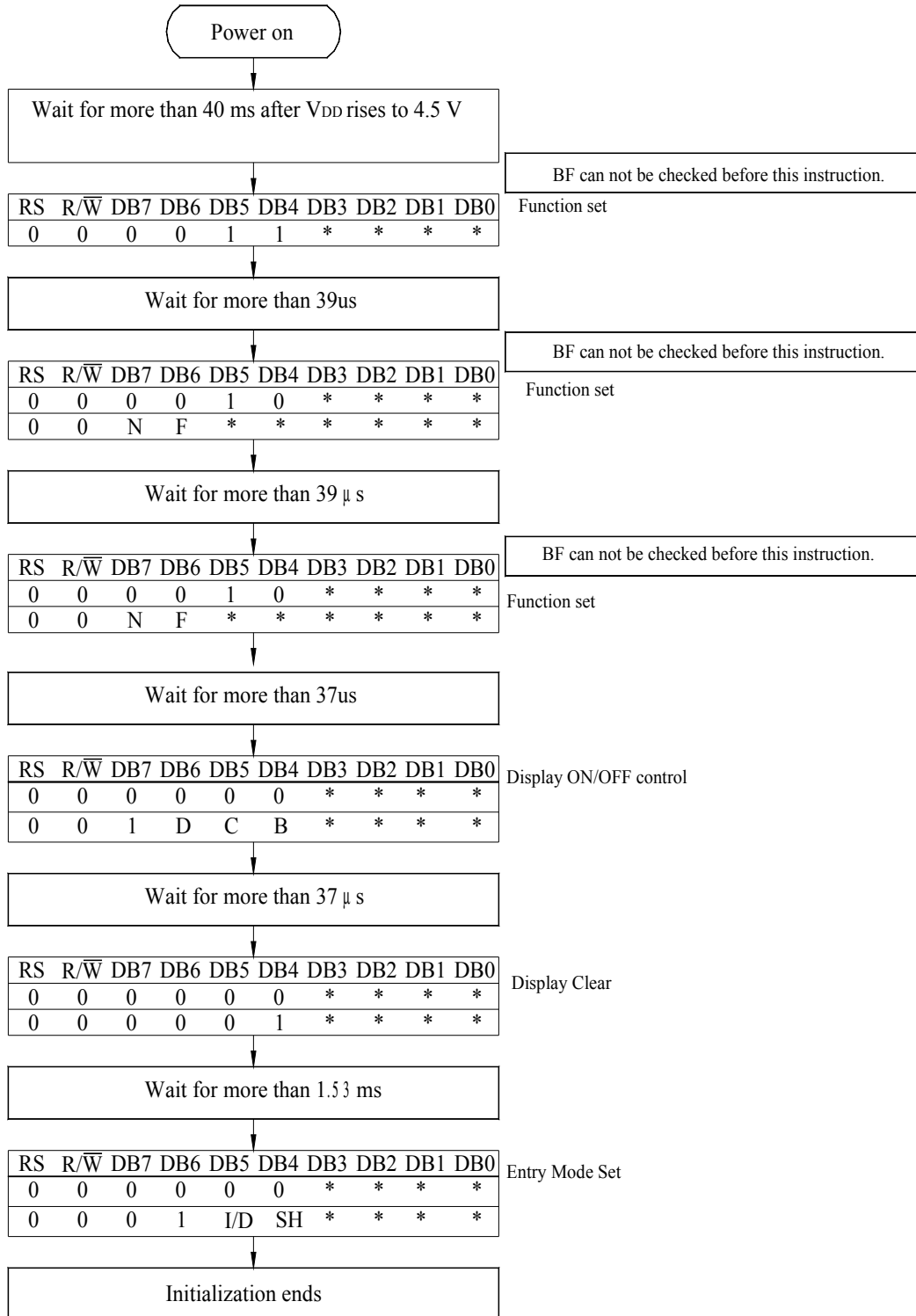

4-Bit Ineterface



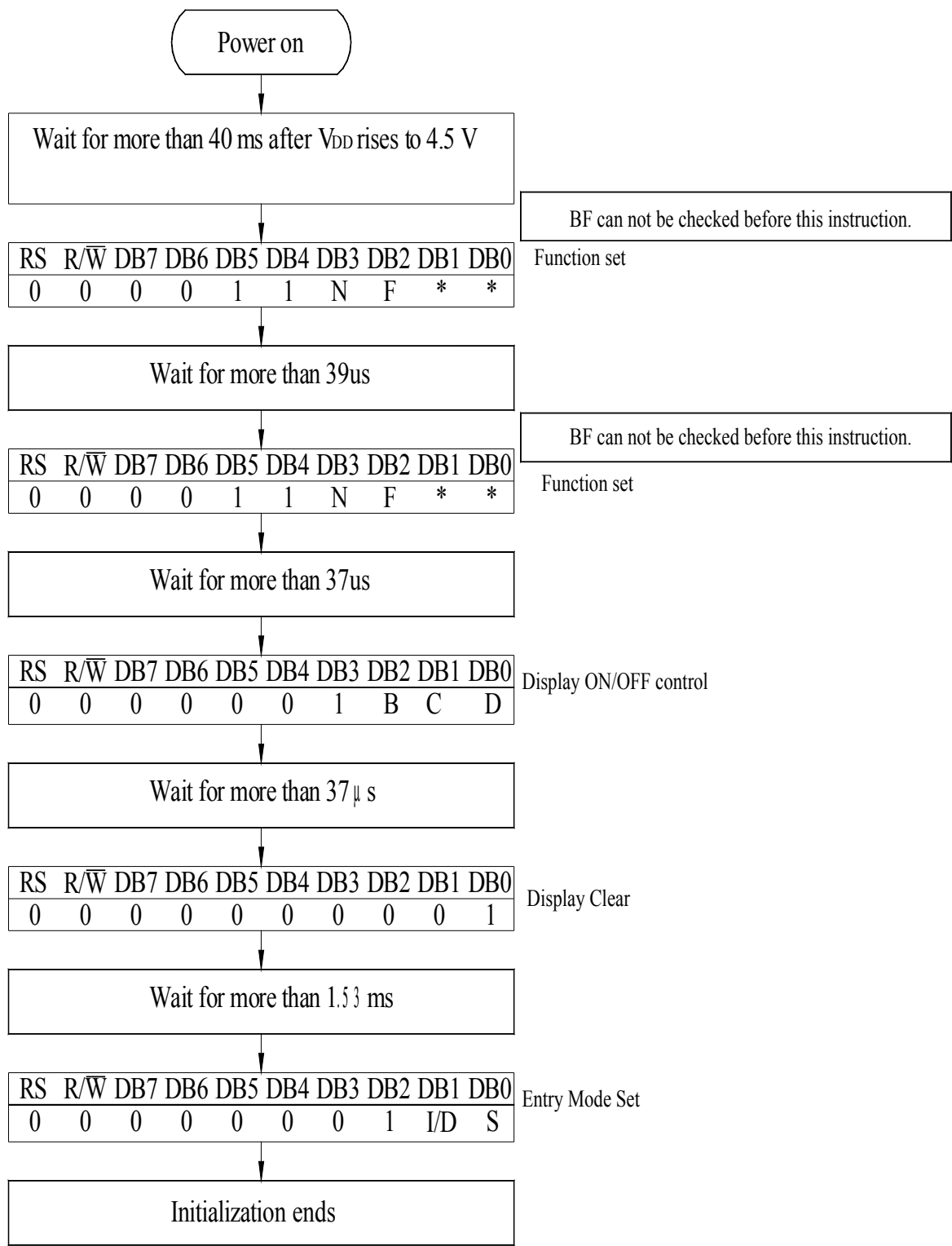

8-Bit Ineterface

# 14. Reliability

## Content of Reliability Test (wide temperature, -20°C~70°C)

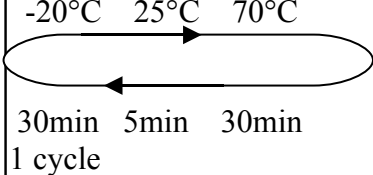
Environmental Test			
Test Item	Content of Test	Test Condition	Note
High Temperature storage	Endurance test applying the high storage temperature for a long time.	80°C 200hrs	2
Low Temperature storage	Endurance test applying the high storage temperature for a long time.	-30°C 200hrs	1,2
High Temperature Operation	Endurance test applying the electric stress (Voltage & Current) and the thermal stress to the element for a long time.	70°C 200hrs	—
Low Temperature Operation	Endurance test applying the electric stress under low temperature for a long time.	-20°C 200hrs	1
High Temperature/ Humidity Operation	The module should be allowed to stand at 60%, 90%RH max For 96hrs under no-load condition excluding the polarizer, Then taking it out and drying it at normal temperature.	60°C, 90%RH 96hrs	1,2
Thermal shock resistance	The sample should be allowed stand the following 10 cycles of operation  1 cycle	-20°C/70°C 10 cycles	—
Vibration test	Endurance test applying the vibration during transportation and using.	Total fixed amplitude : 1.5mm Vibration Frequency : 10~55Hz One cycle 60 seconds to 3 directions of X,Y,Z for Each 15 minutes	3
Static electricity test	Endurance test applying the electric stress to the terminal.	VS=800V, RS=1.5kΩ CS=100pF 1 time	—

**Note1: No dew condensation to be observed.**

**Note2: The function test shall be conducted after 4 hours storage at the normal Temperature and humidity after remove from the test chamber.**

**Note3: Vibration test will be conducted to the product itself without putting it in a container.**

# 15. Material List of Components for RoHs

1. Crystalfontz America, Inc. hereby declares that all of or part of products (with the mark “#”in code), including, but not limited to, the LCM, accessories or packages, manufactured and/or delivered to your company (including your subsidiaries and affiliated company) directly or indirectly by our company (including our subsidiaries or affiliated companies) do not intentionally contain any of the substances listed in all applicable EU directives and regulations, including the following substances.

Exhibit A: The Harmful Material List

Material	(Cd)	(Pb)	(Hg)	(Cr6+)	PBBs	PBDEs
Limited Value	100	1000	1000	1000	1000	1000
	ppm	ppm	ppm	ppm	ppm	ppm
Above limited value is set up according to RoHS.						

2.Process for RoHS requirement:

(1) Use the Sn/Ag/Cu soldering surface□the surface of Pb-free solder is rougher than we used before.

(2) Heat-resistance temp.

Reflow: 250°C,30 seconds Max.

Connector soldering wave or hand soldering: 320°C, 10 seconds max.

(3) Temp. curve of reflow, max. Temp.: 235±5°C

Recommended customer’s soldering temp. of connector: 280°C, 3 seconds.